

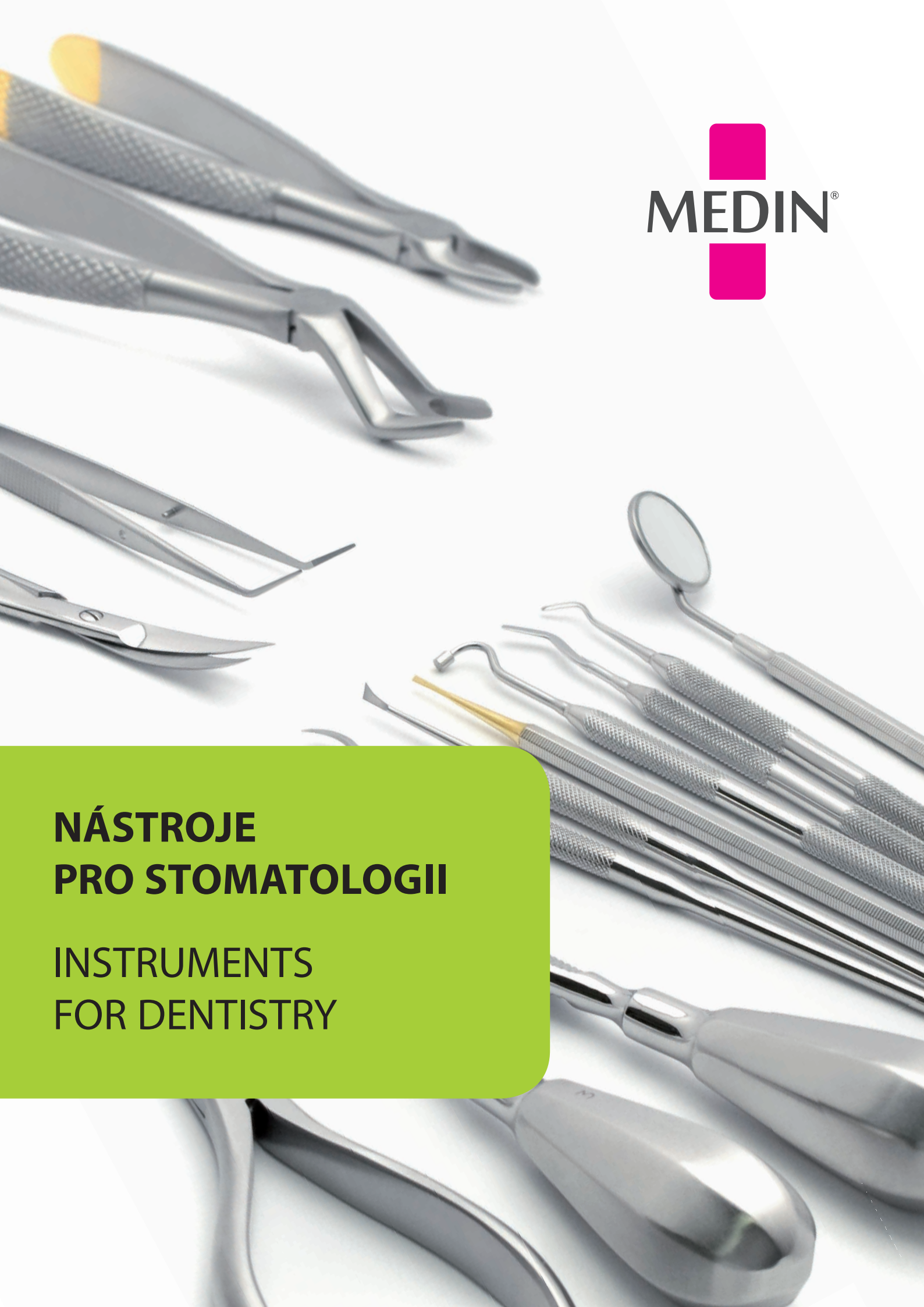

NÁSTROJE PRO STOMATOLOGII

**INSTRUMENTS
FOR DENTISTRY**





MEDIN, a.s.
Vlachovická 619
Nové Město na Moravě
CZ 592 31
Czech Republic
IČ 43378030
DIČ CZ43378030

PRODEJ ČESKÁ REPUBLIKA

tel.: 566 684 327
fax: 566 684 384
e-mail: prodej@medin.cz

EXPORT

phone: +420 566 684 336
fax: +420 566 684 385
e-mail: export@medin.cz

www.medin.cz
www.medin.eu

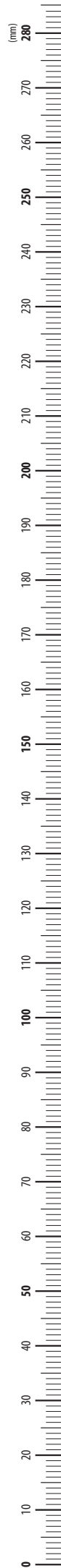

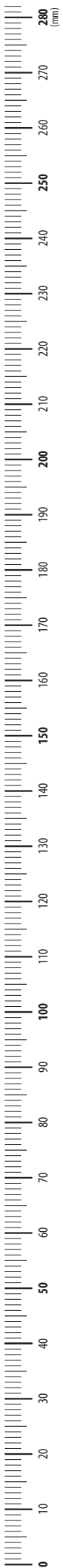

© 2016 MEDIN, a.s.; Všechna práva vyhrazena.

Dokument je určen pro obchodní účely MEDIN, a.s., údaje zde uvedené jsou informativního charakteru.

Žádná část tohoto dokumentu nesmí být reprodukována nebo publikována v jakékoliv formě bez předchozího souhlasu MEDIN, a.s. Zobrazení produktů odpovídá aktuálnímu stavu v době vydání tohoto dokumentu. Změny technických parametrů z důvodu dalšího vývoje jsou vyhrazeny.

Tiskové a typografické chyby jsou vyhrazeny.

© 2016 MEDIN, a.s.; All rights reserved.

This document should be used for commercial purposes of MEDIN, a.s.; the data mentioned in the document has informative character. No part of this document can be copied or published in any form without approval of MEDIN, a.s.

The product design may differ from those depicted in these illustrations at the date of issue. Adjustments, made from the reason of further developments of technical parameters, are reserved.

Printing and typographical errors are reserved.

Od zubních vrtáčků po špičkové traumatologické implantáty MEDIN

MEDIN, a.s., je tradičním českým výrobcem lékařských nástrojů a implantátů. Portfolio firmy tvoří produkty pro traumatologii, chirurgii, stomatologii a ortopedii. Společnost dodává své výrobky do desítek zemí celého světa.

Zahájení výroby a budování podniku

Chirana

Budoucnost jedné z předních společností České republiky se začala psát dne 29. srpna 1948, kdy byl v Novém Městě na Moravě položen **základní kámen závodu Chirana**. V roce 1949 byla zahájena výroba zubních vrtáčků a fréz pro zubní laboratoře.



V únoru 1950 rozšířila Chirana své **portfolio o chirurgii**. Do výrobního programu bylo zařazeno 25 druhů nejběžnějších chirurgických nástrojů. Ve stejném roce Chirana **poprvé exportuje** své výrobky, a sice do Bulharska, Rumunska a Německa.



Roku 1957 byl podnik rozšířen začleněním firmy Diamantrob, která se zabývala patentově chráněnou výrobou diamantových nástrojů pro zubní lékaře. Chirana pod své vedení vzala také firmu Pelc-Tyrolka a firmu Koutný, produkující speciální nástroje pro chirurgii. **V roce 1968 byl zřízen holding Chirana Nové Město.**



Počátkem 70. let dominovala snaha o rozšíření výroby. Výsledkem bylo více než 5 milionů vyrobených vrtáčků, počátkem 80. let až 9 milionů vrtáčků. Výroba pokrývala také přes 4 tisíce druhů chirurgických nástrojů.

Do výrobního programu byl v roce 1990 zařazen **obor traumatologie**.

Privatizace a vznik společnosti MEDIN

V roce 1992 byl státní podnik Chirana zařazen do první vlny privatizace a dne 24. března 1992 vznikla akciová společnost MEDIN, právní nástupce státního závodu Chirana. V té době byla firma MEDIN vlastněná 154 zaměstnanci podniku.



Dne 23. března 2006 koupila společnost MEDIN firmu WALTER Medica a následně ji přejmenovala na MEDIN Orthopaedics, a.s. Společnost MEDIN tím rozšířila své **portfolio o ortopedii**.



V roce 2010 byla založena v Rusku dceřiná společnost MEDIN RU. Společnost MEDIN se od roku 2011 prezentuje novým logem.



MEDIN získal v roce 2012 druhou dceřinou společnost, a sice založením firmy MEDIN Slovensko. V roce 2013 došlo k propojení obchodní sítě MEDIN s firmou ProSpon, spol. s r.o. a MEDIN se tak stal výhradním distributorem ortopedických výrobků společnosti ProSpon. Dne 14. března 2014 zvítězil MEDIN, a.s., v soutěži Česká inovace v kategorii Inovativní firma. Ocenění se váže k patentovanému patnímu hřebu C-NAIL.

Školení lékařů

Vedle vlastní kvalitní výzkumné a vývojové základny je nezbytným předpokladem inovativnosti firmy a uplatnění svých produktů v náročných podmínkách trhu schopnost

poskytovat kvalitní doprovodné služby. Jednou z těchto služeb, kterým se společnost MEDIN úspěšně věnuje, je pořádání odborných školení, praktických workshopů a seminářů zejména pro mladé lékaře a další zdravotnický personál. Tato vzdělávání probíhají v úzké spolupráci s firmou SOGGIORNO, s.r.o., v rámci celoživotního vzdělávání zdravotníků formou výuky operačních postupů s novými nebo inovovanými produkty firmy.



Odborné semináře vedou špičkoví a vysoce uznávaní lékaři zejména v oborech traumatologie, ortopedie a chirurgie, s nimiž se firmě podařilo navázat úspěšnou dlouhodobou spolupráci.

Školení je zajišťováno ve školicím středisku přímo v areálu společnosti MEDIN nebo v prostředí klienta.

Jaké hodnoty vám předáváme společně s výrobky?



Každý nástroj či implantát projde během zpracování rukama řady lidí a jeho výroba trvá až několik hodin. Nese tak s sebou i kus naší filozofie a základních hodnot.

Kompletní nákup chirurgických nástrojů. Ze široké nabídky firmy MEDIN jsme si dokázali velmi dobře vybrat."

Mgr. Renáta Michalíčková, staniční sestra
op. sálů, Thomayerova nemocnice Praha

Celá cesta výrobu, od vlastního vývoje po distribuci, má jediný cíl. Dát lékařům do rukou kvalitní nástroj, který usnadní operační zákrok a pomůže při jejich vlastní práci.

life. Most of the items prices are reasonable. We have been dealing with MEDIN for 6 years."

A. A. Zahar, Sala Medical, Oman

Zkoušky tvrdostí výrobku

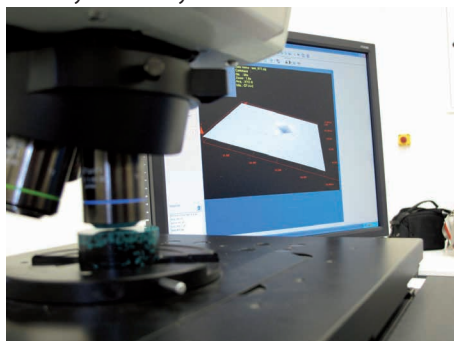

„Komunikace je na velké úrovni a skoro vše vyřídí jeden telefonát a to s velkou ochotou.“

Markéta Adamová, staniční sestra ORT
op. sály, Nemocnice Rudolfa a Stefanie Benešov
„MEDIN instruments are good quality and long

Zákazník

Našimi konečnými zákazníky jsou lékaři a zdravotní sestry z oborů chirurgie, traumatologie, ortopedie a stomatology. Snažíme se, aby řešení, která zákazníkům přinášíme, co nejvíce kopirovala jejich potřeby.

Testování nového instrumentária



Užitná hodnota výrobku

Naše okolí

Uvědomujeme si, že každá lidská činnost přináší změny v životním prostředí. Proto aplikujeme systém environmentálního managementu EMS. V rámci modelu Plan – Do – Check – Act Cycle neustále zkoumáme jednotlivé postupy ve firmě a hledáme ekologicky šetrnější varianty.

Sídlo naší společnosti se nachází v Novém Městě



na Moravě, v dějišti řady sportovních událostí

Certifikáty



From tooth drills to top-class traumatology implants MEDIN

MEDIN, a.s., is a traditional Czech producer of medical instruments and implants. The company's portfolio consists of products for traumatology, surgery, dentistry and orthopaedics. The company exports its products to dozens of countries around the world.

The start of production and building Chirana

The future of one of the leading companies in the Czech Republic began on 29 August 1948, when the **foundation stone of the** Chirana works was laid in Nové Město na Moravě. In 1949, production started on dental drills and milling cutters for dental laboratories.



In February 1950 Chirana expanded its **portfolio to surgery**. 25 of the most common surgical instruments were included in the production programme. In the same year Chirana **first exported** its products, namely to Bulgaria, Romania and Germany.



In 1957 the company expanded by incorporating Diamantrob, which was involved in the patented production of diamond tools for dentists. Chirana also took Pelc-Tyrolka and Koutný, companies producing special tools for surgery, under its management. **The Chirana Nové Město holding was set up in 1968.**



The early 1970s were dominated by an endeavour to expand production. The result was the manufacture of over 5 million drills, in the early 80's this had increased to 9,000,000 drills. Production covered over 4,000 kinds of surgical instruments. The field of traumatology was introduced into the production programme in 1990.

Privatization and the emergence of MEDIN

In 1992, the state enterprise Chirana was included in the first wave of privatization and on 24 March 1992 the joint-stock company MEDIN was founded, the legal successor to the state-owned Chirana. At the time, MEDIN was owned by 154 company employees.



On 23 March 2006, MEDIN bought WALTER Medica and subsequently changed its name to MEDIN Orthopaedics, a.s. This allowed MEDIN to expand its **portfolio to orthopaedics**.



In 2010 a subsidiary, MEDIN RU, was founded in Russia. Since 2011 MEDIN has had a new logo.



In 2012 MEDIN gained a second subsidiary, namely through the founding of MEDIN Slovensko. In 2013 the MEDIN business network was linked to ProSpon, spol. s r.o. and MEDIN became the exclusive distributor of orthopaedic products for ProSpon. On 14 March 2014 MEDIN, a.s., won the Czech Innovation contest in the Innovative Company category. The award is for C-NAIL a patented calcaneal nail.

Training doctors

Besides its high-quality research and development programme, the provision of good-quality services is a prerequisite of a company's innovation and its ability to sell its products in the demanding conditions of today's market. One of these

services, which MEDIN has had great success in, is the organization of professional training, practical workshops and seminars especially for young physicians and other medical personnel. This training takes place in close cooperation with SOGGIORNO, s.r.o., as part of lifelong education for health care professionals and takes the form of training in operating procedures with new or innovated products from the company.



Professional seminars are led by leading and highly respected doctors, in particular in the fields of orthopaedics, traumatology and surgery, with whom the company has been able to establish successful, long-term cooperation.

Training is provided in the training centre directly at MEDIN or at the client's premises.

What is the added value we offer with our products?



During processing, each instrument or implant passes through the hands of a number of people and takes up to several hours to produce. As such it carries a part of our philosophy and basic principles with it.

"Our operating theatres are brand new which meant purchasing a full range of surgical instruments. We were spoilt for choice from the wide offer range provided by MEDIN."

MSc Renáta Michalíčková, Head Nurse for operating theatre at Thomayer's Hospital, Prague.

Useful product value

Throughout the journey of making a product, from actual development right up until distribution, there is only one goal – to provide doctors with a quality instrument which will facilitate the operation procedure and assist them in their own work.

"Medin instruments are good quality and long lasting. Most prices of items are reasonable. We have been dealing with Medin for 6 years."

A. A. Zahar, Sala Medical, Oman

Customer

Our end customers are doctors and nurses from the fields of surgery, traumatology, orthopaedics and stomatology. We try to ensure that the solutions we deliver to customers match their needs as closely as possible.



Testing of new instrumentaria

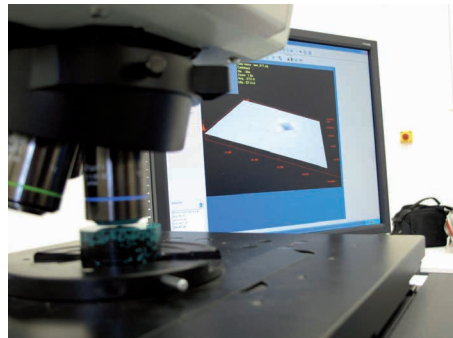

Tests on product hardness

"Communication is of the highest level and is almost always dealt with over one phone call and with a great sense of willingness"

Markéta Adamová, Head Nurse ORT operating theatre, Rudolf and Stephanie Hospital, Benešov

Our surroundings

We are aware that all human activity is accompanied by changes in our environment. For this reason we have put in place a system of environmental management called EMS. As part of our Plan – Do – Check – Act Cycle model, we are constantly exploring individual processes in the company and looking for options which demonstrate greater consideration to the environment.



Our head offices are located in Nové Město na Moravě, venue of sporting events

Certificates



A	Extrakce a chirurgie	Extraction and Surgery	9–70
B	Diagnostika	Diagnostics	71–76
C	Záchovná stomatologie	Restorative	77–98
D	Parodontologie	Periodontia	99–112
E	Laboratoř	Laboratory	113–132
F	Sterilizace a pomocné vybavení	Sterilization and Accessories	133–146
	Číselný rejstřík	Numerical Index	147–168
	Jmenný rejstřík	Alphabetical Index	169–174

A

EXTRAKCE A CHIRURGIE
EXTRACTION AND SURGERY



Kleště extrakční	Extraction Forceps	11–15
Kleště štípací	Bone Rongeurs	16–18
Kleště úchopné	Grasping Forceps	19
Páčidla	Elevators	20
Páky extrakční	Root Elevators	21–25
Škrabky	Raspatories	26
Pilníky	Rasps	27
Dláta	Chisels	28–29
Kladívka	Mallets	30
Háky	Hooks, Retractors	31–36
Chrániče prstu	Finger Protectors	36
Rozvěrače úst	Mouth Retractors	37
Lžičky	Bone Curettes, Spoons	38–40
Nástroje řezné	Cutting Instruments	40–41
Držátka skalpelových čepelí	Scalpel Handles	42
Skalpelové čepelky	Scalpel Blades	43
Svorky	Clamps, Forceps	44–49
Jehelce	Needle Holders	50–53
Zavaděče	Introducers	54
Dlahy dentální	Dental Plates	54
Nůžky	Scissors	55–63
Pinzety	Forceps	64–70

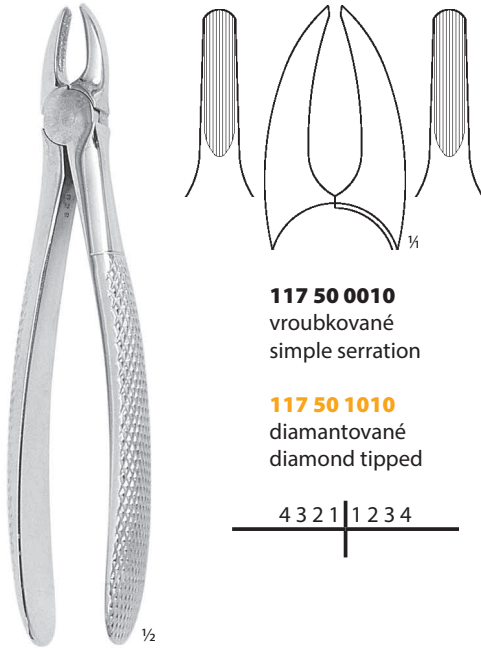

D2
na horní malé řezáky
for upper laterals
16,8 cm



D7
na horní premoláry
for upper premolars
16,4 cm

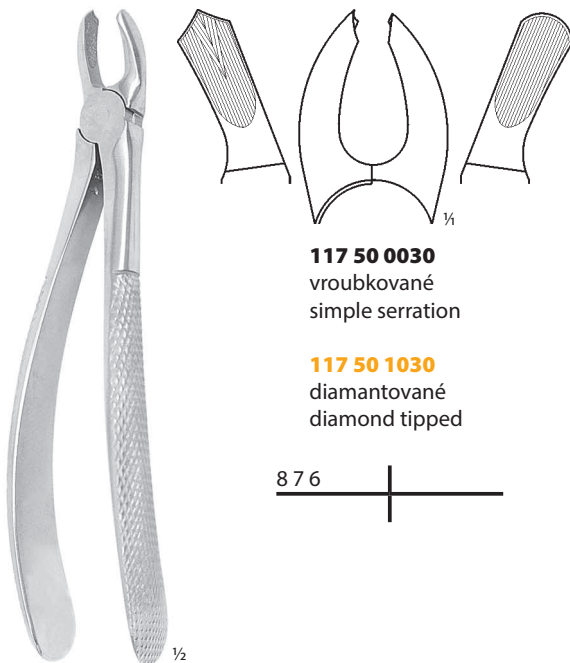

D17
na horní moláry pravé
for right upper molars
17,2 cm

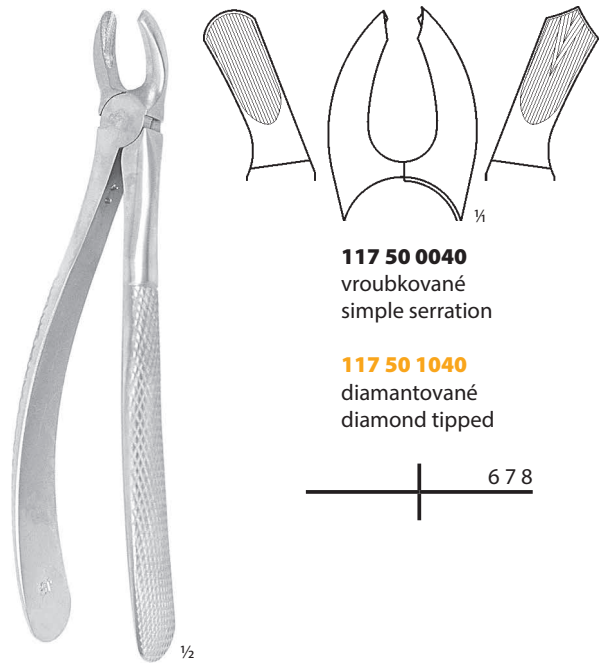

D18
na horní moláry levé
for left upper molars
17,2 cm

KLEŠTĚ EXTRAKČNÍ
EXTRACTION FORCEPS

117 50 0150
vroubkované
simple serration

117 50 1150
diamantované
diamond tipped

6 5 4 3 2 1 | 1 2 3 4 5 6

D13
na dolní premoláry
for lower premolars
15,0 cm



117 50 0160
vroubkované
simple serration

117 50 1160
diamantované
diamond tipped

7 6 | 6 7

D22
na dolní moláry
for lower molars
15,0 cm



117 50 0200
vroubkované
simple serration

117 50 1200
diamantované
diamond tipped

8 7 6 5 4 3 2 1 | 1 2 3 4 5 6 7 8

D33
na dolní kořeny široké
for lower roots broad
14,8 cm



117 50 0190
vroubkované
simple serration

117 50 1190
diamantované
diamond tipped

8 7 6 5 4 3 2 1 | 1 2 3 4 5 6 7 8

D33A
na dolní kořeny úzké
for lower roots
14,8 cm



117 50 0060
vroubkované
simple serration

117 50 1060
diamantované
diamond tipped

D30S
na horní kořeny
for upper roots
15,0 cm

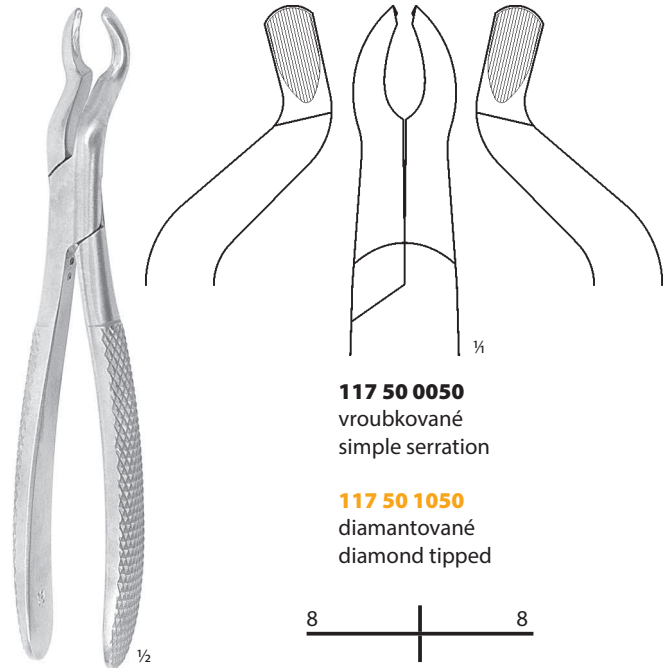

117 50 0050
vroubkované
simple serration

117 50 1050
diamantované
diamond tipped

D67
na horní 3. moláry
for upper wisdoms
17,4 cm

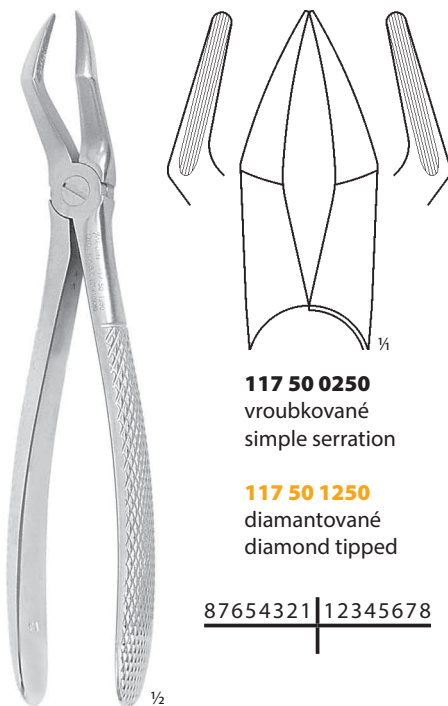

117 50 0250
vroubkované
simple serration

117 50 1250
diamantované
diamond tipped

D51A
bajonetové úzké
for upper roots narrow
18,2 cm

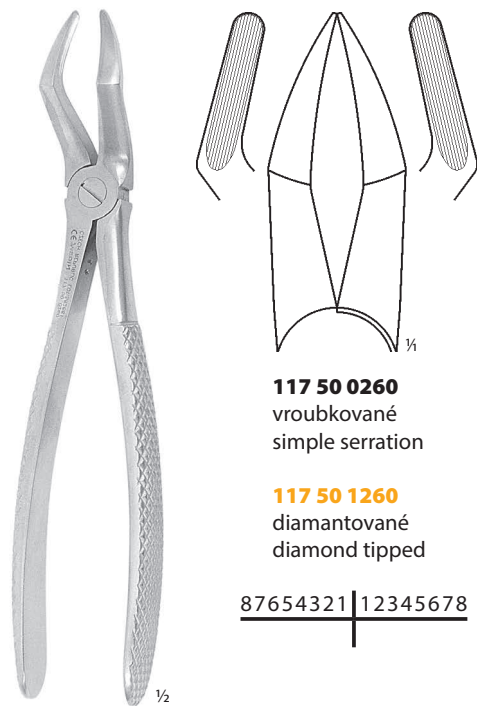

117 50 0260
vroubkované
simple serration

117 50 1260
diamantované
diamond tipped

D51
bajonetové široké
for upper roots broad
18,2 cm

KLEŠTĚ EXTRAKČNÍ
EXTRACTION FORCEPS

117 50 0170
vroubkované
simple serration

117 50 1170
diamantované
diamond tipped



D73
na dolní moláry
for lower molars
15,0 cm



117 50 0350
vroubkované
simple serration

117 50 1350
diamantované
diamond tipped



D74
na dolní kořeny
for lower roots
15,0 cm

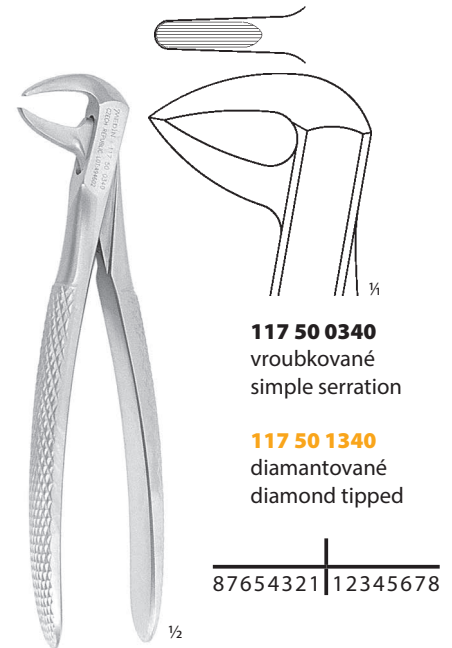

117 50 0340
vroubkované
simple serration

117 50 1340
diamantované
diamond tipped



D74M
na dolní kořeny
for lower roots
15,0 cm



117 50 0330
vroubkované
simple serration

117 50 1330
diamantované
diamond tipped

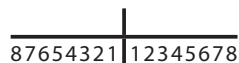

D74N
na dolní kořeny
for lower roots
15,0 cm

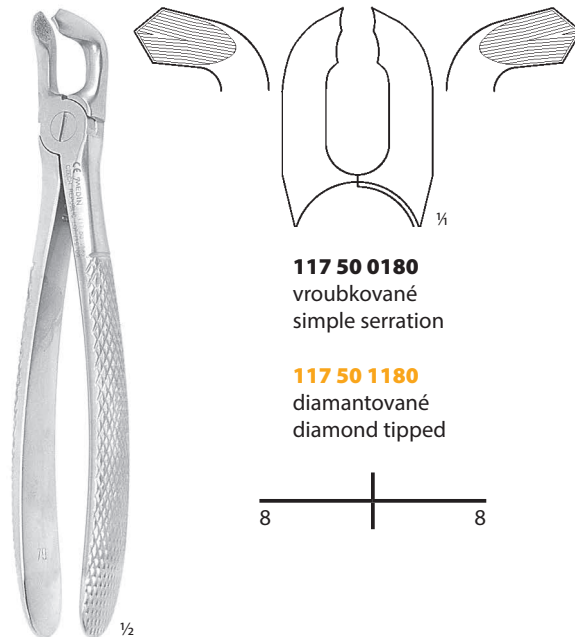

117 50 0180
vroubkované
simple serration

117 50 1180
diamantované
diamond tipped



D79
na dolní 3. moláry
for lower wisdoms
16,5 cm

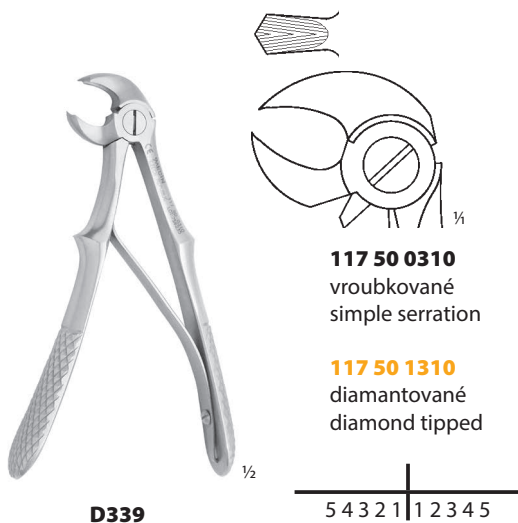

D339
na dolní moláry
for lower molars
10,7 cm



D342
na horní moláry
for upper molars
11,7 cm

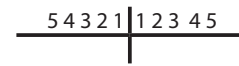

KLEŠTĚ K ODSTRANĚNÍ KOŘENOVÝCH NÁSTROJŮ
FORCEPS FOR EXTRACTION OF ROOT INSTRUMENTS



117 51 0600
rovné
straight
13,5 cm



117 51 1600
rovné, diamantované
straight, diamond tipped
13,5 cm



117 51 0610
zahnuté
curved
13,5 cm



117 51 1610
zahnuté, diamantované
curved, diamond tipped
13,5 cm

KLEŠTĚ ŠTÍPACÍ
BONE RONGEURS

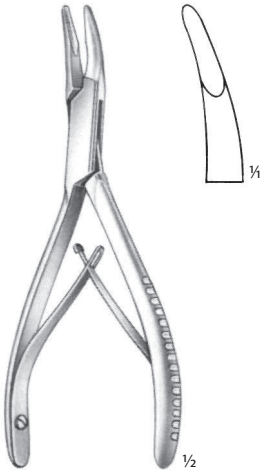

MINI-FRIEDMAN
116 91 0017
12,0 cm

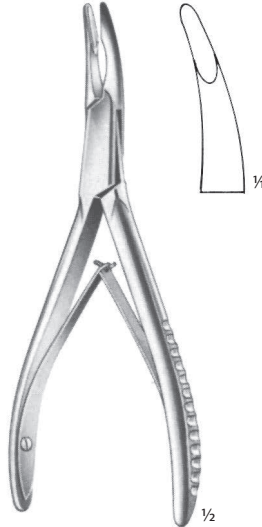

FRIEDMAN
116 91 0514
14,0 cm

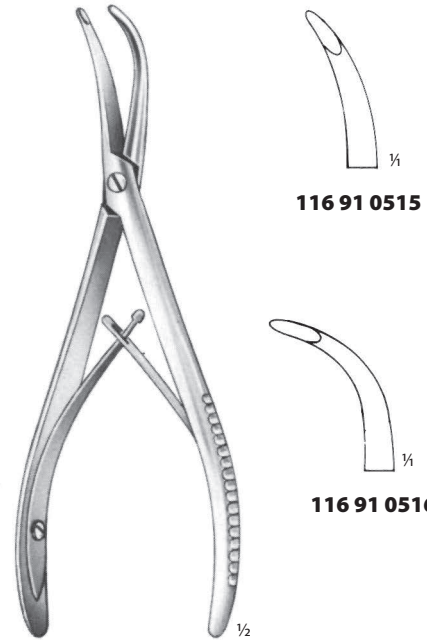

STELLBRINK
17,0 cm

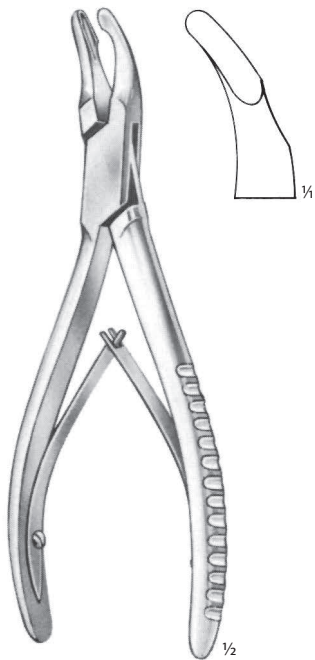

CLEVELAND
116 91 0518
17,0 cm

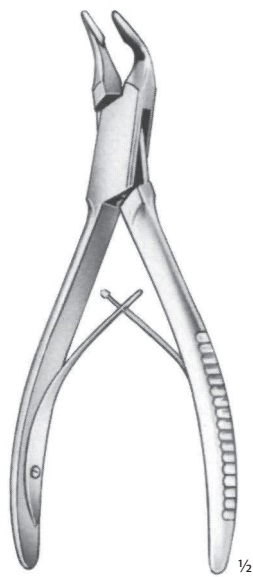

BLUMENTHAL
15,5 cm

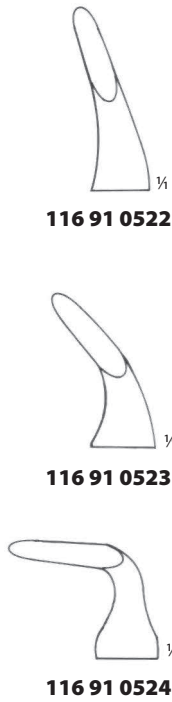

116 91 0522

116 91 0523

116 91 0524

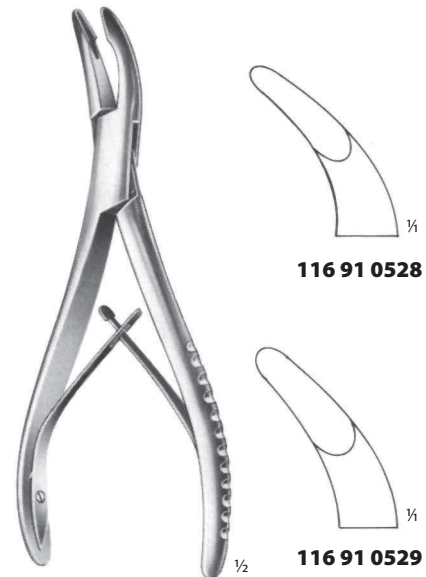

LUER
15,0 cm

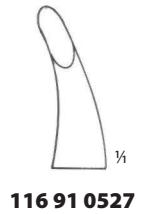

116 91 0527



116 91 0528

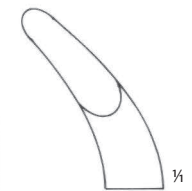

116 91 0529



LUER
116 08 0030
rovné
straight
17,0 cm

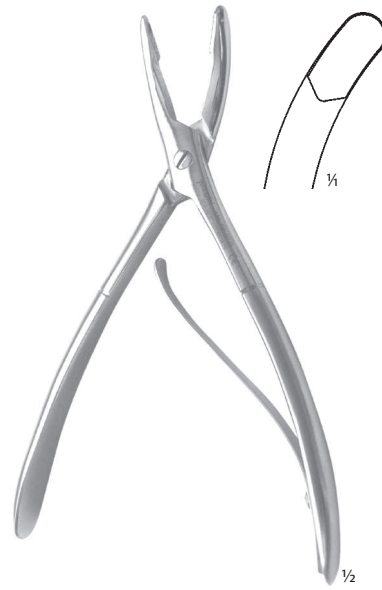

LUER
116 08 0070
zahnuté
curved
15,0 cm

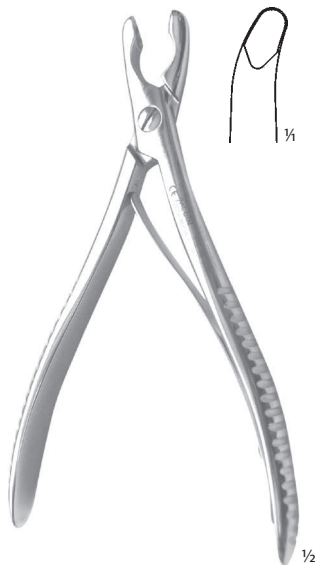

LUER
116 08 0080
zahnuté
curved
14,5 cm

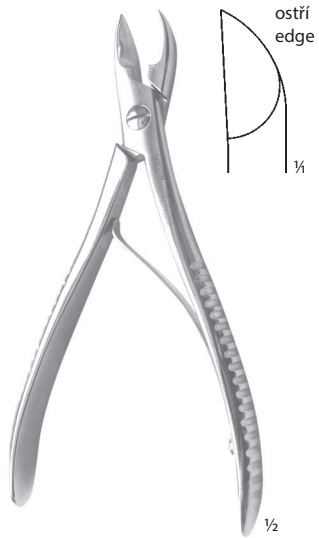

JANSEN
116 29 0410
zahnuté
curved
18,0 cm
Fig. 2

KLEŠTĚ ŠTÍPACÍ
BONE RONGEURS

116 08 0280
rovné
straight
14,0 cm

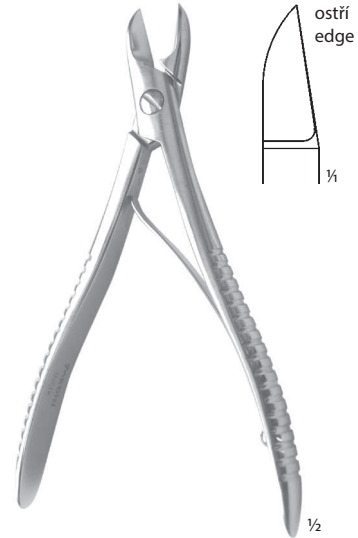

LISTON
116 08 0410
rovné
straight
14,0 cm

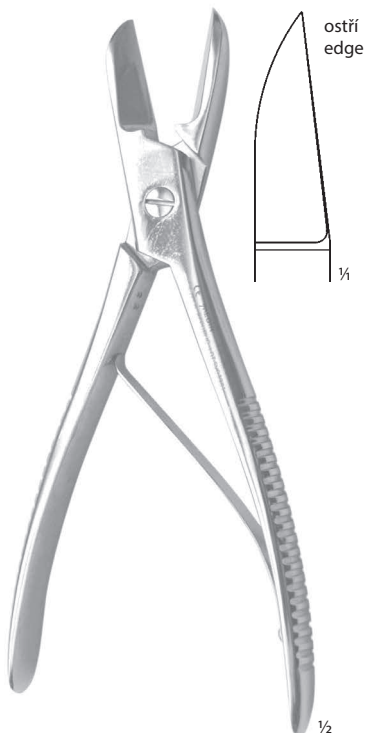

LISTON
116 08 0440
rovné
straight
19,0 cm

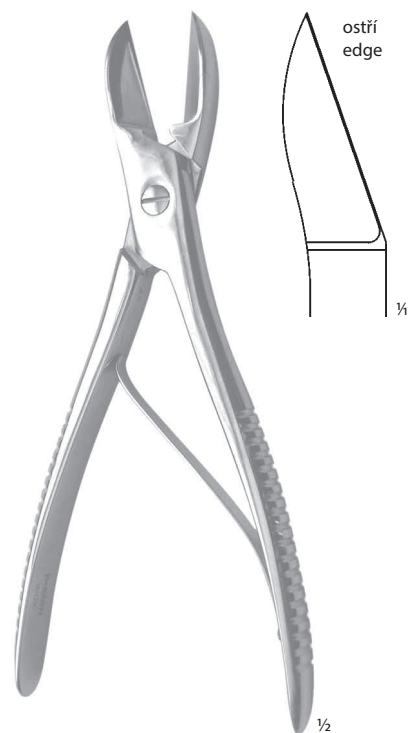

LISTON
116 08 0450
zahnuté
curved
19,0 cm

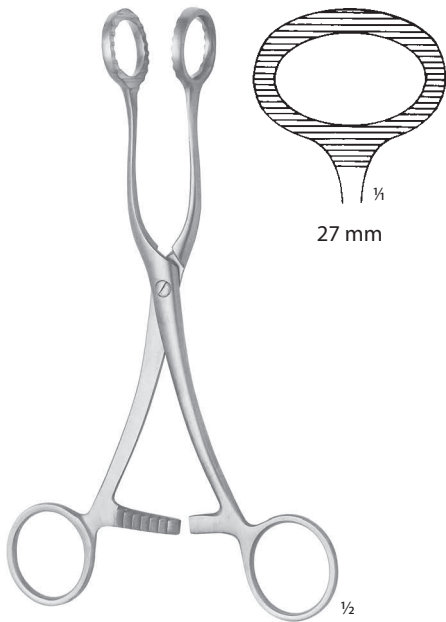

COLLIN
117 31 0010
16,7 cm

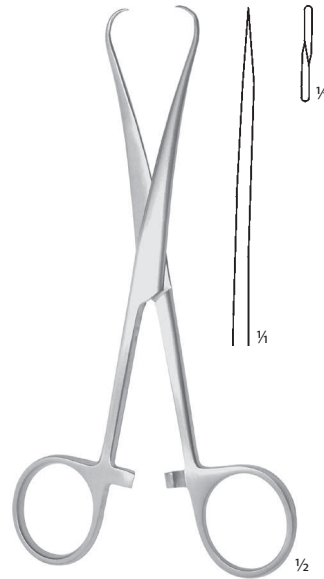

LÖBKER
117 31 0030
15,0 cm

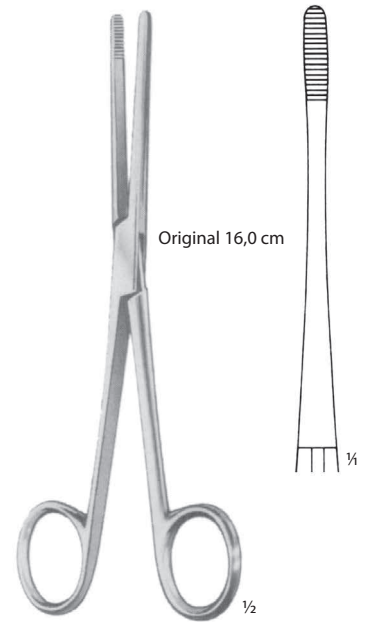

LISTER
117 91 0001 13,0 cm
117 91 0002 16,0 cm
117 91 0003 18,0 cm

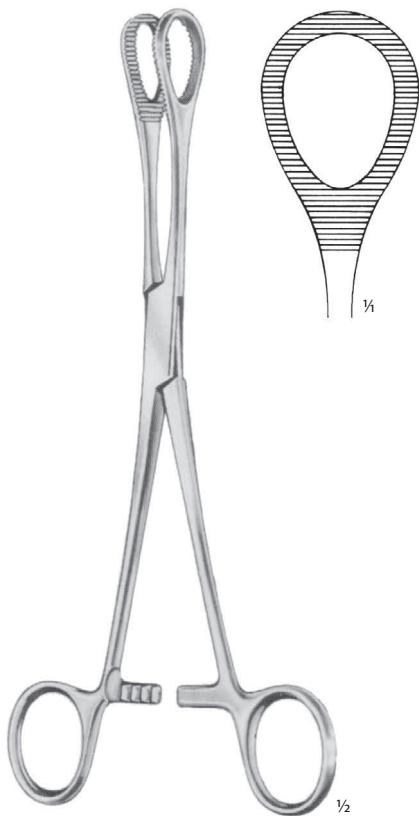

HEYWOOD-SMITH
117 91 0038
21,0 cm



HEYWOOD-SMITH
117 91 0039
25,0 cm



COLLIN
117 91 0033
24,0 cm

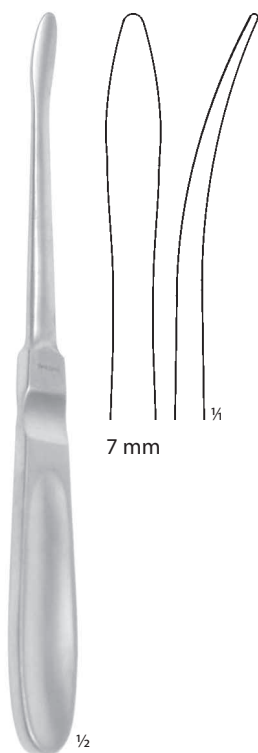

LANGENBECK
123 08 0010
19,5 cm
Fig. 1

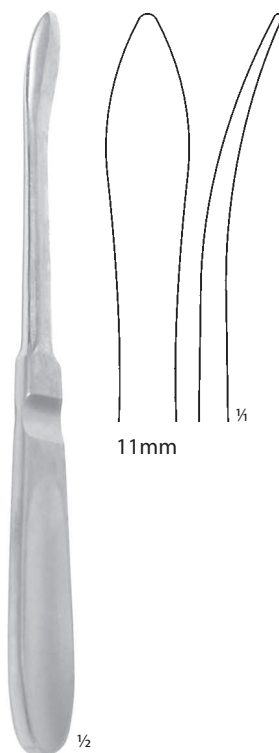

LANGENBECK
123 08 0020
19,5 cm
Fig. 2

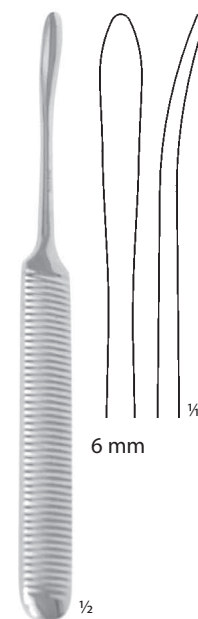

WILLIGER
123 08 0030
16,0 cm
Fig. 1

PÁČIDLA NOSNÍ
NASAL ELEVATORS



FREER
123 30 0030
17,9 cm



123 99 0084
17,0 cm



FREER
19,0 cm

123 91 0006
ostré
sharp

123 91 0007
tupé
blunt



FREER
123 91 0008
18,0 cm

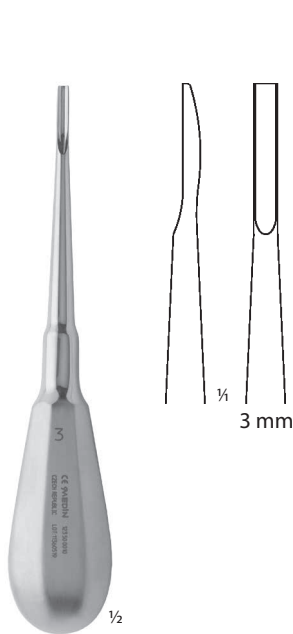

BEIN
123 50 0010
rovná
straight
14,5 cm



BEIN
123 50 0011
rovná
straight
16,5 cm

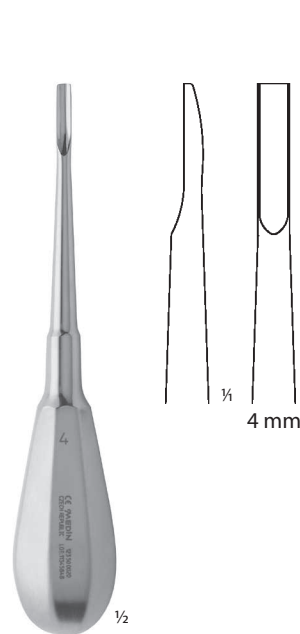

BEIN
123 50 0020
rovná
straight
14,5 cm



BEIN
123 50 0021
rovná
straight
16,5 cm

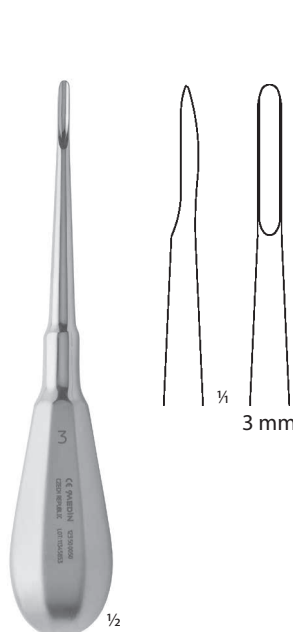

BEIN
123 50 0050
oblouková
embowed
14,5 cm



BEIN
123 50 0051
oblouková
embowed
16,5 cm

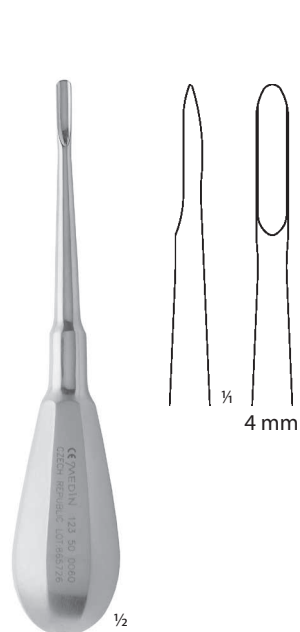

BEIN
123 50 0060
oblouková
embowed
14,5 cm

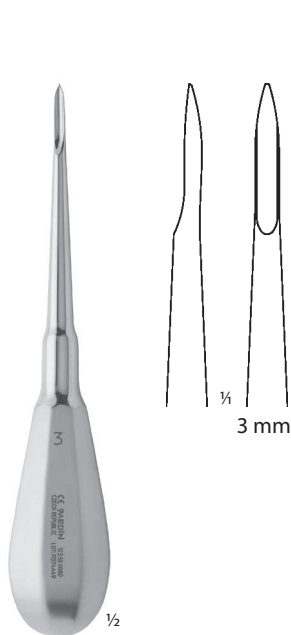

BEIN
123 50 0061
oblouková
embowed
16,5 cm

PÁKY EXTRAKČNÍ
ROOT ELEVATORS

BEIN
123 50 0080
rovná, jemná
straight, fine
14,5 cm



BEIN
123 50 0081
rovná, jemná
straight, fine
16,5 cm

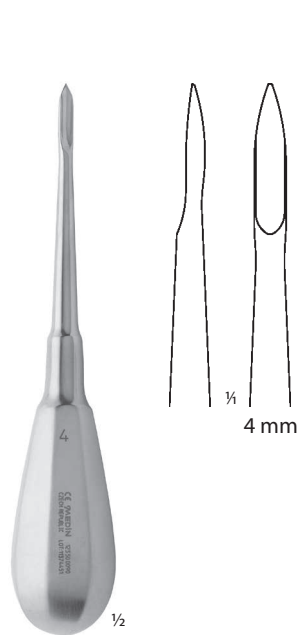

BEIN
123 50 0090
rovná, jemná
straight, fine
14,5 cm



BEIN
123 50 0091
rovná, jemná
straight, fine
16,5 cm

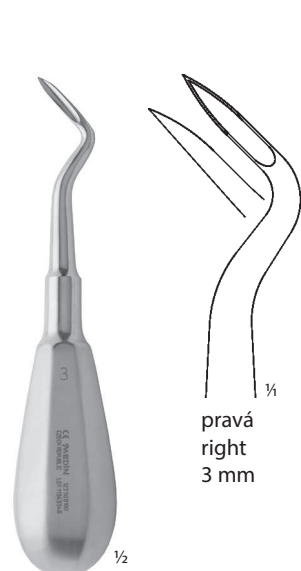

FLOHR
123 50 0100
hrotnatá, ostrá
pointed, sharp
13,0 cm



FLOHR
123 50 0101
hrotnatá, ostrá
pointed, sharp
15,0 cm

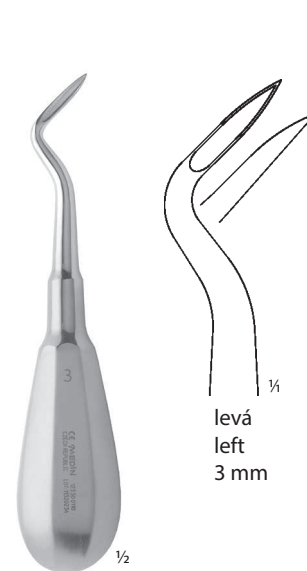

FLOHR
123 50 0110
hrotnatá, ostrá
pointed, sharp
13,0 cm



FLOHR
123 50 0111
hrotnatá, ostrá
pointed, sharp
15,0 cm

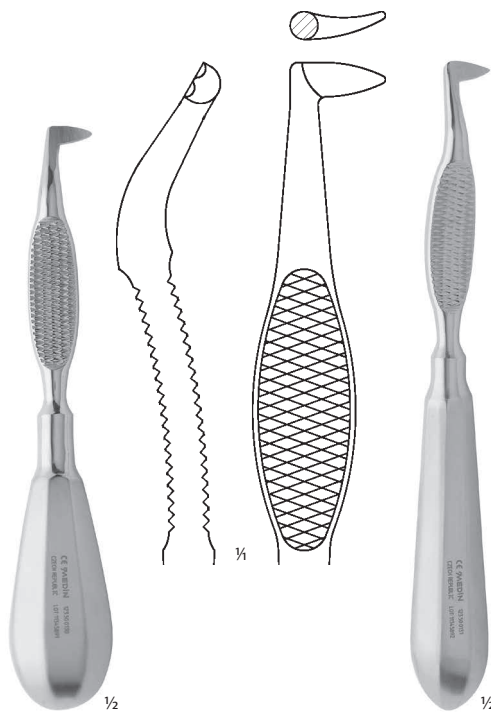

**SCHLEMMER
123 50 0130**
pravá
right
15,1 cm



**SCHLEMMER
123 50 0131**
pravá
right
17,1 cm

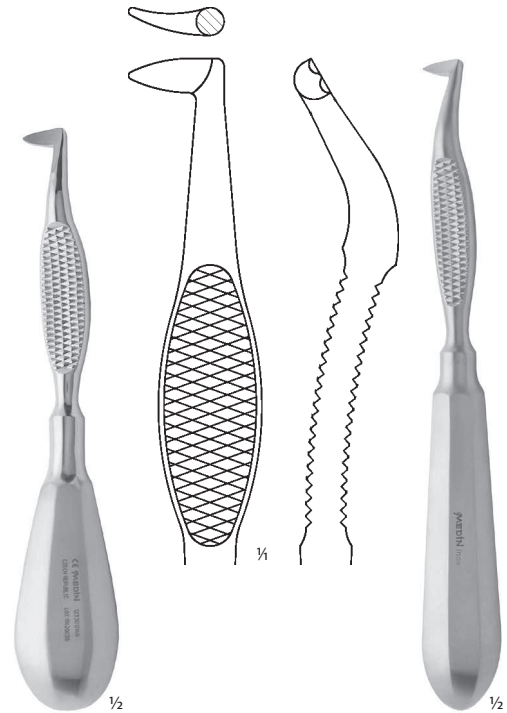

**SCHLEMMER
123 50 0140**
levá
left
15,1 cm



**SCHLEMMER
123 50 0141**
levá
left
17,1 cm

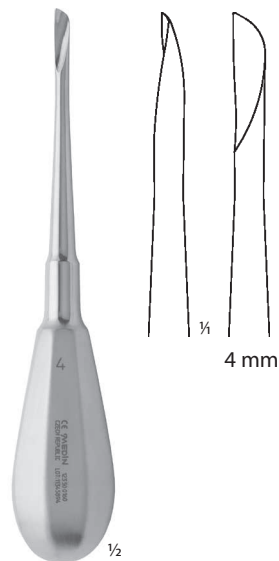

123 50 0160
rovná, pravá
straight, right
14,5 cm

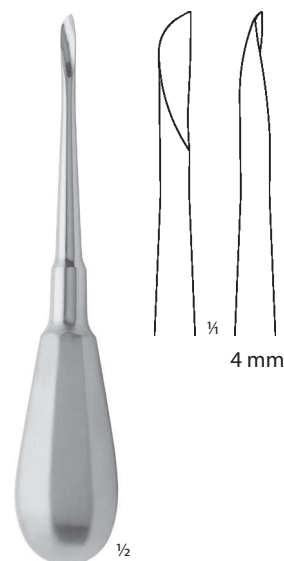

123 50 0170
rovná, levá
straight, left
14,5 cm

PÁKY EXTRAKČNÍ
ROOT ELEVATORS

ŠPINAR
123 50 0210
přední
frontal
14,8 cm

ŠPINAR
123 50 0211
přední
frontal
16,8 cm

ŠPINAR
123 50 0220
zadní
retal
14,8 cm

ŠPINAR
123 50 0221
zadní
retal
16,8 cm

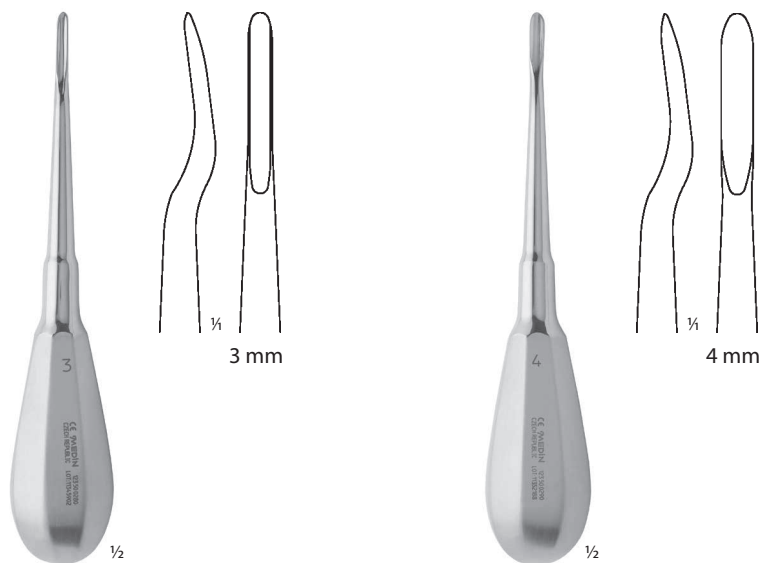

WHITE
123 50 0280
oblouková, vyhnutá
embowed, angled
14,5 cm

WHITE
123 50 0290
oblouková, vyhnutá
embowed, angled
14,5 cm

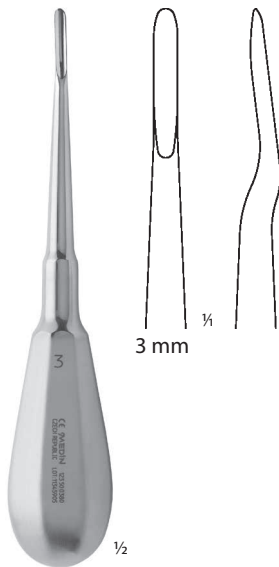

WHITE
123 50 0380
oblouková, vyhnutá
embowed, angled
14,5 cm

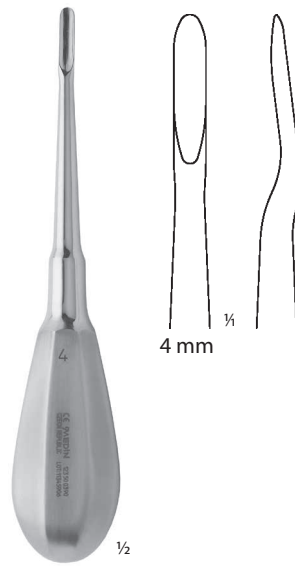

WHITE
123 50 0390
oblouková, vyhnutá
embowed, angled
14,5 cm

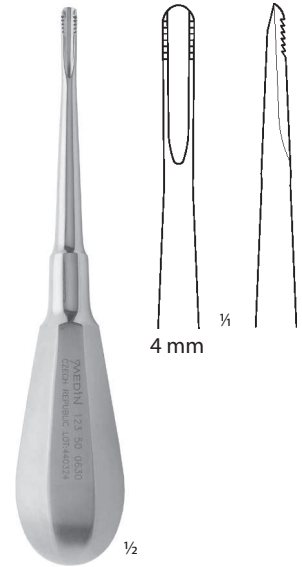

123 50 0630
se zuby, rovná
with saw, straight
14,5 cm

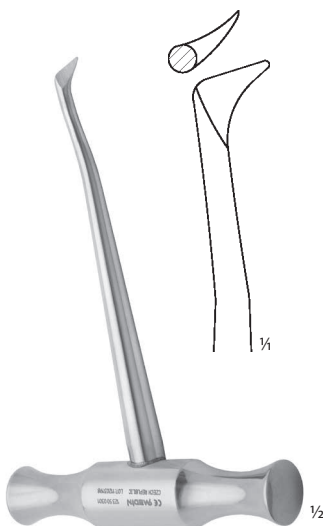

BARRY
123 50 0301
pravá
right
12,4 cm

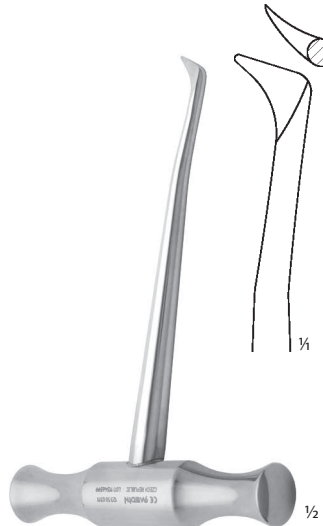

BARRY
123 50 0311
levá
left
12,4 cm

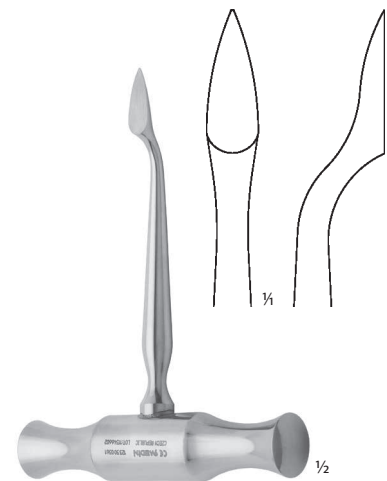

LECLUSE
123 50 0361
10,8 cm

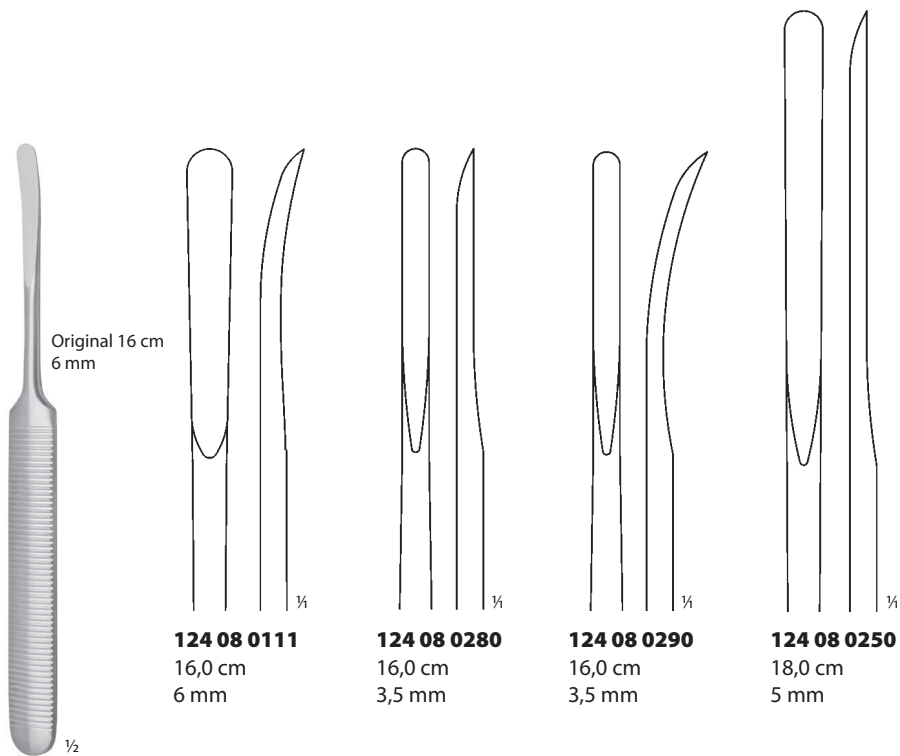

Original 16 cm
6 mm

124 08 0111
16,0 cm
6 mm

124 08 0280
16,0 cm
3,5 mm

124 08 0290
16,0 cm
3,5 mm

124 08 0250
18,0 cm
5 mm

WILLIGER
16,0 cm



13 mm

LANGENBECK
124 08 0120
20,5 cm

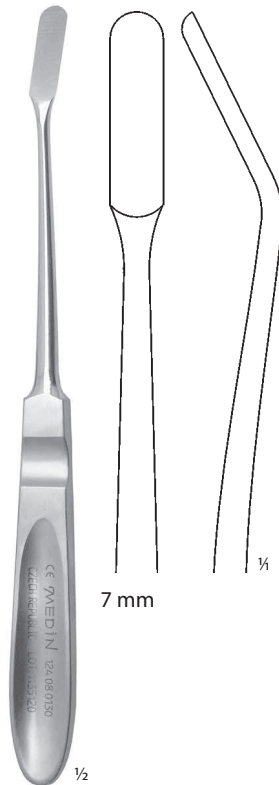

7 mm

LANGENBECK
124 08 0130
20,4 cm

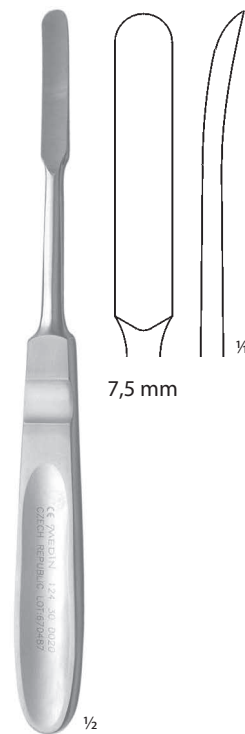

7,5 mm

PŘECEHTĚL
124 30 0020
19,0 cm

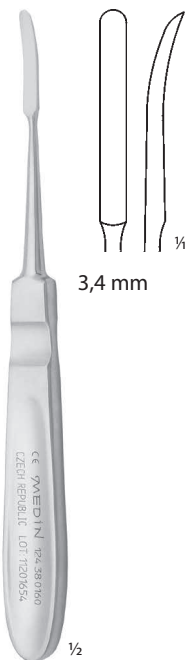

3,4 mm

124 38 0160
17,2 cm

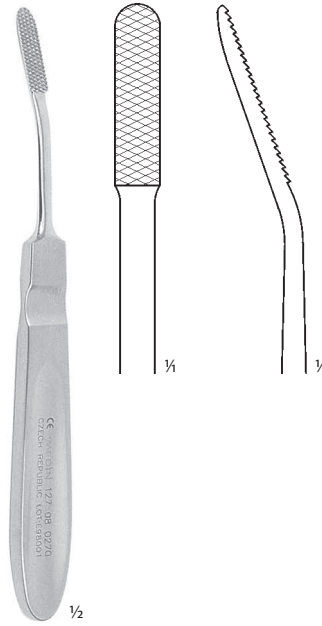

127 08 0270
15,9 cm

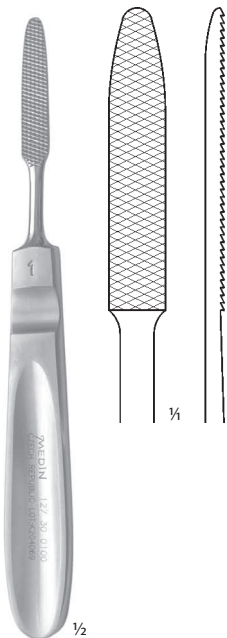

JOSEPH
127 30 0100
16,5 cm
Fig. 1

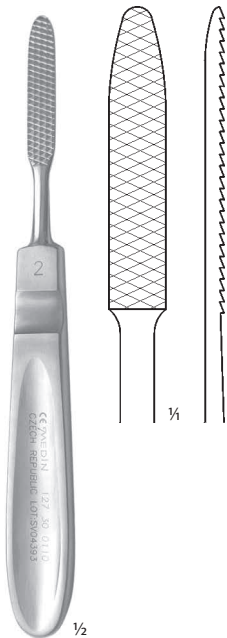

JOSEPH
127 30 0110
16,5 cm
Fig. 2

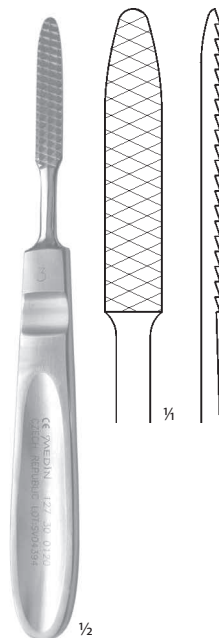

JOSEPH
127 30 0120
16,5 cm
Fig. 3

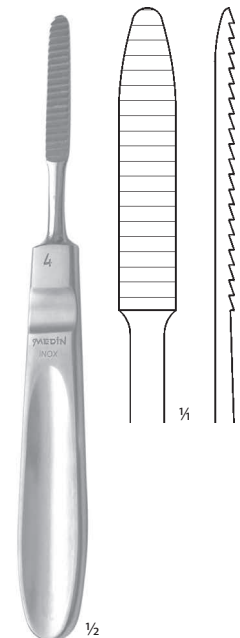

JOSEPH
127 30 0130
16,5 cm
Fig. 4

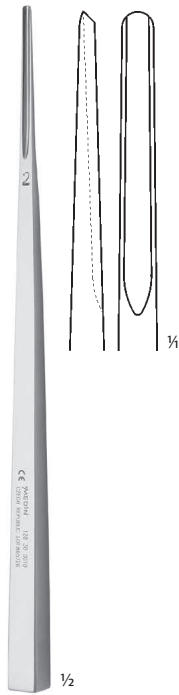

128 30 0010
18,0 cm
2 mm

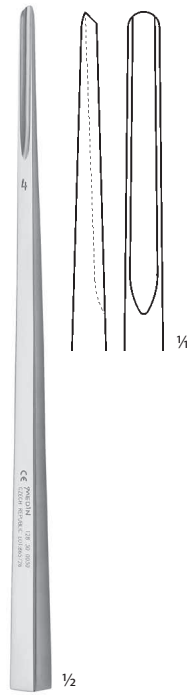

128 30 0030
18,0 cm
4 mm

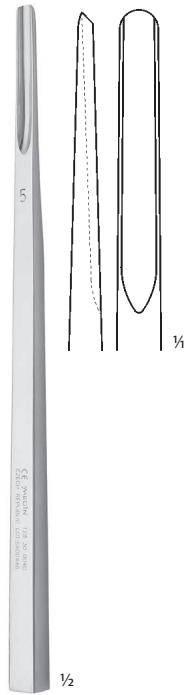

128 30 0040
18,0 cm
5 mm

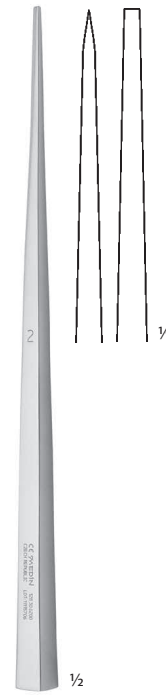

WEST
128 30 0200
18,0 cm
2 mm

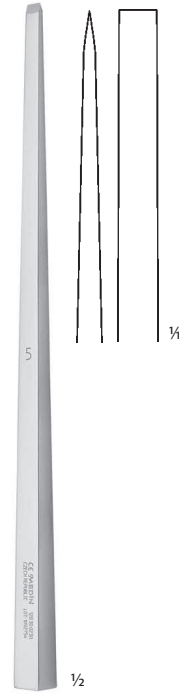

WEST
128 30 0230
18,0 cm
5 mm

DLÁTA JEMNÁ
CHISELS FINE



128 50 0050
ploché
flat
17,5 cm

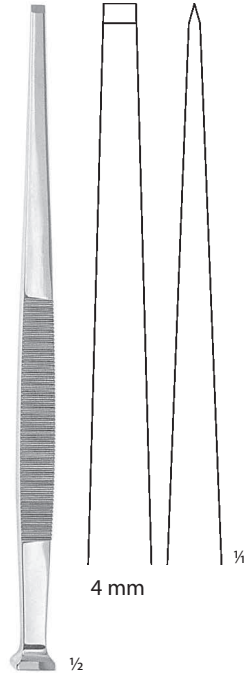

128 50 0060
ploché
flat
17,5 cm

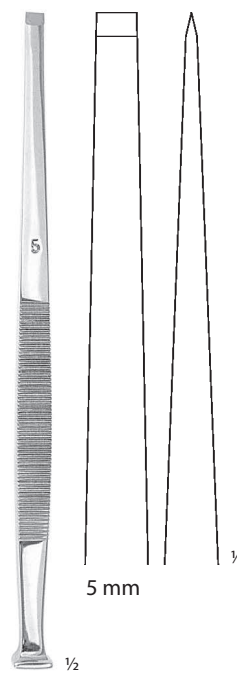

128 50 0070
ploché
flat
17,5 cm

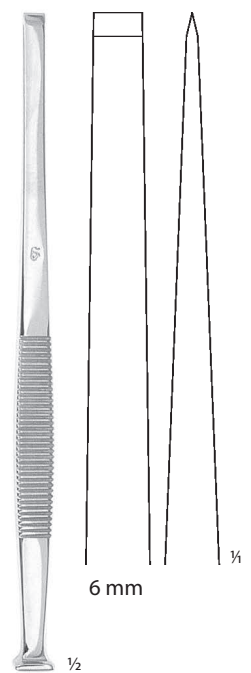

128 50 0080
ploché
flat
17,5 cm

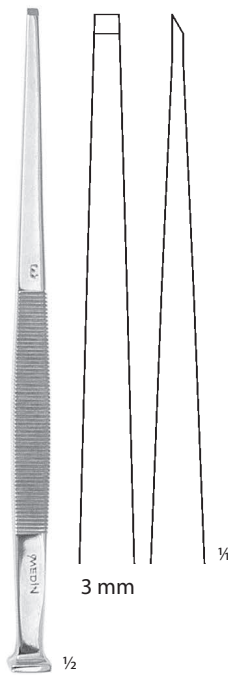

128 50 0110
poloklínové
half-wedged
17,5 cm

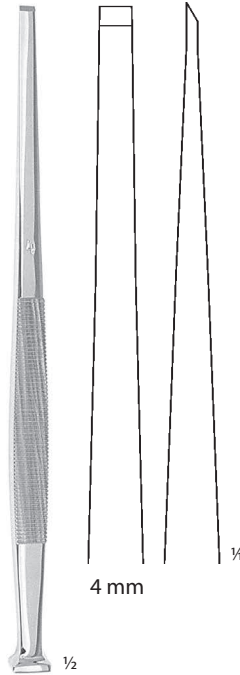

128 50 0120
poloklínové
half-wedged
17,5 cm

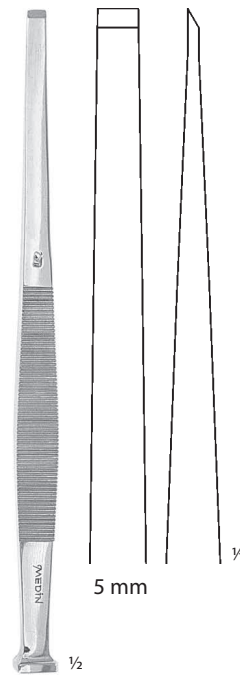

128 50 0130
poloklínové
half-wedged
17,5 cm

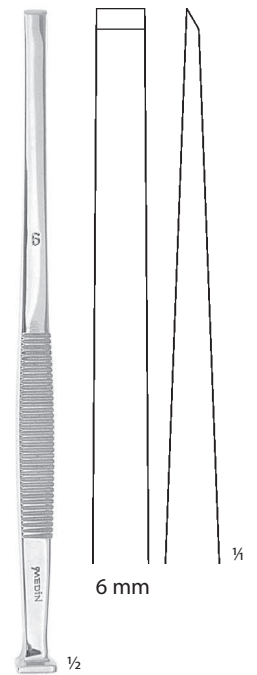

128 50 0140
poloklínové
half-wedged
17,5 cm

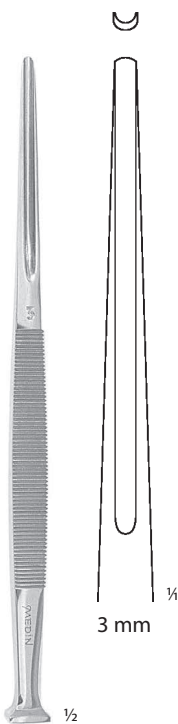

128 50 0200
žlábkové
grooved
17,5 cm

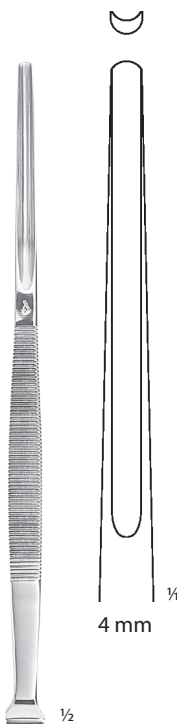

128 50 0210
žlábkové
grooved
17,5 cm

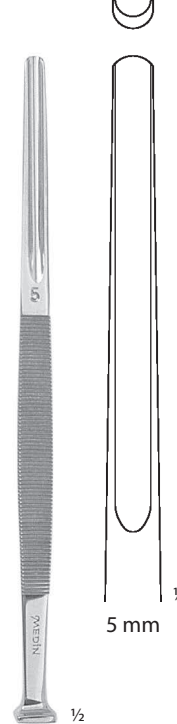

128 50 0220
žlábkové
grooved
17,5 cm

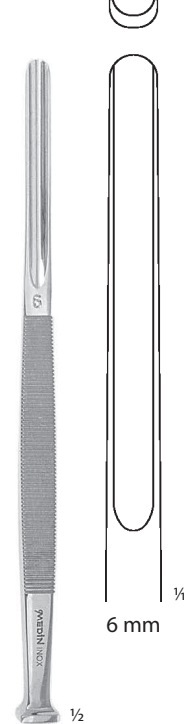

128 50 0230
žlábkové
grooved
17,5 cm



Kladívko chirurgické
Surgical mallet
128 08 0901
250 g
22,3 cm



Kladívko chirurgické
Surgical mallet
128 08 0911
500 g
23,5 cm



118 91 0027
16,0 cm



118 08 0010



118 08 0050



118 08 0020



118 08 0060



118 91 0027



118 91 0035



118 91 0028
ostrý
sharp



118 91 0036
tupý
blunt



118 91 0046
ohýbný
flexible
16,0 cm

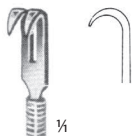

118 91 0045

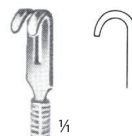

118 91 0048



118 91 0046



118 91 0049



118 91 0047
ostrý
sharp



118 91 0050
tupý
blunt



JOSEPH
118 91 0051
16,0 cm



JOSEPH
118 91 0052
16,0 cm



118 91 0052
2,0 mm



118 91 0053
5,0 mm



118 91 0054
7,0 mm



118 91 0055
10,0 mm

HÁKY JEMNÉ
DELICATE HOOKS



DESMARRES
13,0 cm



118 38 0020
12 mm

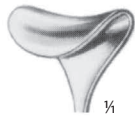

118 91 0077
16 mm



118 38 0010
10 mm



118 38 0030
14 mm



118 91 0078
18 mm

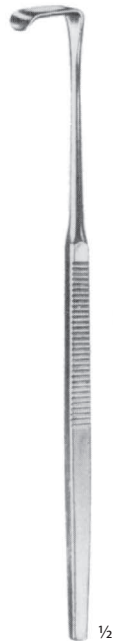

MINI-LANGENBECK
16,0 cm



118 91 0069



118 91 0070



118 91 0071



118 91 0072



CUSHING
20,0 cm



118 91 0085
8 mm



118 91 0087
12 mm



118 91 0089
16 mm



118 91 0086
10 mm



118 91 0088
14 mm



118 91 0090
18 mm



CUSHING
24,0 cm



118 91 0091
8 mm



118 91 0093
12 mm



118 91 0095
16 mm



118 91 0092
10 mm



118 91 0094
14 mm



118 91 0096
18 mm



118 12 0010
16,0 cm

118 12 0010
Fig. 1



118 12 0020
Fig. 2



118 12 0050
16,0 cm

118 12 0050
5,0 mm

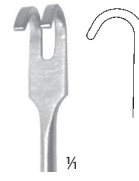

118 12 0060
5,0 mm



118 38 0210
13,5 cm

118 38 0210
2,6 mm



118 38 0220
3,2 mm

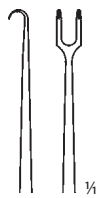

118 38 0230
4,0 mm

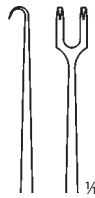

118 38 0360
14,5 cm



HÁKY NA RÁNY
RETRACTORS

MIDDELDORPF
118 08 0650



118 08 0650
14 × 12 mm
22,0 cm



118 08 0660
21 × 21 mm
22,0 cm



118 08 0670
32 × 31 mm
23,5 cm



118 08 0680
62 × 50 mm
28,0 cm



MIDDELDORPF
118 91 0208



118 91 0208
14 × 17 mm
21,5 cm



118 91 0209
20 × 22 mm
22,0 cm



118 91 0210
26 × 30 mm
23,5 cm

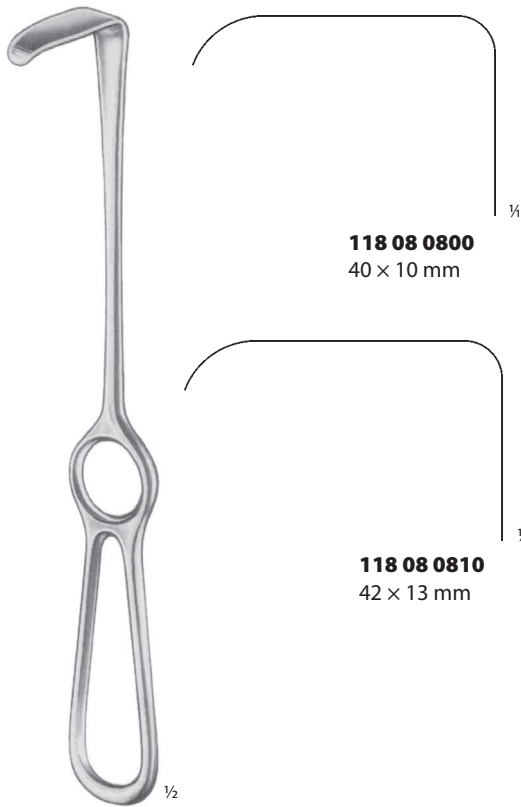

LANGENBECK
21,0 cm

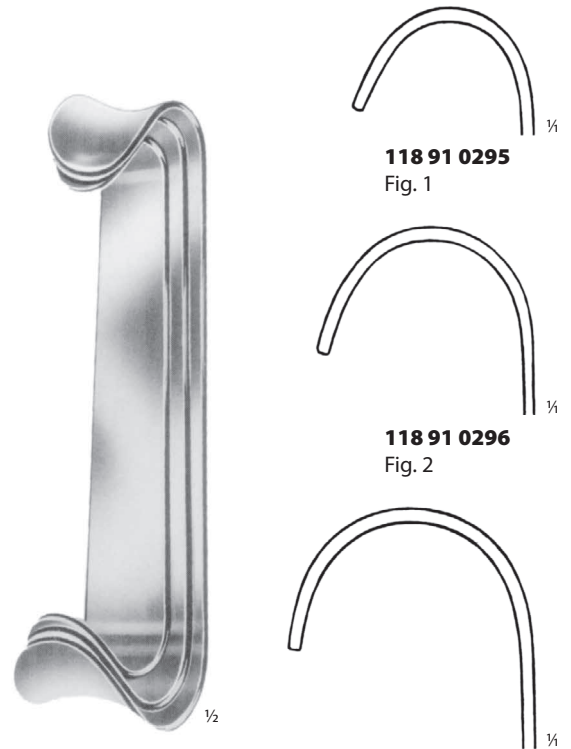

ROUX
118 91 0294
sada (Fig. 1+2+3)
set (Fig. 1+2+3)
16,5 cm

118 91 0297
Fig. 3

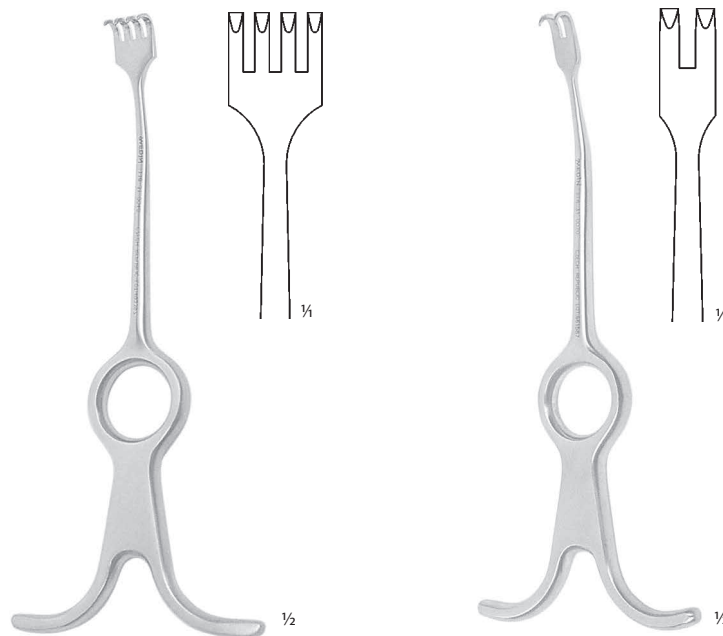

118 31 0040
rovný
straight
16,4 cm

118 31 0070
rovný
straight
16,4 cm

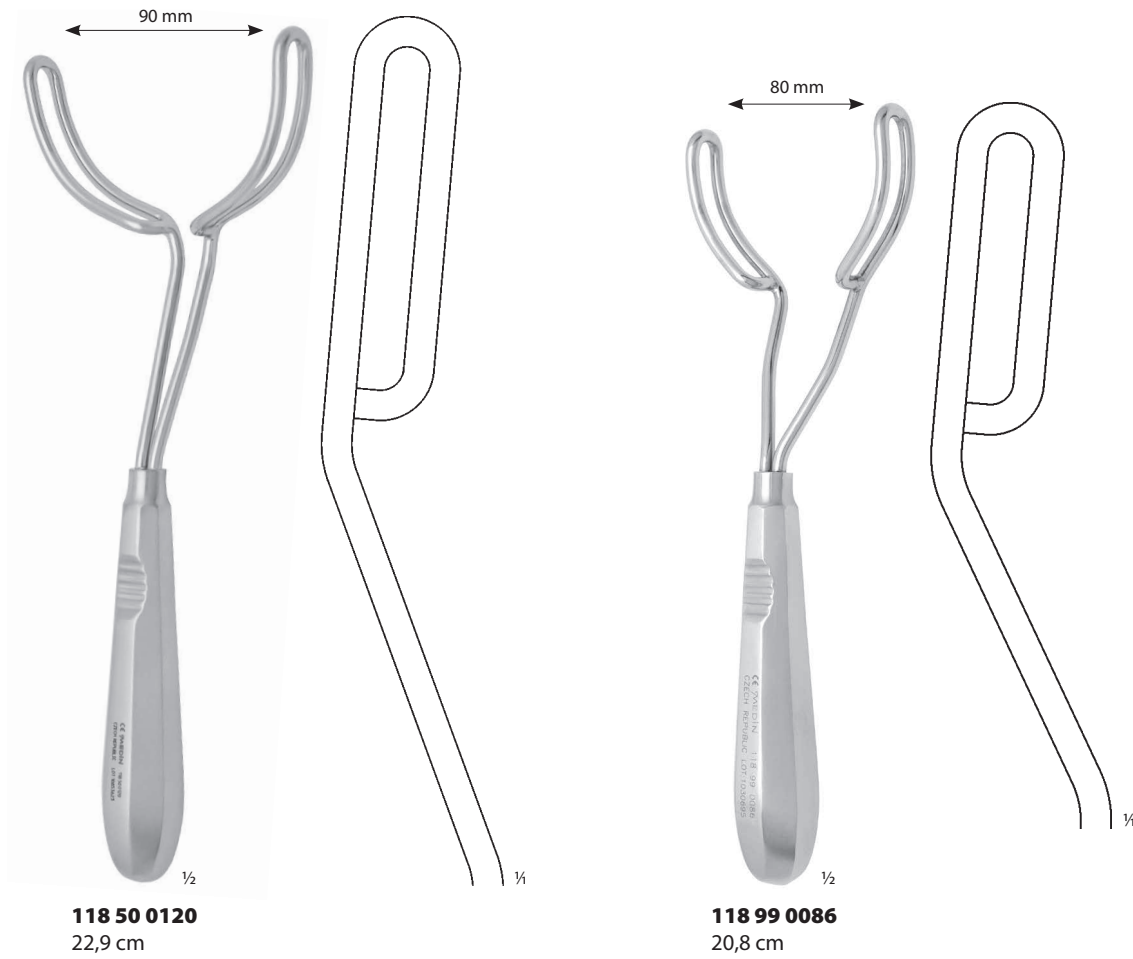
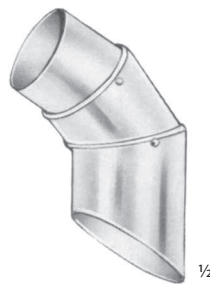
HÁK INTRAORÁLNÍ
INTRAORAL HOOKCHRÁNIČE PRSTU
FINGER PROTECTORS

LANGENBECK

	Ø
136 91 0001	2,20 cm
136 91 0002	2,45 cm
136 91 0003	2,65 cm



ROSER-KÖNIG
119 07 0010
19,5 cm

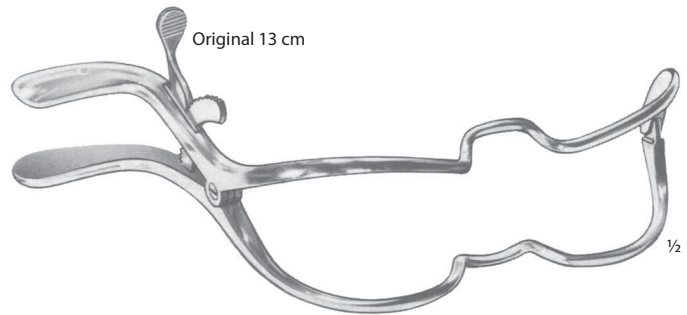

Original 13 cm

JENNINGS

- 119 91 0185** 9,0 cm
- 119 91 0186** 11,0 cm
- 119 91 0187** 13,0 cm
- 119 91 0188** 15,0 cm

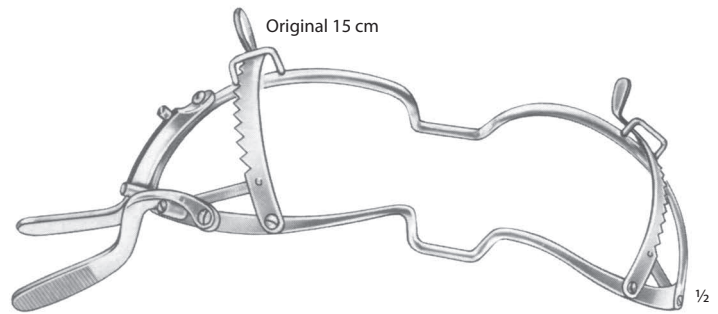

Original 15 cm

WHITEHEAD

- 119 91 0190** 11,0 cm
- 119 91 0191** 13,0 cm
- 119 91 0192** 15,0 cm



HEISTER
119 07 0020
13,0 cm

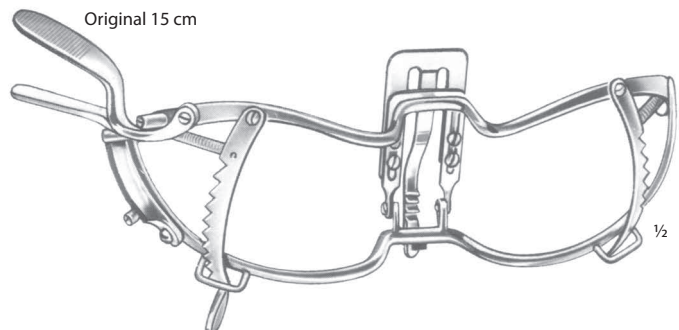

Original 15 cm

WHITEHEAD

- 119 91 0194** 11,0 cm
- 119 91 0195** 13,0 cm
- 119 91 0196** 15,0 cm

LŽIČKY OBOUSTRANNÉ
BONE CURETTES DOUBLE FACED

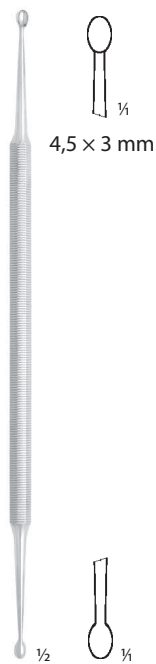

125 50 0010
rovná
straight
17,0 cm

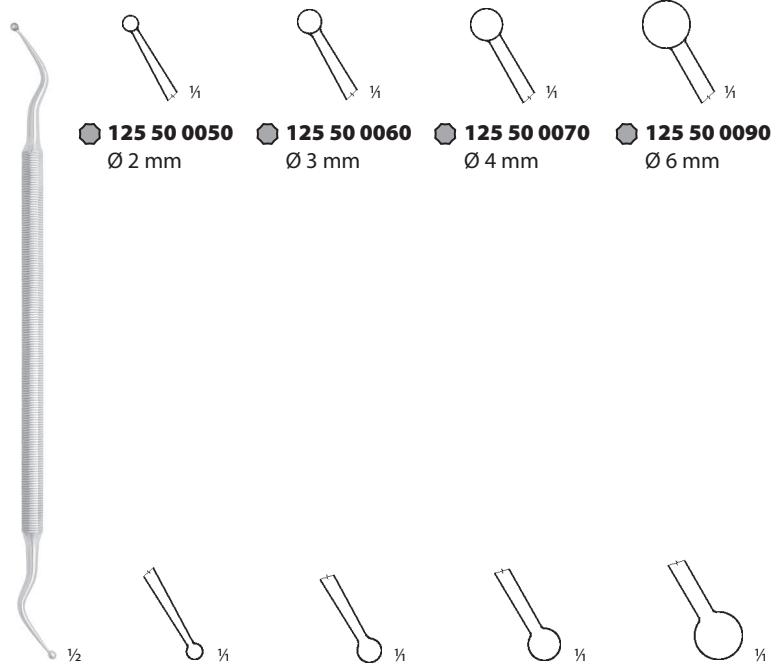

125 50 0050
lomená, ostrá
angled, sharp
17,0 cm



125 56 0066
lomená, ostrá
angled, sharp
16,7 cm

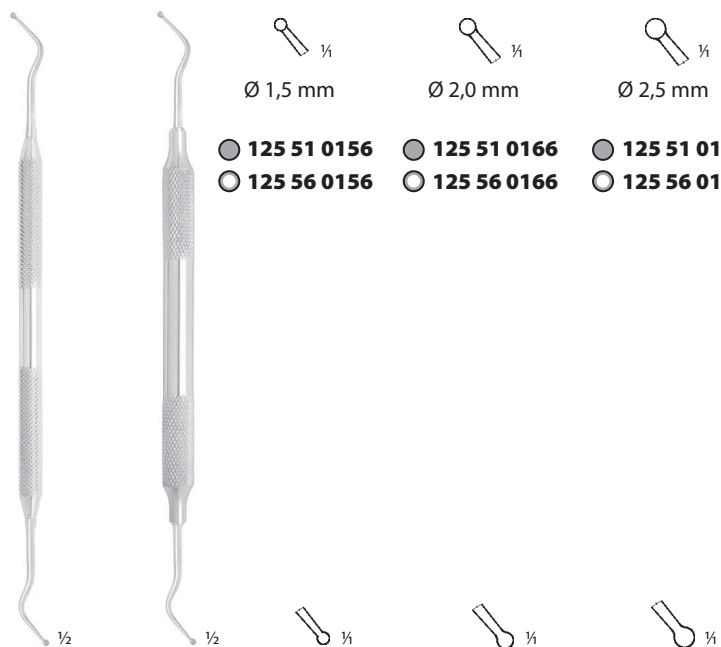

125 51 0156 **125 56 0156**
ostrá ostrá
sharp sharp
16,6 cm 16,6 cm

osmihránné držátko – octagonal handle 5,5 mm
 plné držátko – round solid handle
 duté držátko – hollow handle
 Ø 8,0 mm



Original 17,0 cm



125 08 0110
17,0 cm
Fig. 000
3,5 mm



125 08 0120
17,2 cm
Fig. 0
4,8 mm



125 08 0130
17,5 cm
Fig. 1
6,0 mm



125 08 0140
17,7 cm
Fig. 3
8,5 mm



125 08 0150
18,4 cm
Fig. 5
12,0 mm



Original 17,5 cm



125 08 0160
16,5 cm
Fig. 1
3,0 mm



125 08 0170
16,5 cm
Fig. 2
3,5 mm



125 08 0180
17,5 cm
Fig. 3
4,0 mm



125 08 0190
17,5 cm
Fig. 4
5,0 mm



125 08 0200
19,5 cm
Fig. 5
6,0 mm



125 08 0210
19,5 cm
Fig. 6
6,7 mm

LŽIČKY
BONE CURETTES

125 50 0100
pravá
right
16,3 cm

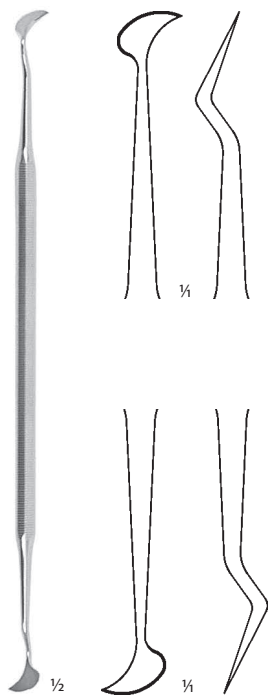

125 50 0110
levá
left
16,3 cm

NOŽE
KNIVES

Nůž na dásněn oboustranný
Gum knife mutual
112 50 0050
18,0 cm

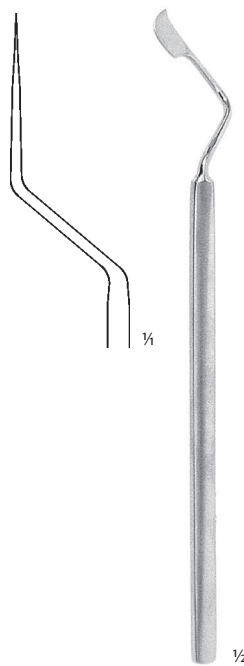

Nůž na gingivektomii
Gingivectomy knife
112 50 0060
17,3 cm
Fig. 1

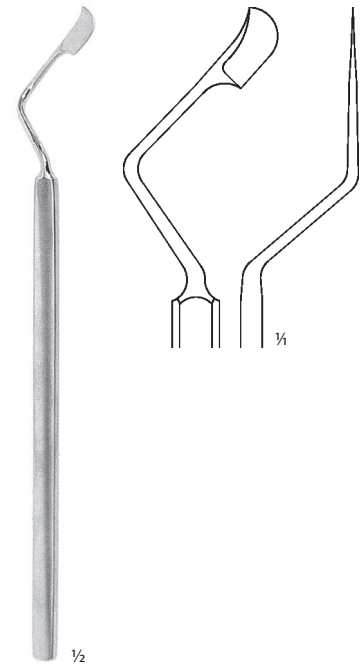

Nůž na gingivektomii
Gingivectomy knife
112 50 0070
17,3 cm
Fig. 2

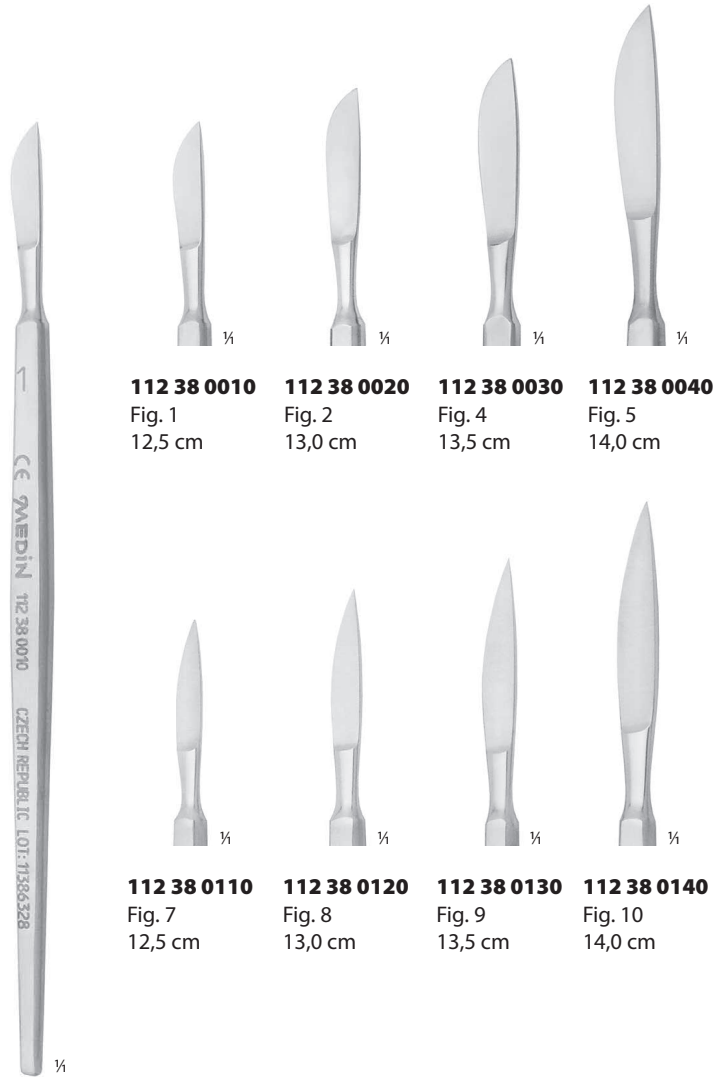

112 38 0010
Fig. 1
12,5 cm

112 38 0020
Fig. 2
13,0 cm

112 38 0030
Fig. 4
13,5 cm

112 38 0040
Fig. 5
14,0 cm

112 38 0110
Fig. 7
12,5 cm

112 38 0120
Fig. 8
13,0 cm

112 38 0130
Fig. 9
13,5 cm

112 38 0140
Fig. 10
14,0 cm

DIEFFENBACH
12,5 cm



112 91 0002
12,3 cm
Fig. 3



112 91 0003
12,3 cm
Fig. 3



112 91 0004
13,3 cm
Fig. 4



112 91 0005
20,5 cm
Fig. 3L

SKALPELOVÉ ČEPELKY STERILNÍ PRO VELIKOST DRŽÁTKA 3
SCALPEL BLADES STERILE FOR HANDLE SIZE 3

pro držátka
for handles

112 91 0002
112 91 0003
112 91 0005
112 91 0007
112 91 0008



112 91 0010
Fig. 10



112 91 0011
Fig. 11



112 91 0012
Fig. 12



112 91 0025
Fig. 12d



112 91 0013
Fig. 13



112 91 0015
Fig. 15



112 91 0026
Fig. 15c

POZNÁMKY: sterilní, balení 100 ks
NOTES: sterile, packing 100 pcs

SKALPELOVÉ ČEPELKY STERILNÍ PRO VELIKOST DRŽÁTKA 4
SCALPEL BLADES STERILE FOR HANDLE SIZE 4

pro držátka
for handles

112 91 0004
112 91 0006
112 08 0650



112 91 0018
Fig. 18



112 91 0020
Fig. 20



112 91 0021
Fig. 21



112 91 0022
Fig. 22



112 91 0023
Fig. 23



112 91 0024
Fig. 24



112 91 0027
Fig. 25

POZNÁMKY: sterilní, balení 100 ks
NOTES: sterile, packing 100 pcs

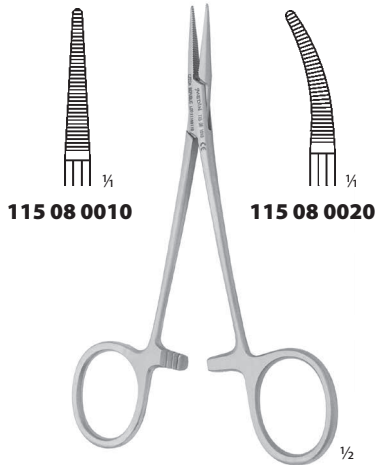
SVORKY NA CÉVY
ARTERY FORCEPS

MOSQUITO-HALSTED
standard
standard
12,0 cm

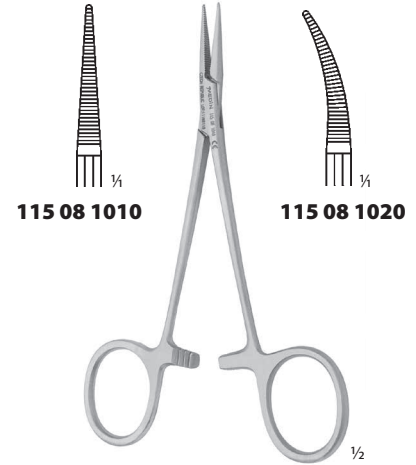

MOSQUITO-HALSTED
jemné
fine
12,0 cm

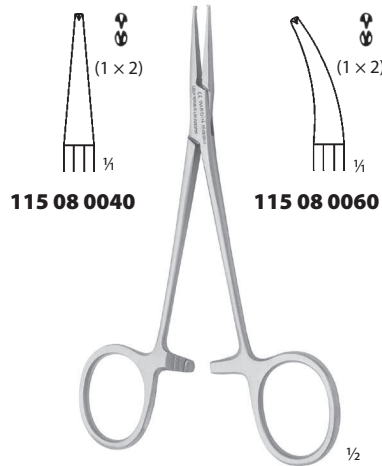

MOSQUITO-HALSTED
hladká čelist
smooth jaw
12,0 cm

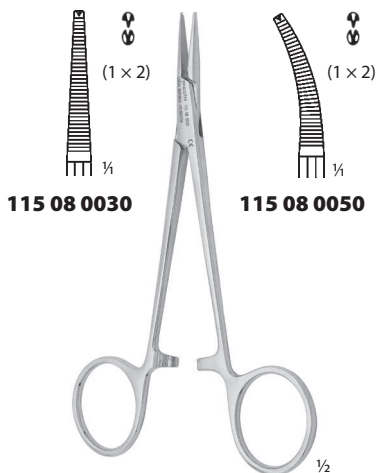

MOSQUITO-HALSTEAD
standard
standard
12,0 cm

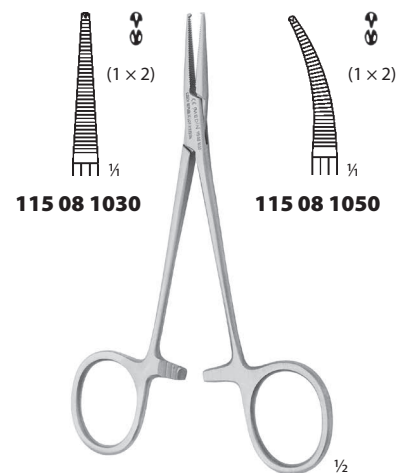

MOSQUITO-HALSTEAD
jemné
fine
12,0 cm

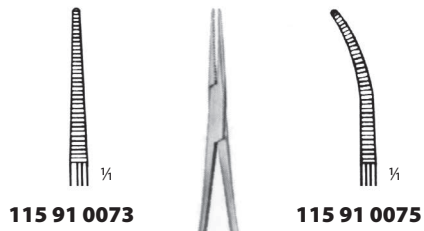

MICRO-MOSQUITO
12,0 cm

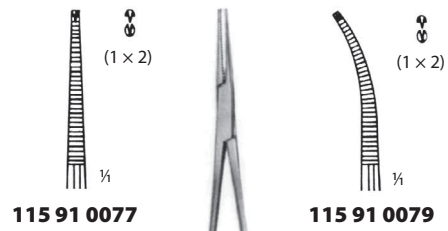

MICRO-MOSQUITO
12,0 cm

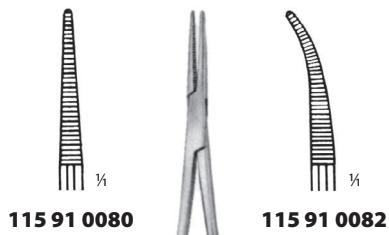

HALSTEAD-MOSQUITO
12,5 cm

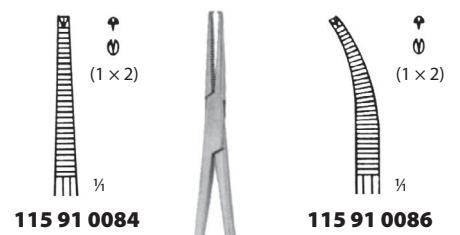

HALSTEAD-MOSQUITO
12,5 cm

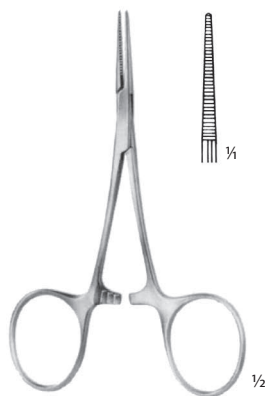

HARTMANN
115 91 0068
10,0 cm

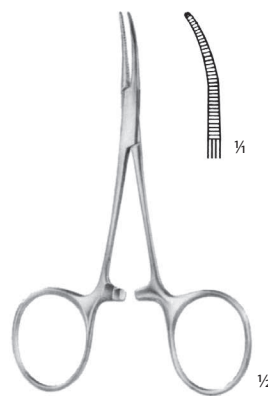

HARTMANN
115 91 0069
10,0 cm

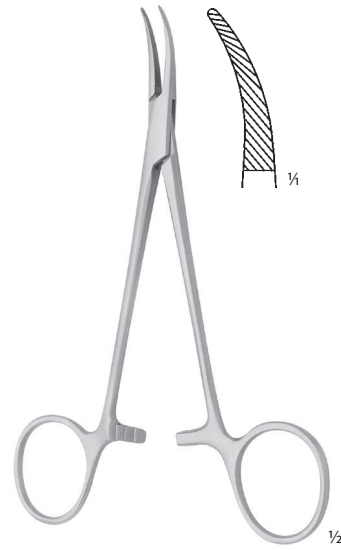
SVORKY NA CÉVY
ARTERY FORCEPS**ROCHESTER-PEAN**
115 08 0260zahnutá
curved
14,0 cm**KELLY**
115 08 0500zahnutá
curved
14,0 cmSVORKA CHIRURGICKÁ
TISSUE FORCEPS**BABCOCK**
115 91 0382

16,0 cm



DE BAKEY

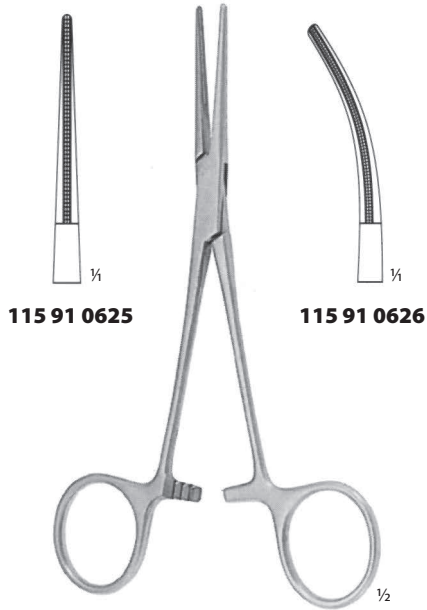

DE BAKEY-RANKIN
16,0 cm

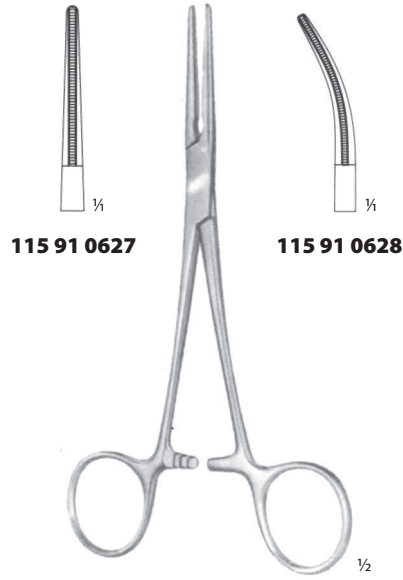

DE BAKEY-MOSQUITO
15,0 cm



DE BAKEY-MOSQUITO
12,0 cm



DE BAKEY-PEAN

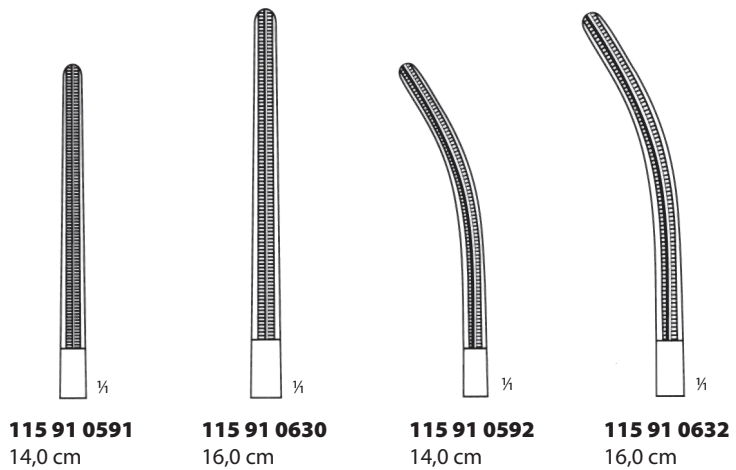



BACKHAUS
115 08 0780
11,8 cm



BACKHAUS
115 08 0790
12,0 cm



BACKHAUS-CLIP
115 91 0341
11,0 cm



BACKHAUS
115 91 0343 11,0 cm
115 91 0345 15,0 cm

Original 15,0 cm



BACKHAUS
115 08 0810 8,0 cm
115 08 0820 13,0 cm

Original 13,0 cm



ROEDER
115 91 0348 13,0 cm
115 91 0349 15,0 cm

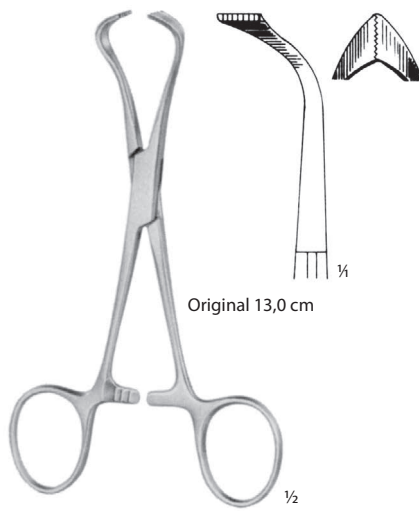

LORNA
115 91 0350 10,0 cm
115 91 0351 13,0 cm

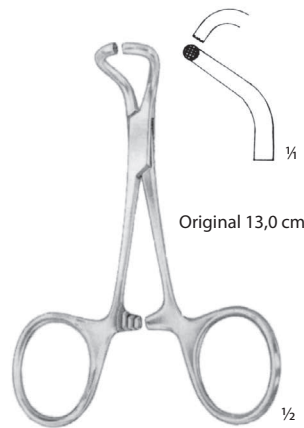

TOHOKU-JAPAN
115 91 0352 10,0 cm
115 91 0353 13,0 cm

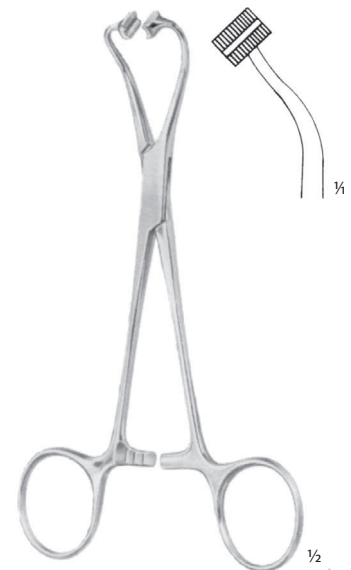

PEERS
115 91 0354
 14,5 cm

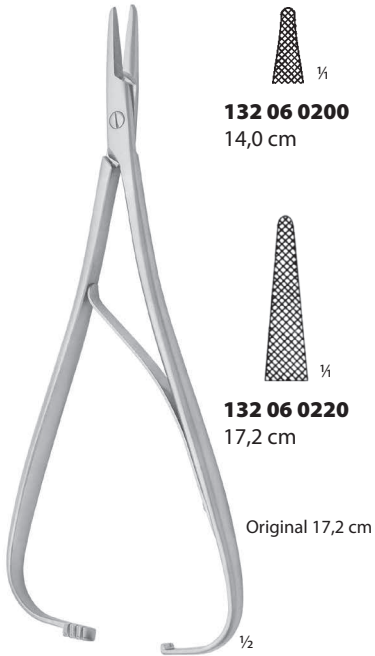

MATHIEU

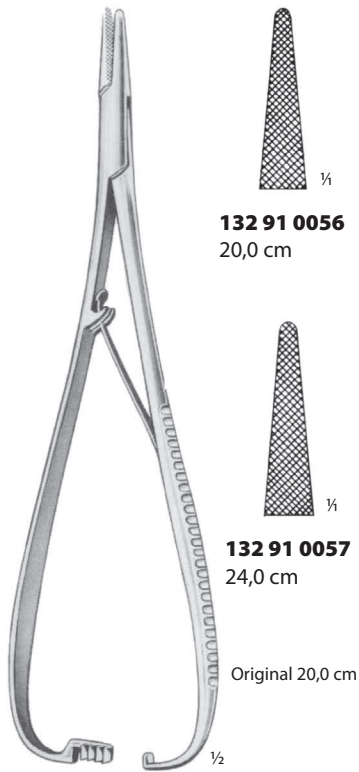
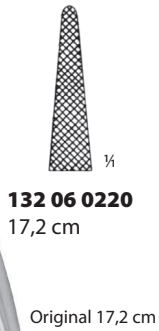

MATHIEU

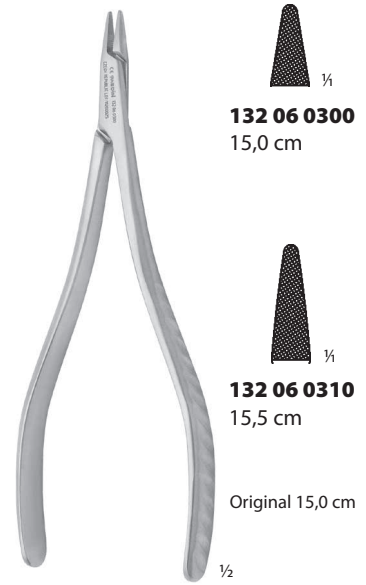
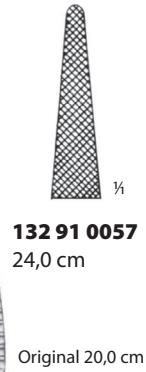

CRILE



132 06 0810
20,5 cm



132 06 0341
16,5 cm



BOYNTON
132 38 0120
12,5 cm



Original 19,0 cm

OLSEN-HEGAR

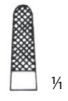

132 91 0160
14,0 cm

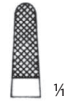

132 91 0161
17,0 cm



132 91 0162
19,0 cm



132 06 0610
16,5 cm



Original 25,5 cm

RYDER/FRENCH-EYE
132 06 0650
25,5 cm



132 06 0600
16,5 cm



132 06 0640
20,5 cm



132 06 0650
25,5 cm

JEHELCE TVRDOKOVOVÉ
NEEDLE HOLDERS WITH TUNGSTEN CARBIDE INSERT



MATHIEU
132 06 0520
14,0 cm



MATHIEU
132 06 0500
17,2 cm



MATHIEU
132 06 0510
21,5 cm



132 91 0168
17,0 cm



132 91 0169
20,0 cm



132 91 0170
23,0 cm



BOYNTON
132 91 0182
12,0 cm



CRILE
132 06 0370
15,7 cm



CRILE
132 06 0450
16,2 cm

JEHELCE TVRDOKOVOVÉ
NEEDLE HOLDERS WITH TUNGSTEN CARBIDE INSERT

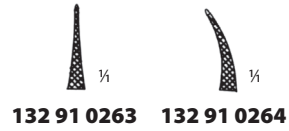
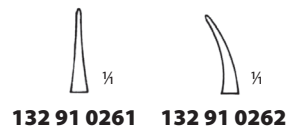

CASTROVIEJO
14,0 cm

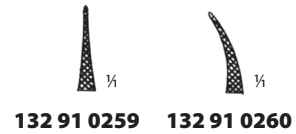

CASTROVIEJO
14,0 cm

MIKRO JEHELCE TVRDOKOVOVÉ
MICRO-NEEDLE HOLDERS WITH TUNGSTEN CARBIDE INSERT

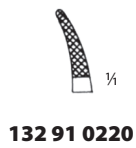
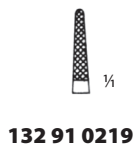

CASTROVIEJO
18,0 cm

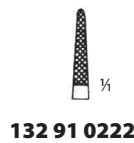
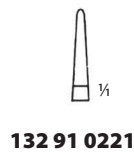
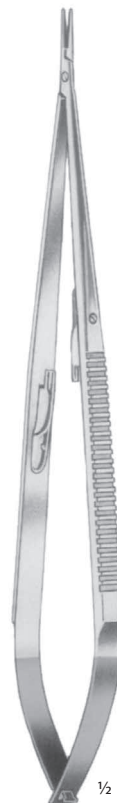

JACOBSON
21,0 cm

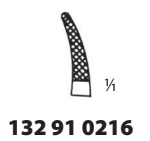
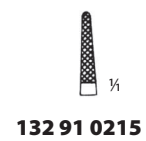

CASTROVIEJO
14,0 cm

ZAVADĚČE DRENŮ
DRAIN INTRODUCERS

LUNIATSCHEK
132 50 0180
17,0 cm



LUNIATSCHEK
132 50 0186
16,8 cm



LUNIATSCHEK
132 56 0186
16,8 cm



LUNIATSCHEK
132 50 0196
žlábkový
grooved
16,8 cm



LUNIATSCHEK
132 56 0196
žlábkový
grooved
16,8 cm

○ osmihránné držátko – octagonal handle

5,5 mm

○ plné držátko – round solid handle

Ø 6,0 mm

○ duté držátko – hollow handle

Ø 8,0 mm

DLAHA PREFABRIKOVANÁ
PREFABRICATED PLATE

129 51 0100
15,2 cm



LISTER
113 05 0030
15,0 cm



LISTER
113 05 0040
20,0 cm

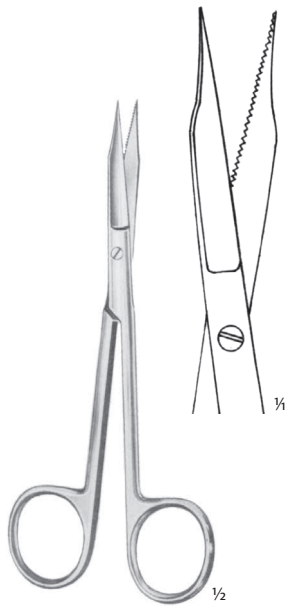

GOLDMANN-FOX
113 91 0474
se zuby, rovné
saw edge, straight
13,0 cm

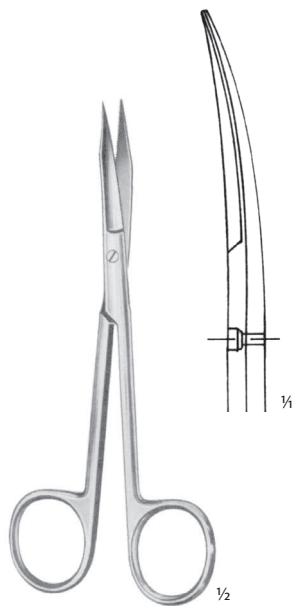

GOLDMANN-FOX
113 91 0475
se zuby, zahnuté
saw edge, curved
13,0 cm



QUINBY
113 91 0483
rovné
straight
12,0 cm

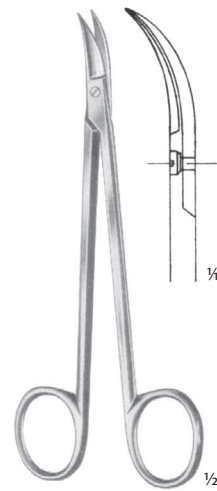

QUINBY
113 91 0484
zahnuté
curved
12,0 cm

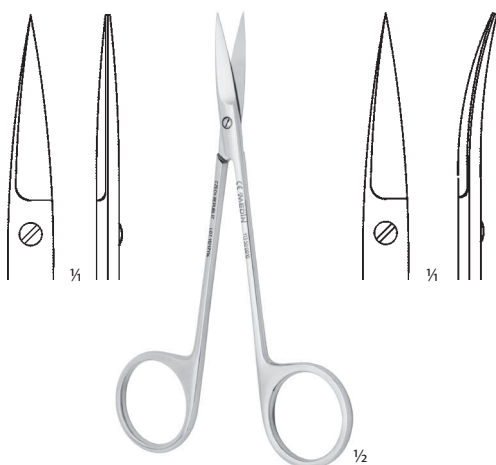

113 50 0010
rovné
straight
12,0 cm

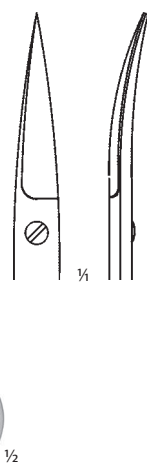

113 50 0020
zahnuté
curved
12,0 cm



113 50 0030
rovné
straight
14,5 cm

113 50 0040
zahnuté
curved
14,5 cm



SANVENERO
113 91 0221
rovné
straight
14,0 cm

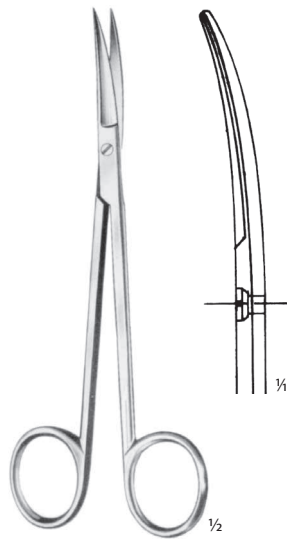

SANVENERO
113 91 0222
zahnuté
curved
14,0 cm



REYNOLDS
113 91 0233
rovné
straight
15,0 cm

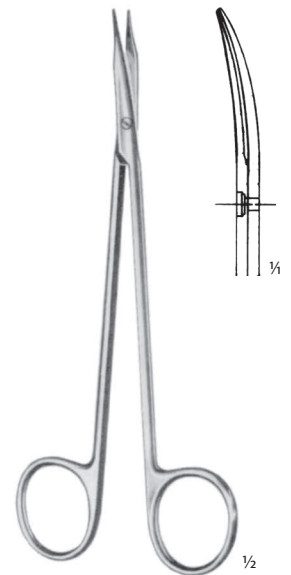

REYNOLDS
113 91 0235
zahnuté
curved
15,0 cm

NŮŽKY PRO LIGATURU
LIGATURE SCISSORS



SPENCER
113 91 0399 113 91 0400
9,0 cm 10,5 cm



LITTAUER
113 91 0403
14,0 cm

NŮŽKY CHIRURGICKÉ
OPERATING SCISSORS

Original 15 cm

STANDARD
hrotnaté rovné
sharp straight

113 08 0010 13,0 cm
113 08 0020 15,0 cm
113 08 0040 18,5 cm
113 08 0060 22,0 cm
113 08 0070 30,0 cm

½



Original 15 cm

STANDARD
hrotnaté zahnuté
sharp curved

113 08 0310 13,0 cm
113 08 0320 15,0 cm
113 08 0340 18,5 cm
113 08 0360 22,0 cm
113 08 0370 30,0 cm

½



Original 15 cm

STANDARD
hrotnatotupé rovné
sharp-blunt straight

113 08 0110 13,0 cm
113 08 0120 15,0 cm
113 08 0140 18,5 cm
113 08 0160 22,0 cm
113 08 0170 30,0 cm

½



Original 15 cm

STANDARD
hrotnatotupé zahnuté
sharp-blunt curved

113 08 0410 13,0 cm
113 08 0420 15,0 cm
113 08 0440 18,5 cm
113 08 0460 22,0 cm
113 08 0470 30,0 cm

½



Original 15 cm

STANDARD
tupé rovné
blunt straight

113 08 0210 13,0 cm
113 08 0220 15,0 cm
113 08 0240 18,5 cm
113 08 0260 22,0 cm
113 08 0270 30,0 cm

½



Original 15 cm

STANDARD
tupé zahnuté
blunt curved

113 08 0510 13,0 cm
113 08 0520 15,0 cm
113 08 0540 18,5 cm
113 08 0560 22,0 cm
113 08 0570 30,0 cm

½



Original 16,5 cm

STANDARD
hrotnaté rovné
sharp straight

113 91 0042 11,5 cm
113 91 0046 16,5 cm
113 91 0049 20,0 cm



Original 16,5 cm

STANDARD
hrotnaté zahnuté
sharp curved

113 91 0051 11,5 cm
113 91 0055 16,5 cm
113 91 0058 20,0 cm



Original 16,5 cm

STANDARD
hrotnatotupé rovné
sharp-blunt straight

113 91 0020 11,5 cm
113 91 0026 16,5 cm
113 91 0029 20,0 cm



Original 16,5 cm

STANDARD
hrotnatotupé zahnuté
sharp-blunt curved

113 91 0031 11,5 cm
113 91 0037 16,5 cm
113 91 0040 20,0 cm



Original 16,5 cm

STANDARD
tupé rovné
blunt straight

113 91 0002 11,5 cm
113 91 0006 16,5 cm
113 91 0009 20,0 cm



Original 16,5 cm

STANDARD
tupé zahnuté
blunt curved

113 91 0011 11,5 cm
113 91 0015 16,5 cm
113 91 0018 20,0 cm



WAGNER
113 91 0328
jemné rovné
fine straight
12,0 cm

WAGNER
113 91 0331
jemné zahnuté
fine curved
12,0 cm

WALTON
113 91 0348
10,0 cm

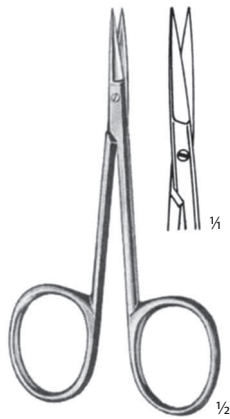

MOD. BONN
113 91 0349
extra jemné
extra delicate
8,0 cm

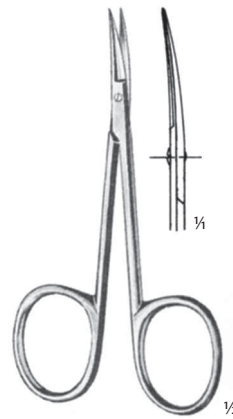

MOD. BONN
113 91 0350
extra jemné
extra delicate
8,0 cm



113 38 0010
113 38 0071
hrotnaté rovné
sharp straight



113 38 0040
113 38 0091
hrotnaté zahnuté
sharp curved



113 38 0020
113 38 0150
hrotnatotupé rovné
sharp-blunt straight



113 38 0050
113 38 0100
hrotnatotupé zahnuté
sharp-blunt curved



113 38 0030
113 38 0081
tupé rovné
blunt straight



113 38 0060
113 38 0161
tupé zahnuté
blunt curved



113 38 0210
hrotnaté
sharp
10,5 cm

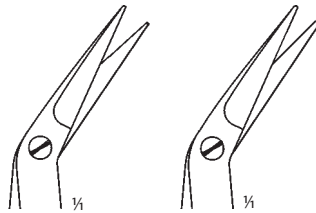

113 38 0260
tupé
blunt
10,5 cm



113 38 0311
11,5 cm



NOYES
12,0 cm



113 91 0490



113 91 0492



113 91 0494

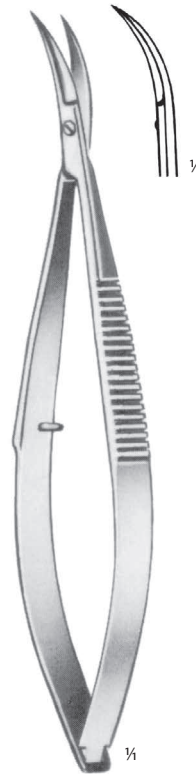

CASTROVIEJO
113 91 0507
10,0 cm

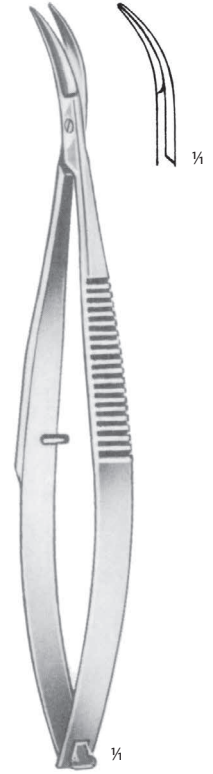

CASTROVIEJO
113 91 0508
10,0 cm

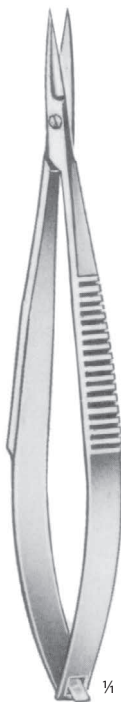

CASTROVIEJO
113 91 0502
9,0 cm



113 91 0503

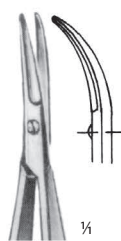

113 38 1020



113 91 0505



113 38 1030



113 91 0537

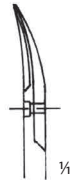

113 91 0539



GOMEL
14,5 cm



113 91 0538

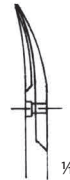

113 91 0540



GOMEL
18,0 cm



113 91 0552



113 91 0553



18,5 cm

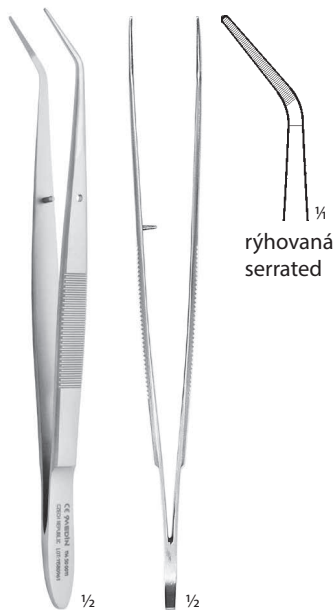

114 50 0011
zahnutá
curved
15,7 cm



114 50 0021
lomená
angled
15,7 cm



114 50 0031
lomená
angled
15,7 cm



114 50 1030
lomená
angled
15,7 cm



114 50 0051
15,7 cm



114 50 0150
zahnutá, jemná
curved, fine
14,2 cm



114 50 0170
zahnutá
curved
15,7 cm



114 08 0090
14,5 cm



114 08 0101
jemná
fine
14,5 cm



114 08 0231
velmi jemná
very fine
14,5 cm



114 08 0140
jemná
fine
20,0 cm



114 08 0240
velmi jemná
very fine
20,0 cm



114 08 0250
24,5 cm

PINZETY ANATOMICKÉ
DRESSING FORCEPS

Original 14,5 cm

114 91 0002 **114 91 0003** **114 91 0004** **114 08 0030** **114 91 0006** **114 08 0040** **114 08 0050** **114 08 0060**

114 91 0002	11,5 cm
114 91 0003	13,0 cm
114 91 0004	14,5 cm
114 08 0030	16,0 cm
114 91 0006	18,0 cm
114 08 0040	20,0 cm
114 08 0050	25,0 cm
114 08 0060	30,0 cm

STANDARD 1/2

PINZETY CHIRURGICKÉ
TISSUE FORCEPS

Original 14,5 cm

114 91 0011 **114 91 0012** **114 08 0381** **114 91 0015** **114 08 0340** **114 08 0350** **114 08 0360**

114 91 0011	11,5 cm
114 91 0012	13,0 cm
114 08 0381	14,5 cm
114 91 0015	18,0 cm
114 08 0340	20,0 cm
114 08 0350	25,0 cm
114 08 0360	30,0 cm

STANDARD 1/2



114 08 0430
jemná
fine
16,0 cm



114 08 0530
velmi jemná
very fine
14,5 cm

PINZETY ŠÍČÍ
SUTURING FORCEPS



Original 12,0 cm

114 91 0255
12,0 cm

114 91 0257
12,0 cm

114 91 0256
15,0 cm

114 91 0258
15,0 cm

PINZETY TVRDOKOVOVÉ
FORCEPS WITH TUNGSTEN CARBIDE INSERT

OEHLER

(1 × 2)

114 91 0477 14,0 cm

114 91 0478 16,0 cm

114 91 0479 18,0 cm

Original 18,0 cm

114 91 0480 20,0 cm

114 91 0481 25,0 cm

114 91 0482 30,0 cm

1/2

ADSON

Original 12,0 cm

(1 × 2)

114 91 0487 12,0 cm

114 91 0490 12,0 cm

114 91 0489 15,0 cm

114 91 0491 15,0 cm

1/2

SEMKEN

Original 12,5 cm

114 91 0483 12,5 cm

114 91 0484 15,5 cm

1/2

GILLIES

(2 × 1)

114 91 0485 15,0 cm

1/2

JEWELER

114 91 0486 15,0 cm

1/2

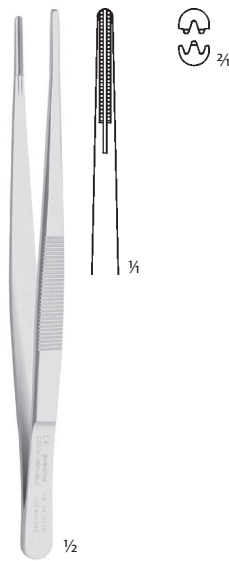

114 14 0100
14,5 cm

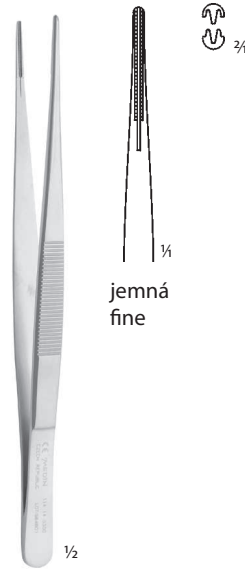

114 14 0300
14,5 cm

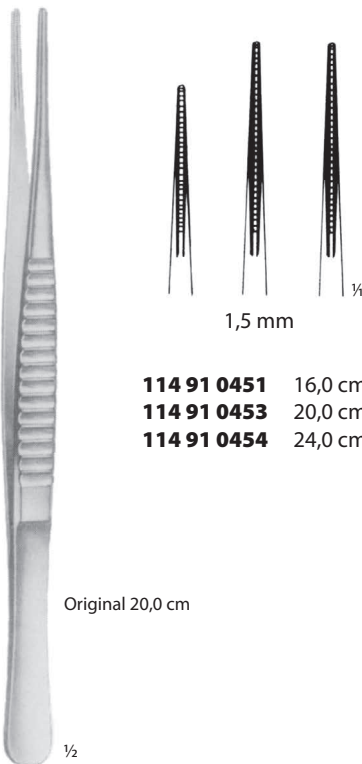

114 91 0451 16,0 cm
114 91 0453 20,0 cm
114 91 0454 24,0 cm

DE BAKEY

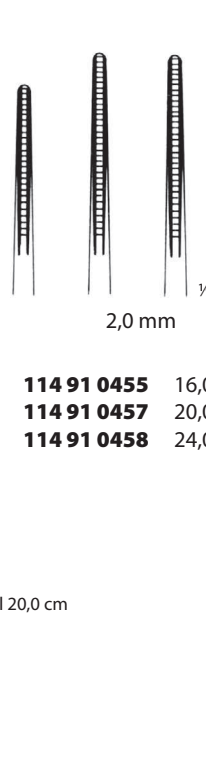

114 91 0455 16,0 cm
114 91 0457 20,0 cm
114 91 0458 24,0 cm

DE BAKEY

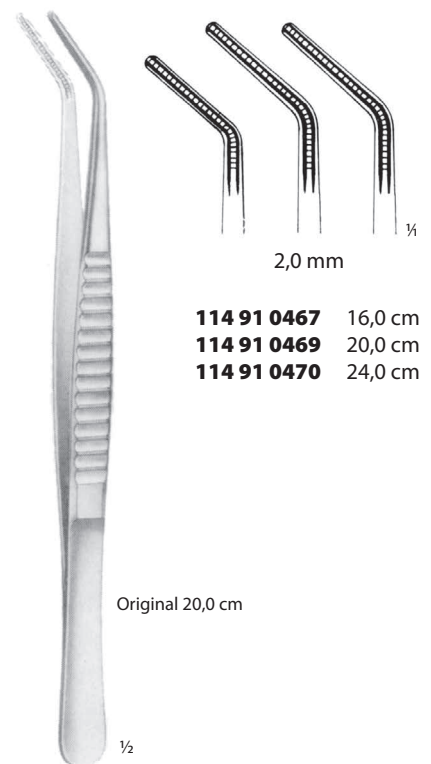

114 91 0467 16,0 cm
114 91 0469 20,0 cm
114 91 0470 24,0 cm

DE BAKEY



GRAEFE
10,5 cm

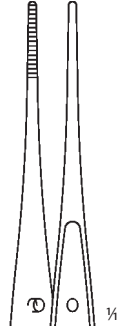

114 38 0010

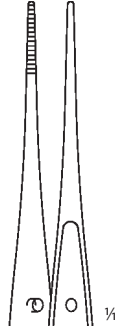

114 38 0020
jemná
fine

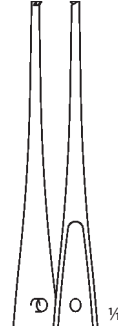

114 38 0150

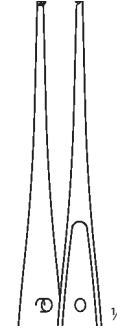

114 38 0160
jemná
fine

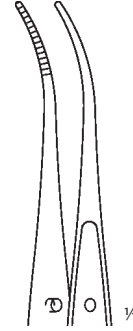

114 38 0100
jemná
fine



se zámkem
with lock

GRAEFE
114 38 0360
11,0 cm

B

DIAGNOSTIKA
DIAGNOSTICS



Sondy, pátridla	Probes	73
Lopatky	Spatulas	74
Zrcátka	Mirrors	74–75
Stomatologické soubory	Stomatological Sets	76

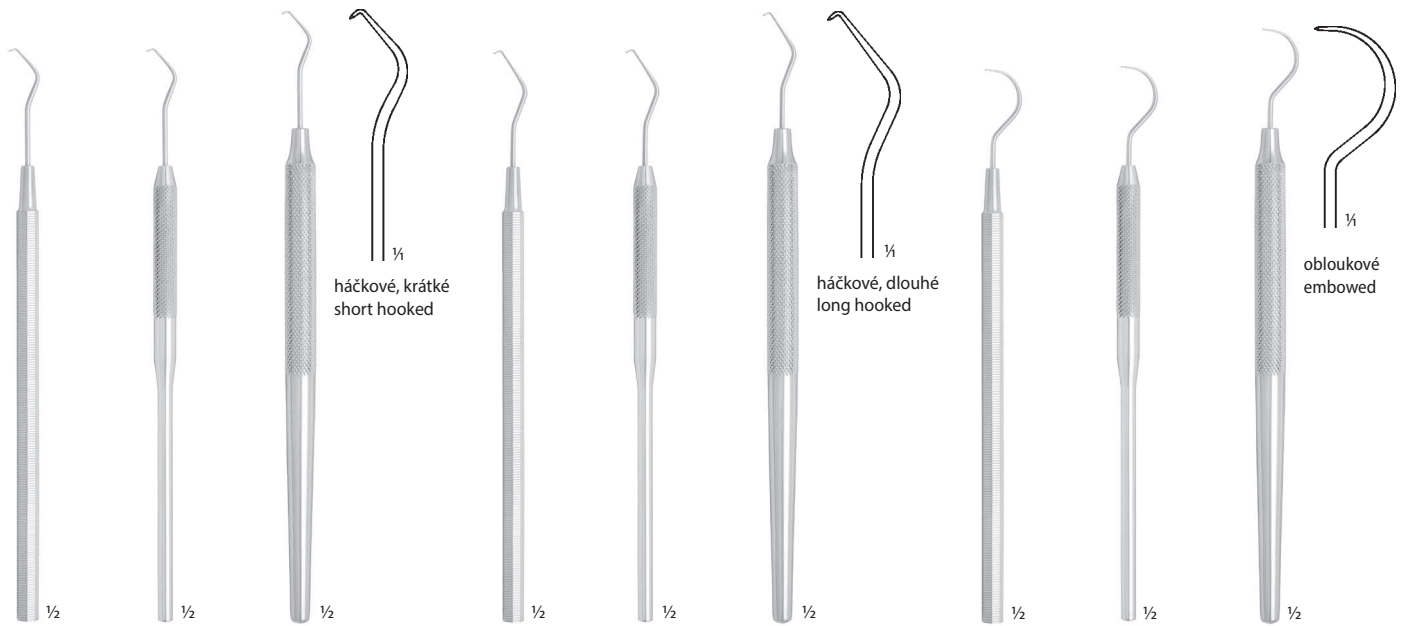

133 51 0010 15,2 cm	133 51 0016 15,2 cm	133 56 0016 16,3 cm	133 51 0020 15,1 cm	133 51 0026 15,1 cm	133 56 0026 16,2 cm	133 51 0030 14,5 cm	133 51 0036 14,5 cm	133 56 0036 15,6 cm
-------------------------------	-------------------------------	-------------------------------	-------------------------------	-------------------------------	-------------------------------	-------------------------------	-------------------------------	-------------------------------

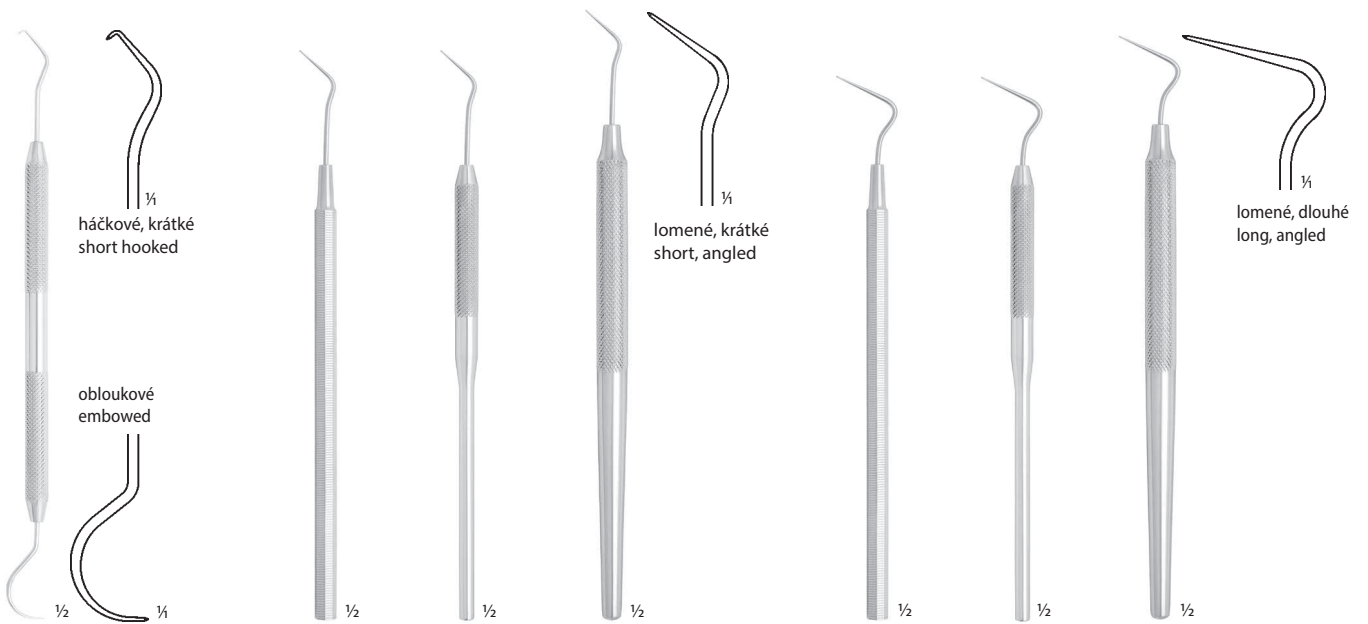

133 99 0186 15,7 cm	133 51 0040 15,0 cm	133 51 0046 15,0 cm	133 56 0046 16,1 cm	133 51 0050 14,0 cm	133 51 0056 14,0 cm	133 56 0056 15,1 cm
-------------------------------	-------------------------------	-------------------------------	-------------------------------	-------------------------------	-------------------------------	-------------------------------



BOWMANN
133 38 0060 Ø 0,5 mm 13,0 cm
133 38 0070 Ø 0,7 mm 13,0 cm
133 38 0080 Ø 0,9 mm 13,0 cm

LOPATKY
SPATULAS

BUCHWALD
121 31 0010
 17,3 cm
 16/23 mm



BRÜNNINGS
121 31 0020
 19,5 cm
 14/18 mm

ZRCÁTKA INTRAORÁLNÍ
INTRAORAL MIRRORS

HR FRONT
BUCCAL
122 91 0420
 přední vrstva se zvýšenou odrazivostí,
 jednostranné, síla 3 mm, šířka 4 cm
 high reflection front coating
 one-side coated, thickness 3 mm, bridth 4 cm
 16,0 cm



HR FRONT
OCCUSAL
122 91 0421
 přední vrstva se zvýšenou odrazivostí,
 jednostranné, síla 3 mm, šířka 6,5/4 cm
 high reflection front coating
 one-side coated, thickness 3 mm, bridth 6,5/4 cm
 15,0 cm



HR FRONT
LINGUAL
122 91 0422
 přední vrstva se zvýšenou odrazivostí,
 oboustranné, síla 2 mm
 high reflection front coating
 double-side coated, thickness 2 mm
 16,0 cm





122 51 0010
 1 : 1
 ploché
 plane
 Ø 24 mm



122 51 0020
 2,25×
 zvětšovací
 magnifying
 Ø 24 mm



HR FRONT
 přední vrstva se zvýšenou odrazivostí
 high reflection front coating
122 91 0411 1 : 1 Fig. 8 Ø 30 mm
122 91 0333 1 : 1 Fig. 5 Ø 24 mm
122 91 0407 1 : 1 Fig. 4 Ø 22 mm
122 91 0408 1 : 1 Fig. 0 Ø 14 mm



přední vrstva
 front surface

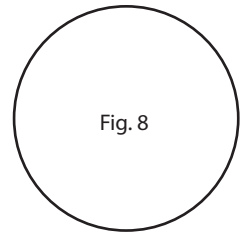

Fig. 8

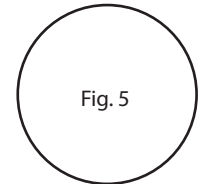

Fig. 5

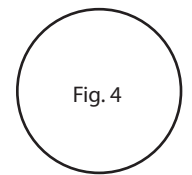

Fig. 4

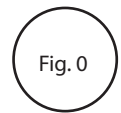

Fig. 0

POZNÁMKY: balení 12 ks
 NOTES: packing 12 pcs

DRŽÁTKA ZUBNÍCH ZRCÁTEK
DENTAL MIRROR HANDLES

● **122 51 0100**
 osmihranné držátko 5,5 mm
 octagonal handle 5,5 mm
 12,0 cm



● **122 51 0106**
 plné držátko Ø 6,0 mm
 round solid handle Ø 6,0 mm
 12,0 cm



○ **122 56 0106**
 duté držátko Ø 8,0 mm
 hollow handle Ø 8,0 mm
 13,0 cm

SOUBOR STOMATOLOGICKÝ VYŠETŘOVACÍ
EXAMINATION STOMATOLOGICAL SET**139 50 0120**

soubor

set

22,0 × 10,5 × 3,6 cm

114 50 0011	Pinzeta zubní zahnutá, rýhovaná
122 51 0020	Zrcátko zubní zvětšovací
122 51 0100	Držátko zubního zrcátka
133 51 0050	Pátradlo zubní lomené, dlouhé
139 50 0150	Držák (aluminium)
139 50 0170	Kazeta (aluminium)
147 51 0040	Srpek na zubní kámen
148 51 0110	Exkavátor, oboustranný

Tweezer – curved, serrated
Dental mirror – magnifying
Dental handle
Dental probe – long, angled
Holder (aluminium)
Cassette (aluminium)
Scaler
Excavator, double-faced

počet ks
number of pcs1
1
1
1
1
1
1
1



ZÁCHOVNÁ STOMATOLOGIE

RESTORATIVE



Exkavátory	Excavators	79–80
Nástroje pro výplně	Filling Instruments	81–94
Lopatky	Spatulas	95
Matrice	Matrixes	96–97
Nástroje na snímání korunek	Crown Removers	98

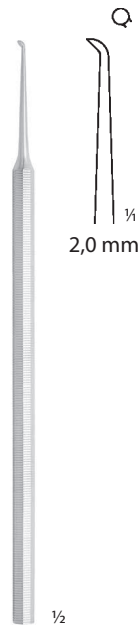

148 51 0010
rovný
straight
15,5 cm

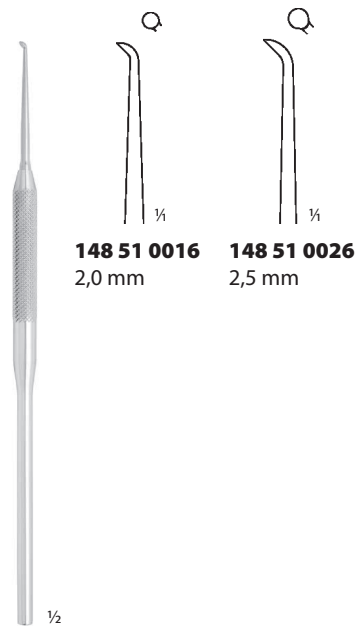

148 51 0016
rovný
straight
15,5 cm



148 51 0056
pravý
right
15,5 cm



148 51 0076
levý
left
15,5 cm



148 51 0100
1,5 mm



148 51 0110
2,0 mm



148 51 0120
2,5 mm



148 51 0100
oboustranný
double faced
17,0 cm



148 51 0096
0,8 mm



148 51 0136
1,0 mm



148 51 0106
1,5 mm



148 51 0116
2,0 mm



148 51 0126
2,5 mm

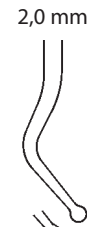

148 51 0106
oboustranný
double faced
16,8 cm

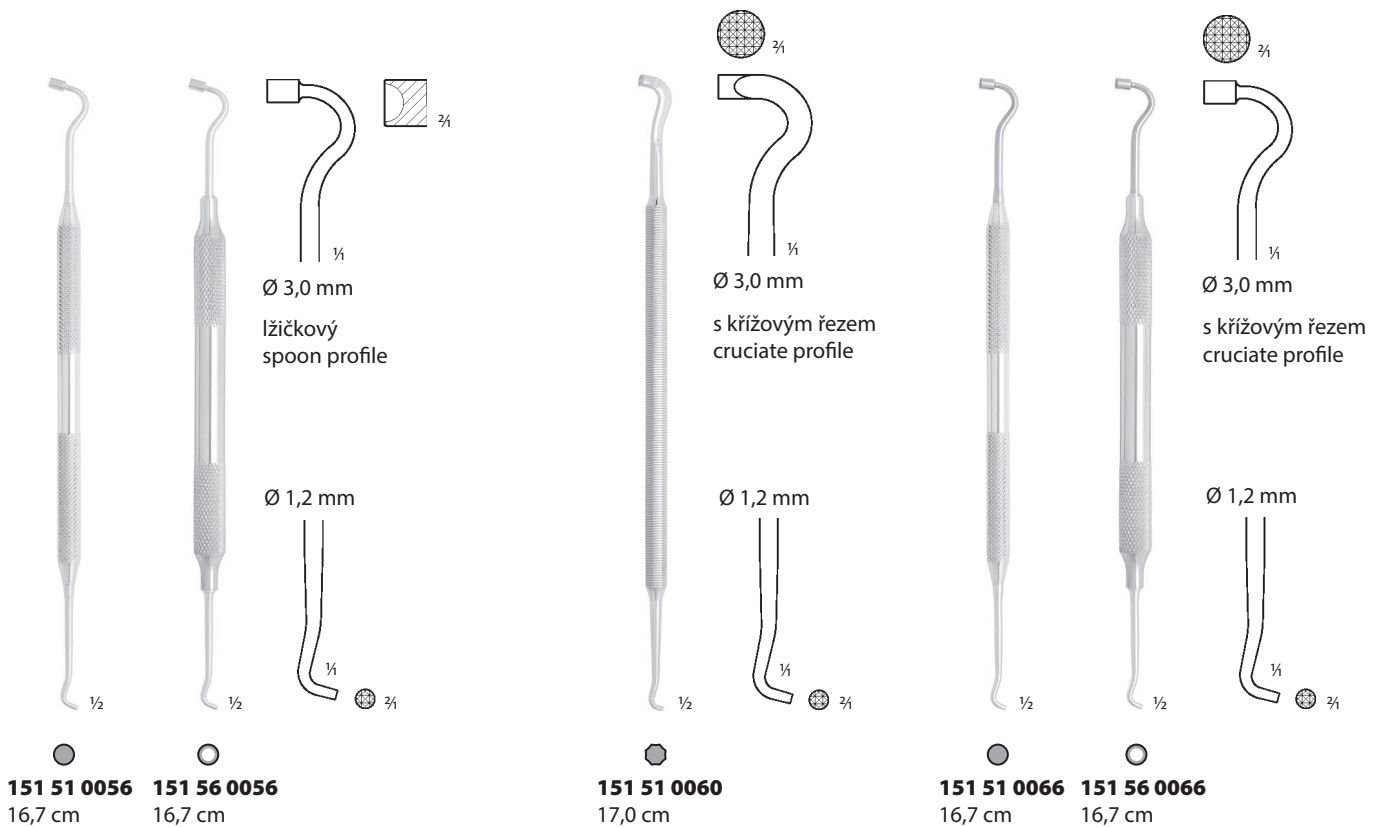
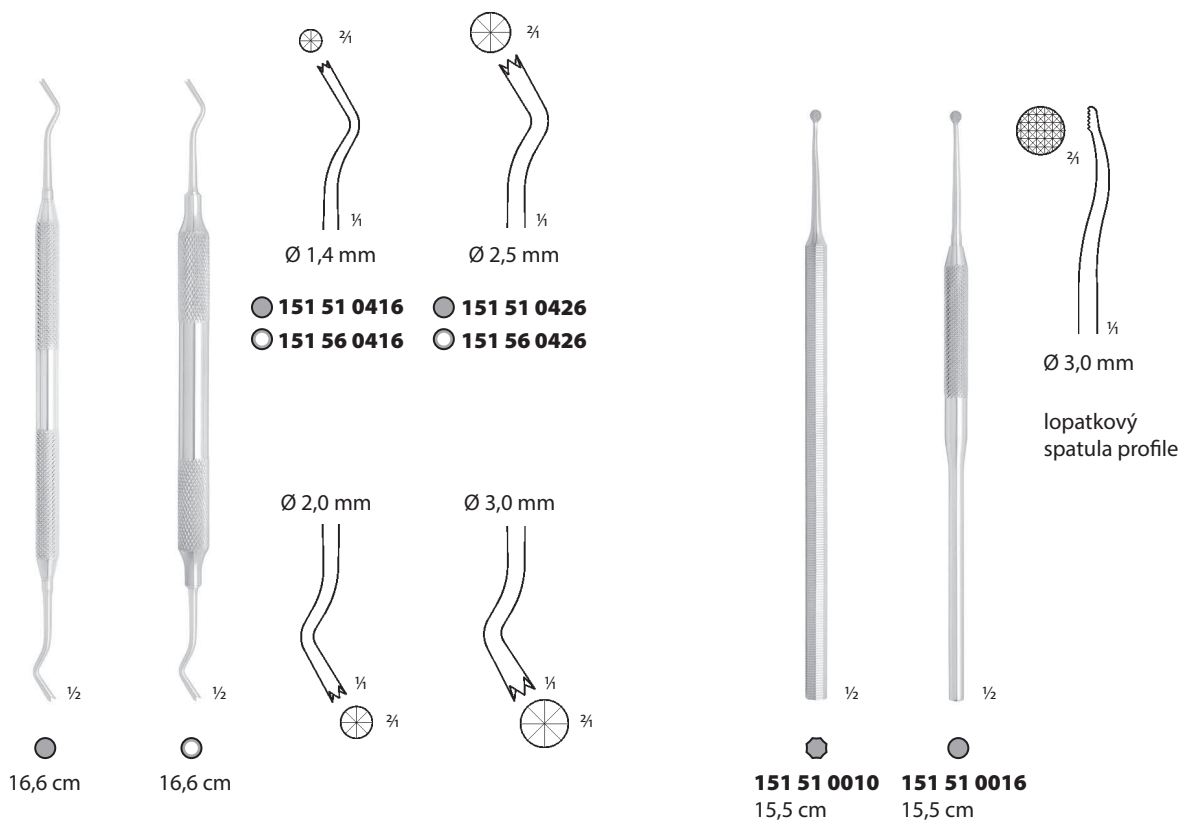

CPÁTKA
FILLING INSTRUMENTS

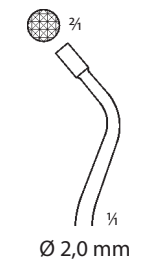
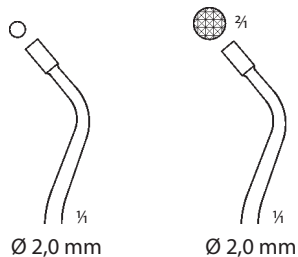

- 151 51 0096
- 151 56 0096
- 151 51 0097
- 151 56 0097

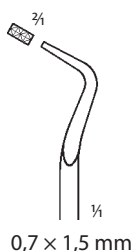
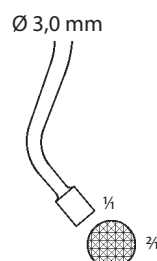
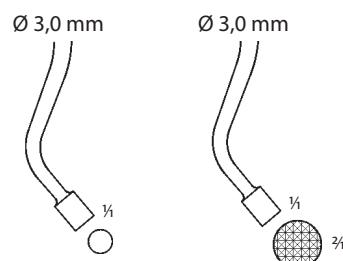

- 151 51 0320
- 151 51 0326
- 151 56 0326

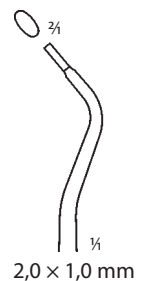
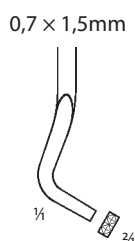

- 151 51 3146

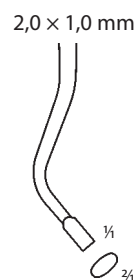

●	osmihranné držátko – octagonal handle	5,5 mm
○	plné držátko – round solid handle	Ø 6,0 mm
○	duté držátko – hollow handle	Ø 8,0 mm

151 5X XXXX	nerez – stainless steel
151 5X XXXX	TiN povlak – TiN surface



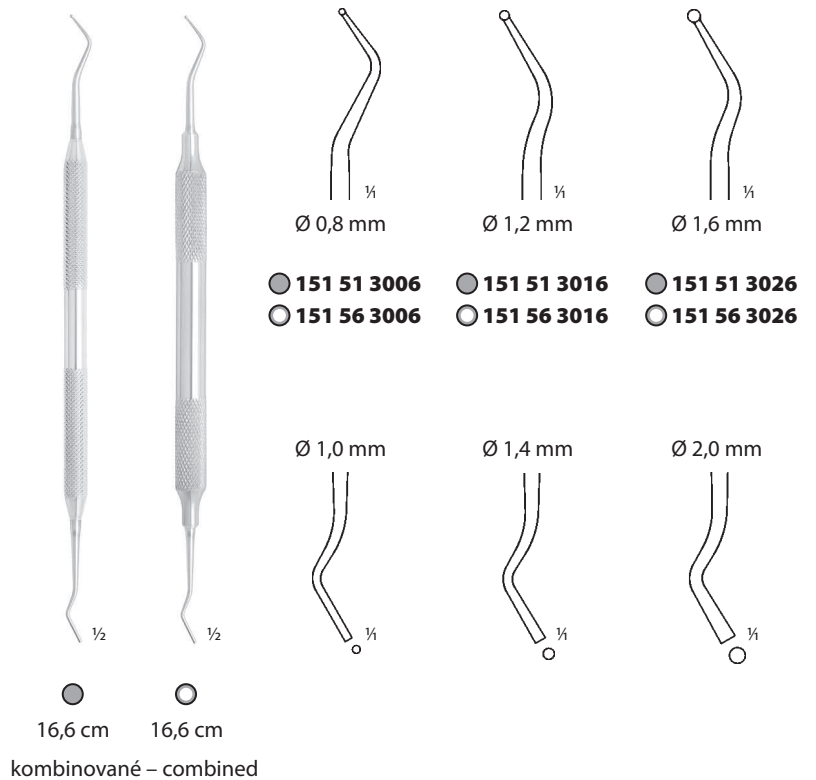
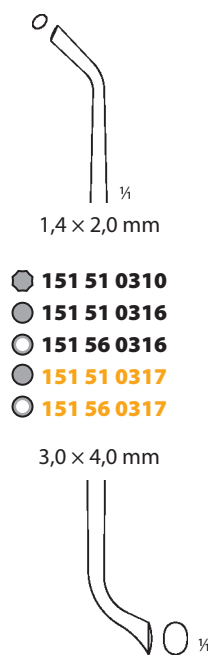
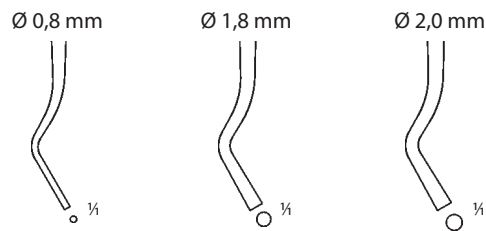
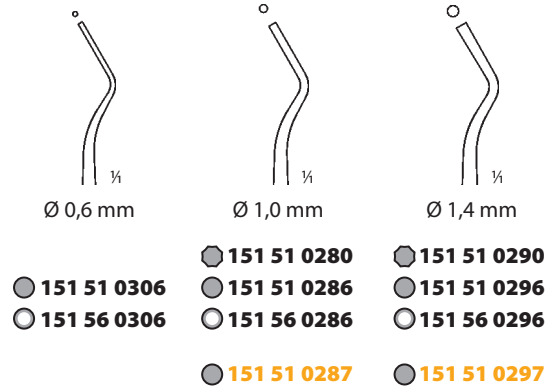

● osmihřanné držátko – octagonal handle	5,5 mm
● plné držátko – round solid handle	Ø 6,0 mm
● duté držátko – hollow handle	Ø 8,0 mm

151 5X XXXX	nerez – stainless steel
151 5X XXXX	TiN povlak – TiN surface



CPÁTKA
FILLING INSTRUMENTS

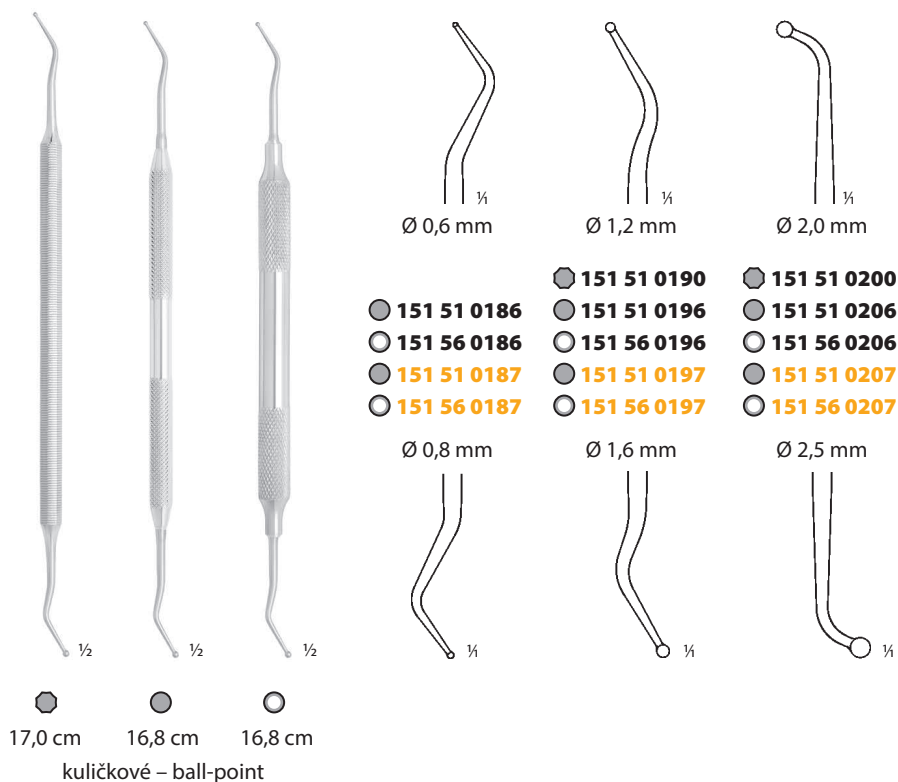

CPÁTKA KOŘENOVÁ
FILLING INSTRUMENTS

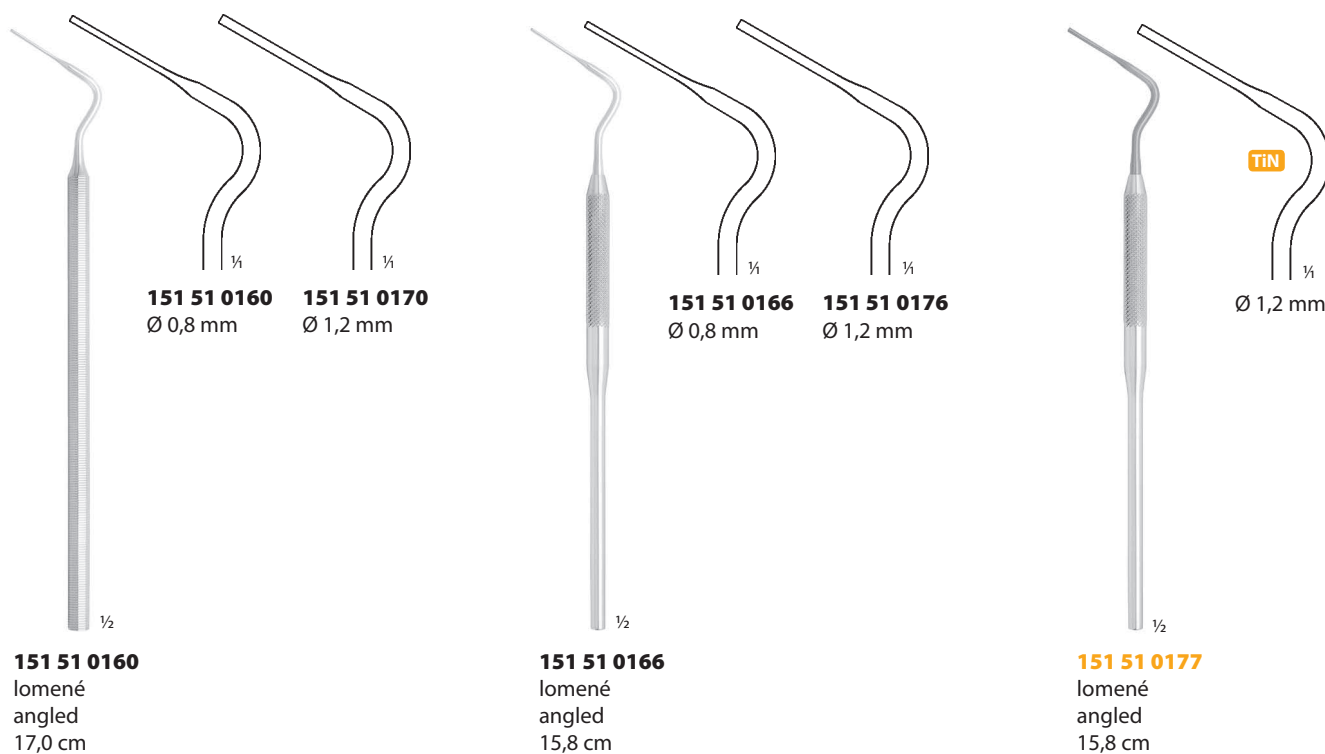

● osmihranné držátko – octagonal handle	5,5 mm
○ plné držátko – round solid handle	Ø 6,0 mm
○ duté držátko – hollow handle	Ø 8,0 mm

151 5X XXXX	nerez – stainless steel
151 5X XXXX	TiN povlak – TiN surface



CPÁTKA VLÁKNA DO SULKU
FIBRE FILLING INSTRUMENTS

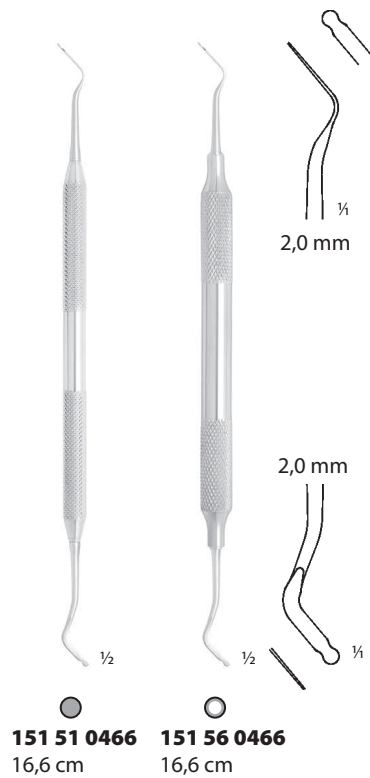

ZAVADĚČE RETRAKČNÍCH VLÁKEN
RETENTIVE FIBRE INSTRUMENTS

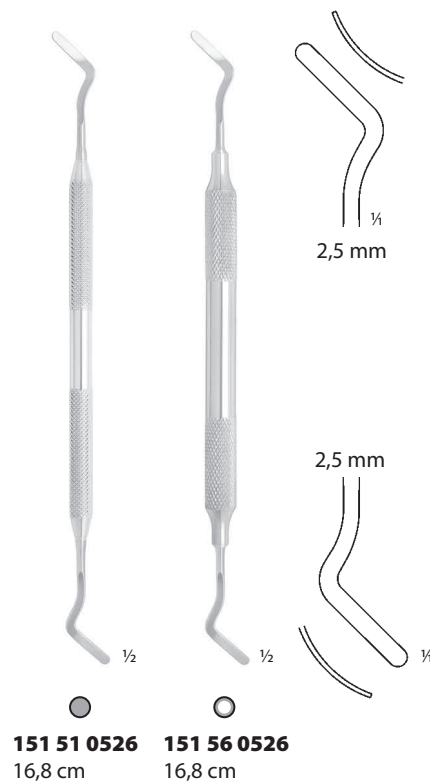
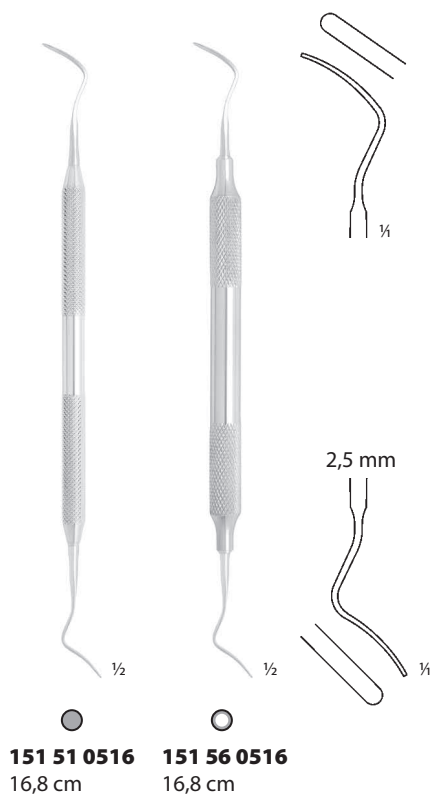

HLADÍTKA SE CPÁTKEM
SPATULAS – FILLING INSTRUMENTS

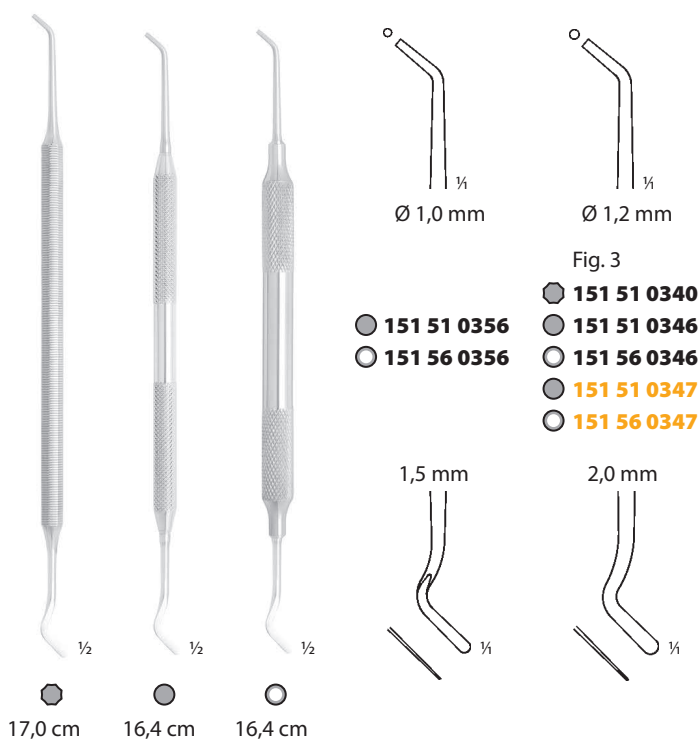
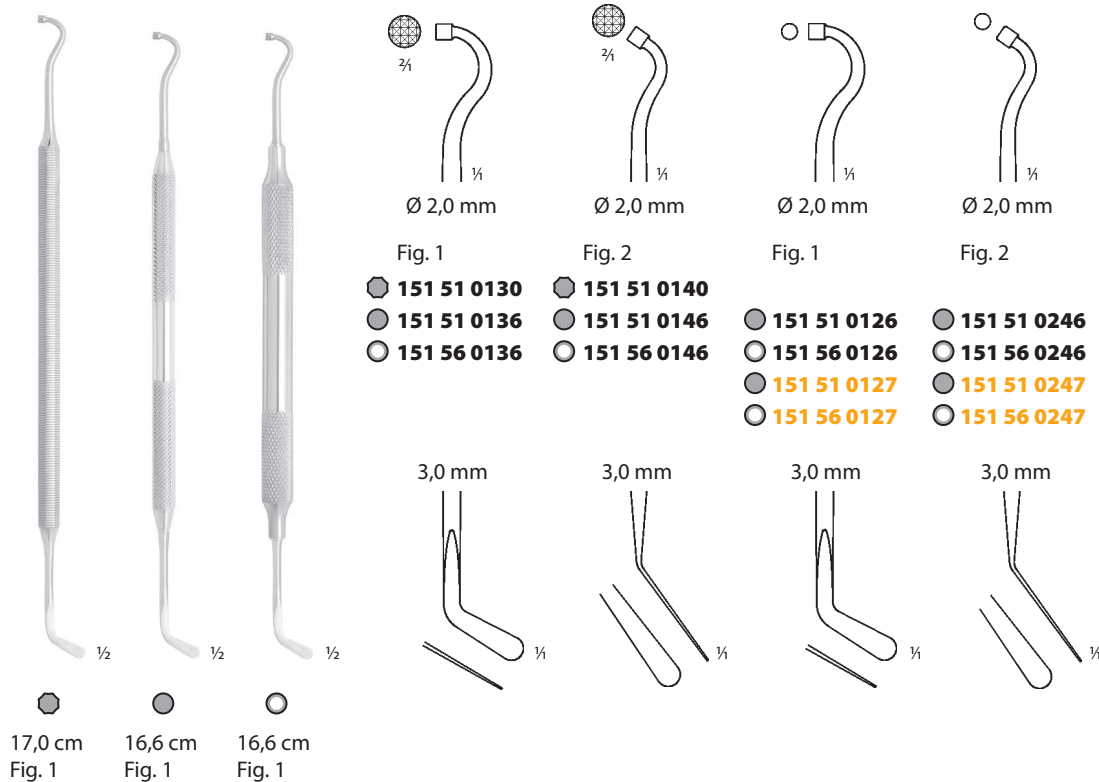

	osmihranné držátko – octagonal handle	5,5 mm
	plné držátko – round solid handle	Ø 6,0 mm
	duté držátko – hollow handle	Ø 8,0 mm

151 5X XXXX	nerez – stainless steel
151 5X XXXX	TiN povlak – TiN surface



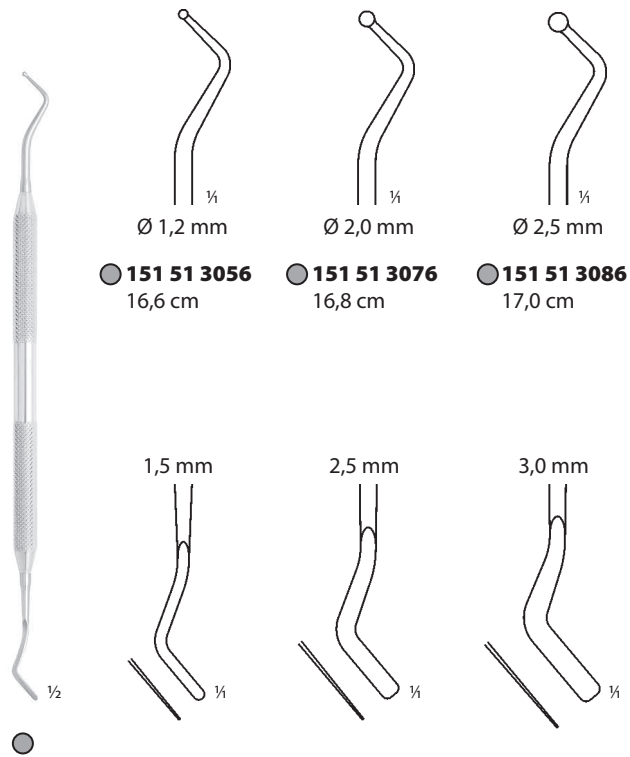

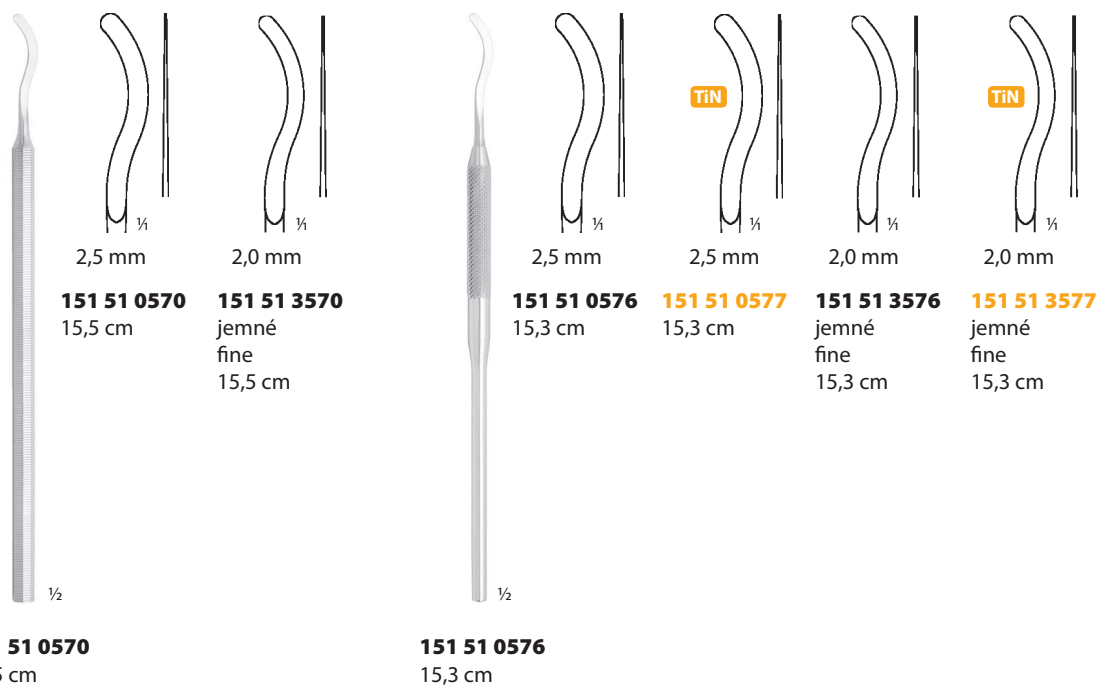
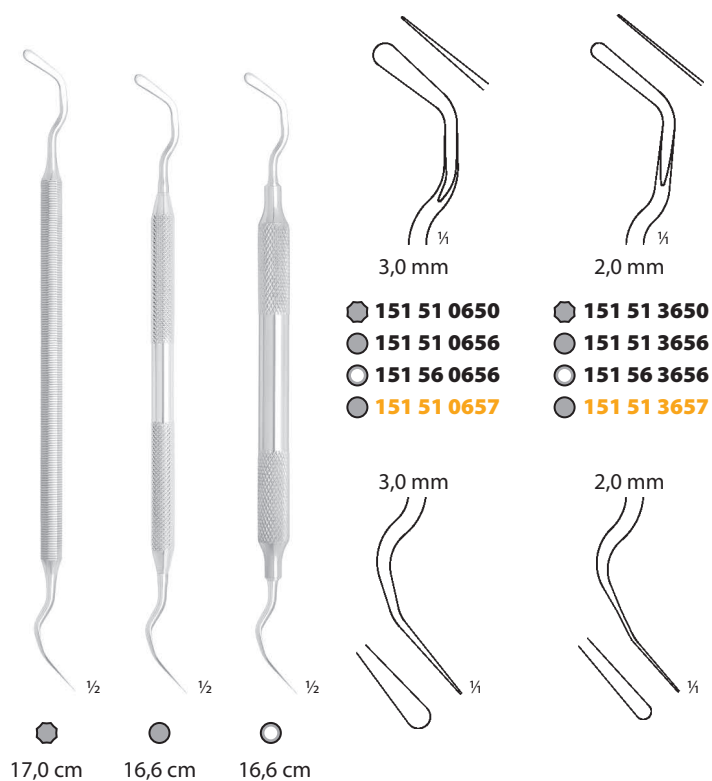
HLADÍTKA PRUŽNÁ
SPATULAS FLEXIBLEHLADÍTKA 3× LOMENÁ
SPATULAS 3× ANGLED

○ osmihranné držátko – octagonal handle	5,5 mm
● plné držátko – round solid handle	Ø 6,0 mm
○ duté držátko – hollow handle	Ø 8,0 mm

151 5X XXXX	nerez – stainless steel
151 5X XXXX	TiN povlak – TiN surface



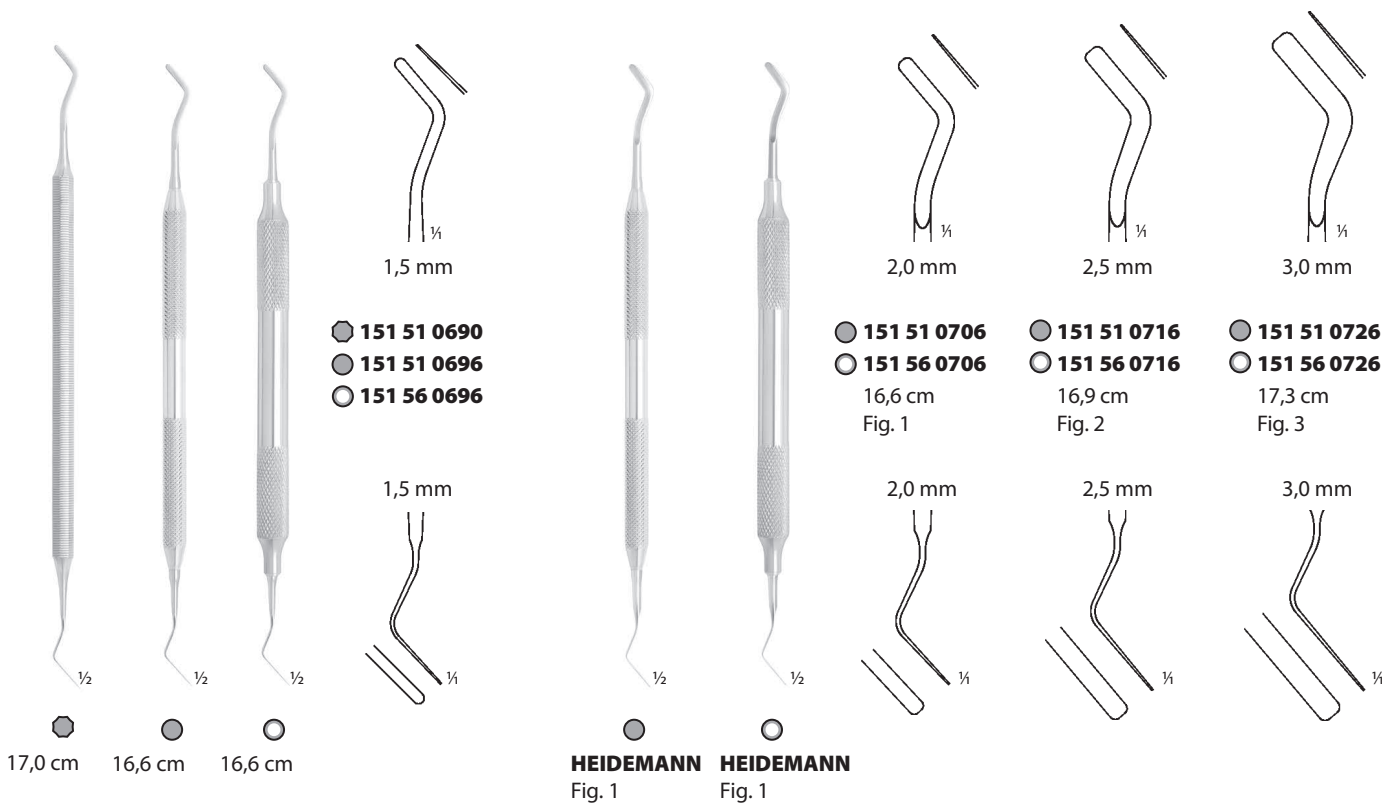
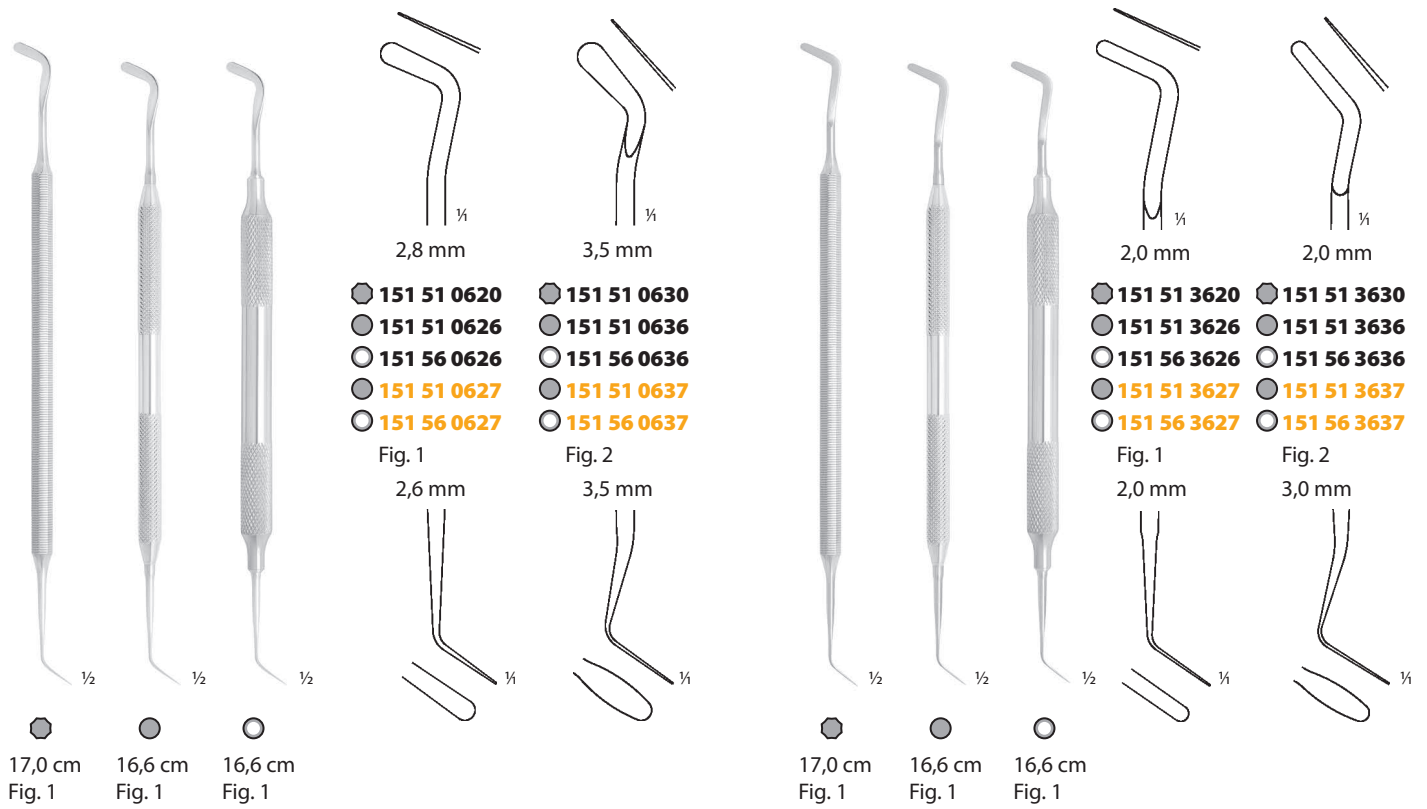

	osmihranné držátko – octagonal handle	5,5 mm
	plné držátko – round solid handle	Ø 6,0 mm
	duté držátko – hollow handle	Ø 8,0 mm

	151 5X XXXX	nerez – stainless steel
	151 5X XXXX	TiN povlak – TiN surface



NÁSTROJE PRO VÝPLNĚ
FILLING INSTRUMENTS

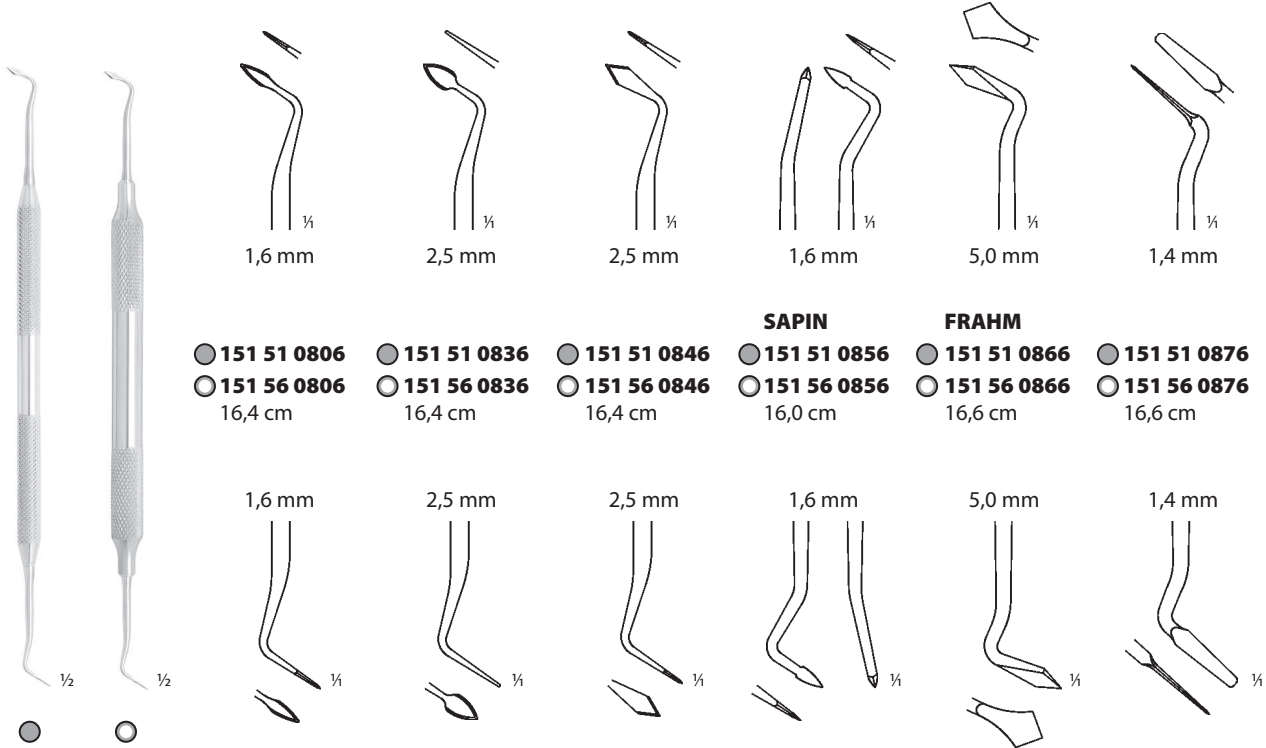

- | | | | | | | |
|---------------|---------------|---------------|---------------|---------------|---------------|---------------|
| ● 151 51 0806 | ● 151 51 0836 | ● 151 51 0846 | SAPIN | FRAHM | ● 151 51 0866 | ● 151 51 0876 |
| ○ 151 56 0806 | ○ 151 56 0836 | ○ 151 56 0846 | ● 151 51 0856 | ● 151 51 0866 | ○ 151 56 0866 | ○ 151 56 0876 |
| 16,4 cm | 16,4 cm | 16,4 cm | 16,0 cm | 16,6 cm | 16,6 cm | 16,6 cm |

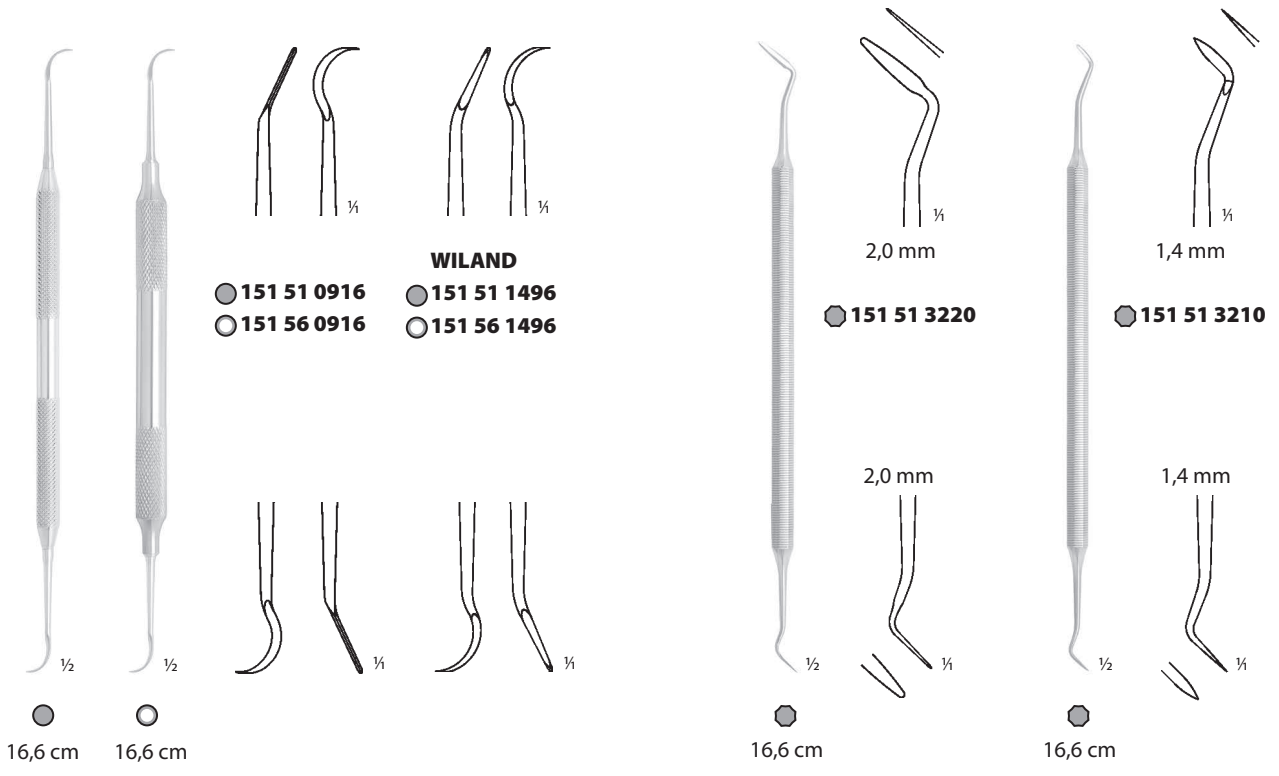

- | | | | | |
|---------------|---------------|---------------|---------------|---------------|
| ● 151 51 0916 | WILAND | ● 151 51 1496 | ● 151 51 3220 | ● 151 51 3210 |
| ○ 151 56 0916 | ○ 151 56 1496 | | | |

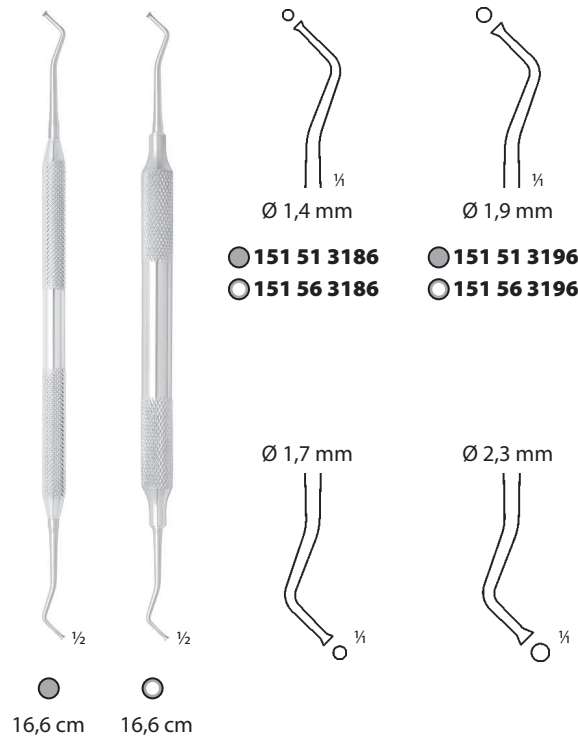
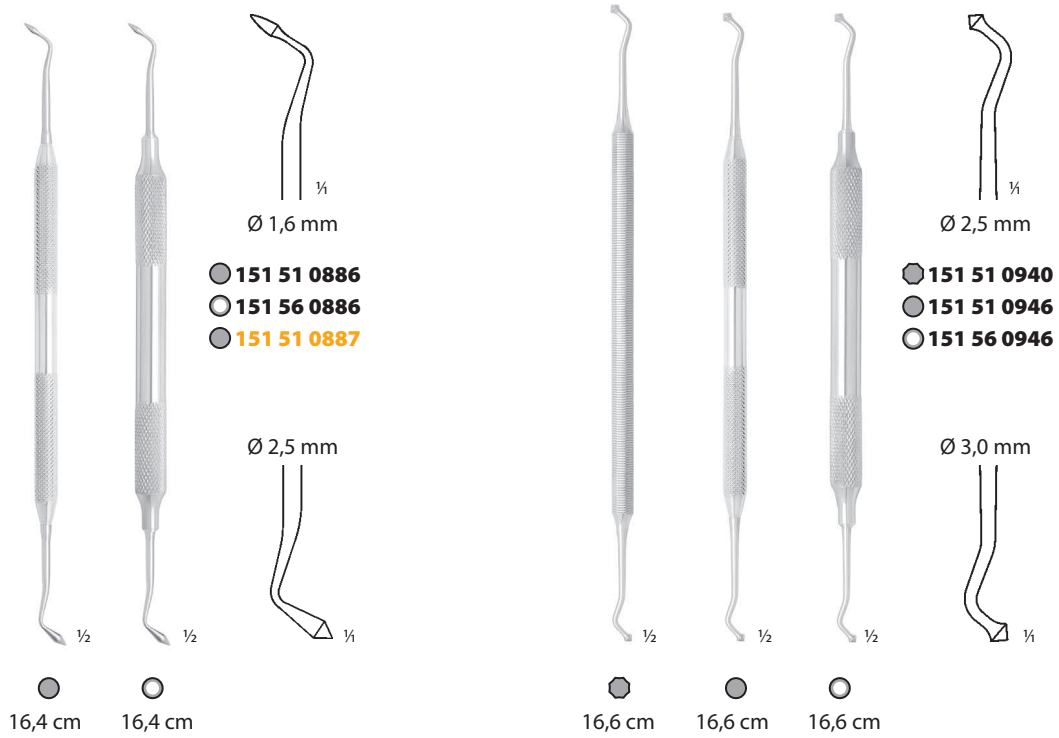

●	osmihranné držátko – octagonal handle	5,5 mm
○	plné držátko – round solid handle	Ø 6,0 mm
○	duté držátko – hollow handle	Ø 8,0 mm

●	151 5X XXXX	nerez – stainless steel
○	151 5X XXXX	TiN povlak – TiN surface



NÁSTROJE PRO VÝPLNĚ
FILLING INSTRUMENTS

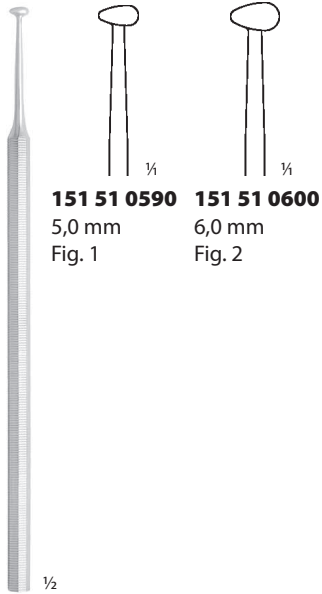

151 51 0590
kapkovitý
guttate profile
15,5 cm

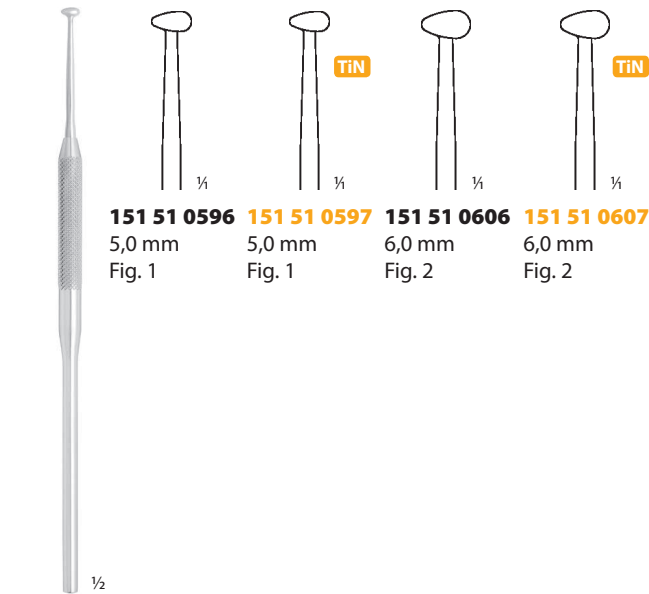

151 51 0596
kapkovitý
guttate profile
15,3 cm

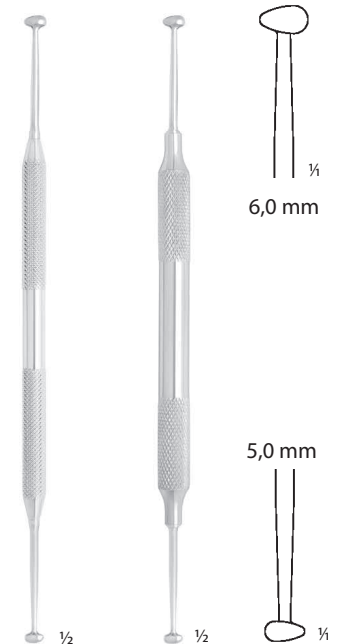

151 51 0616 16,6 cm
151 56 0616 16,6 cm

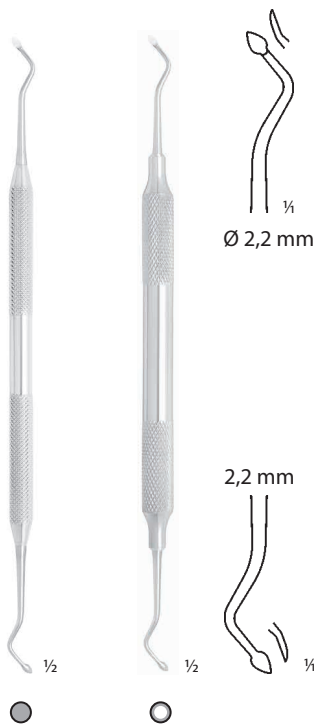

151 51 0896 16,8 cm
151 56 0896 16,8 cm

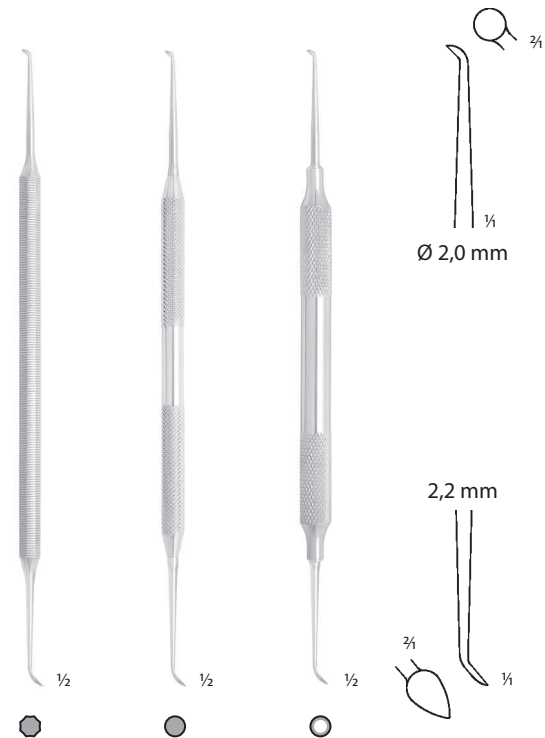

DISCOID-CLEOID
151 51 0930 16,8 cm
151 51 0936 16,8 cm
151 56 0936 16,8 cm

○	osmihranné držátko – octagonal handle	5,5 mm
●	plné držátko – round solid handle	Ø 6,0 mm
○	duté držátko – hollow handle	Ø 8,0 mm

151 5X XXXX	nerez – stainless steel
151 5X XXXX	TiN povlak – TiN surface



SEPARAČNÍ PÁSKY DIAMANTOVANÉ
SEPARATION DIAMOND STRIPS

120 × 3 mm		151 51 2020 D40 velmi jemná zrnitost very fine grain	151 51 2021 D64 jemná zrnitost fine grain	151 51 2022 D107 střední zrnitost medium grain
120 × 4 mm		151 51 2030 D40 velmi jemná zrnitost very fine grain	151 51 2031 D64 jemná zrnitost fine grain	151 51 2032 D107 střední zrnitost medium grain
120 × 6 mm		151 51 2040 D40 velmi jemná zrnitost very fine grain	151 51 2041 D64 jemná zrnitost fine grain	151 51 2042 D107 střední zrnitost medium grain
120 × 8 mm		151 51 2051 D64 jemná zrnitost fine grain	151 51 2052 D107 střední zrnitost medium grain	

SEPARAČNÍ PÁSKY HLADKÉ
SEPARATION STRIPS – SMOOTH

151 51 1010 120 × 6 mm	151 51 1020 120 × 8 mm

POZNÁMKY: Baleno po 100 ks.

NOTES: Packing of 100 pcs.

SVORKY NA PÁSKY
STRIP CLAMPS



151 51 0970
zahnutá 40°
curved 40°
3,3 cm



151 51 0980
zahnutá 90°
curved 90°
2,5 cm



PISTOLE NA AMALGAM
AMALGAM PISTOL

151 51 0760
kovový píst
metal piston
15,0 cm

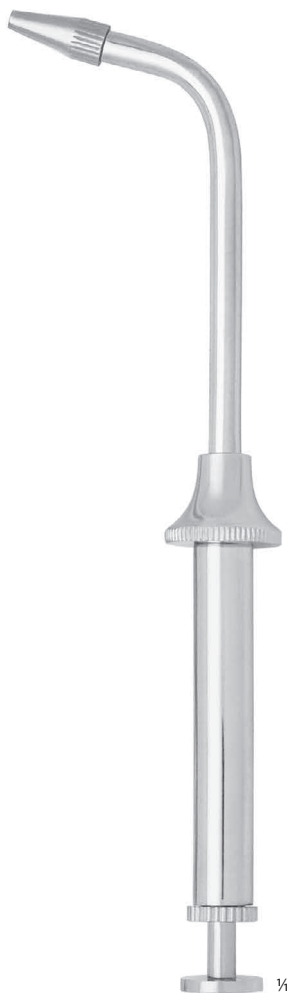

151 51 0770
kovový píst
metal piston
13,0 cm



151 51 0780
plastová
plastic
16,0 cm



Lopátka na mícháání
Mixing spatula
121 52 0080
21,0 cm
27 mm

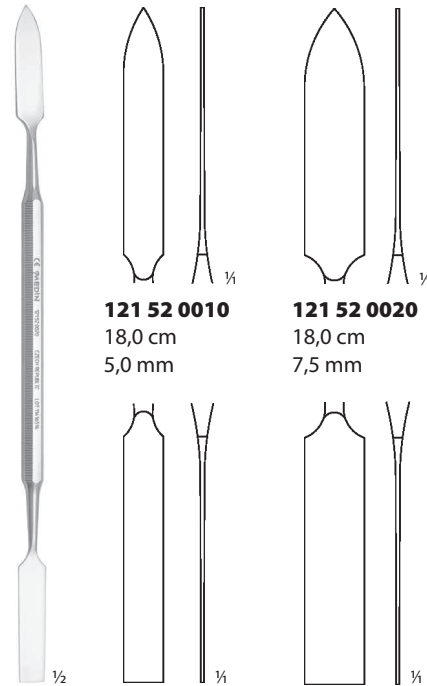

121 52 0010
18,0 cm
5,0 mm

121 52 0020
18,0 cm
7,5 mm

Lopátka na cement
Cement spatula
121 52 0020
oboustranná
double faced
18,0 cm



IVORY
156 52 0010
malá
small
2,5 cm



IVORY
156 52 0020
střední
medium
3,6 cm



IVORY
156 52 0030
velká
large
3,5 cm

POZNÁMKY: Baleno po 20 ks.
NOTES: Packing of 20 pcs.



IVORY
Napínač matric
Matrix retainer
156 52 0050
7,0 cm



IVORY
Separátor
Separator
156 52 0070
6,7 cm

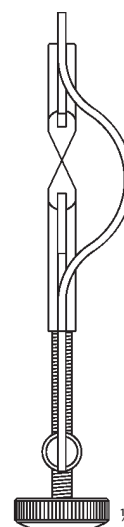



Matrice pásková
Matrix band

156 91 0001	5 mm	1 m
156 91 0002	6 mm	1 m
156 91 0003	7 mm	1 m

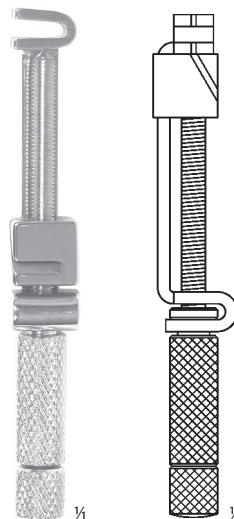

Napínač matric univerzální
Universal retainer

156 52 0300
6,4 cm

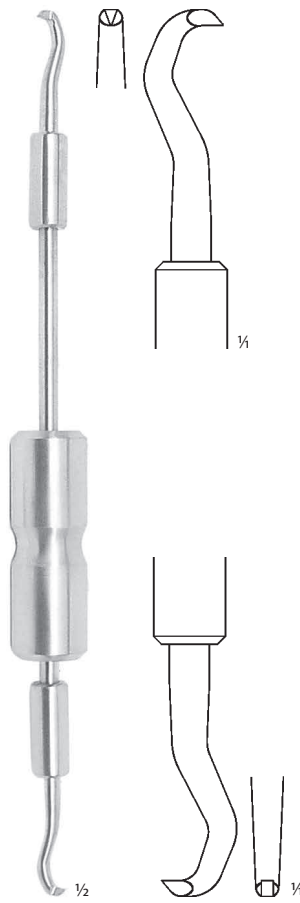

123 50 0610
23,3 cm



D

PARODONTOLOGIE
PERIODONTIA

Sondy, pátridla	Probes	101
Kyrety	Curettes	102–105
Nástroje na zubní kámen	Scalers	106–111
Pilníky	Files	112

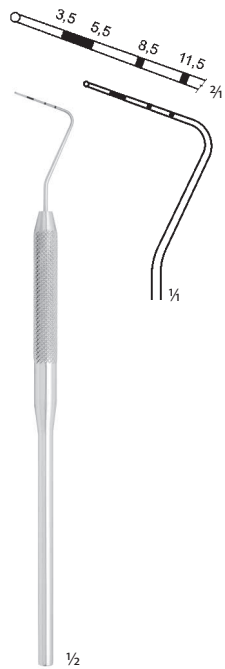

Sonda parodontologická
Periodontal probe
133 50 0106
3,5; 5,5; 8,5; 11,5 mm
WHO
15,2 cm

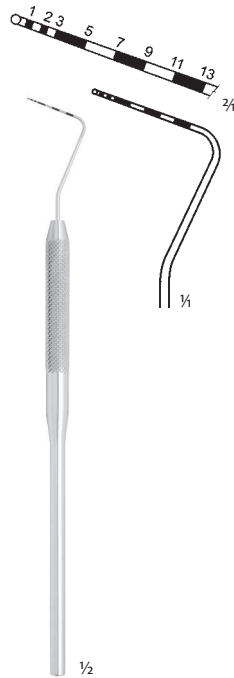

Sonda parodontologická
Periodontal probe
133 50 0116
1; 2; 3; 5; 7; 9; 11; 13 mm
15,2 cm



Explorer
Explorer
133 51 0226
15,5 cm

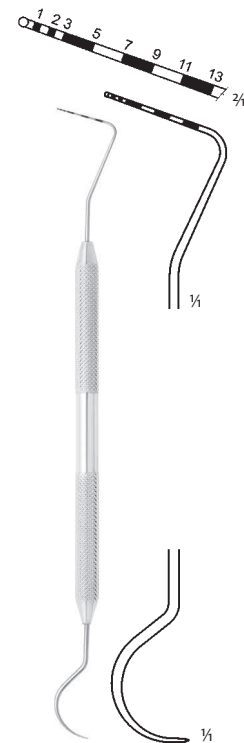

Sonda parodontologická s pátradlem
Periodontal and dental probe
133 99 0177
15,7 cm



NABERS
Furkační sonda
Furcation probe
133 58 0230
3-6-9-12
17,2 cm

KYRETY
CURETTES



GRACEY 1/2
126 58 0056
17,4 cm



GRACEY 3/4
126 58 0066
17,4 cm



GRACEY 5/6
126 58 0076
17,3 cm



GRACEY 7/8
126 58 0086
17,0 cm



GRACEY 9/10
126 58 0146
16,5 cm



GRACEY 11/12
126 58 0106
17,2 cm



GRACEY 13/14
126 58 0116
17,0 cm

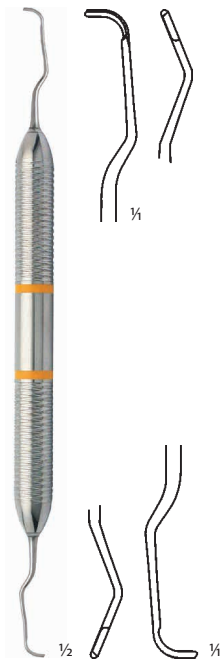

GRACEY 15/16
126 58 0126
17,1 cm

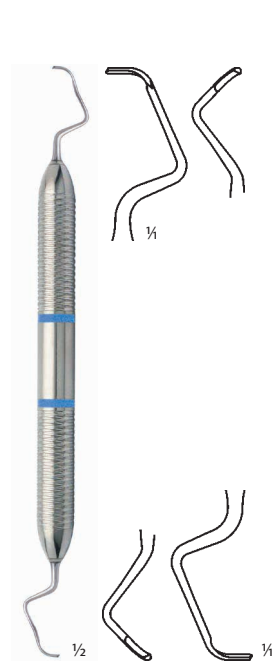

GRACEY 17/18
126 58 0136
15,6 cm

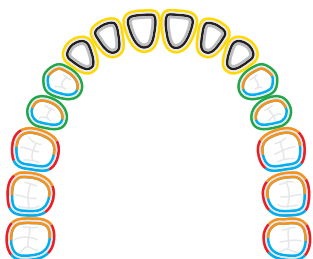

- GRACEY 1/2
- GRACEY 3/4
- GRACEY 5/6
- GRACEY 7/8
- GRACEY 9/10
- GRACEY 11/12
- GRACEY 13/14
- GRACEY 15/16
- GRACEY 17/18

řezáky, špičáky, premoláry
řezáky, špičáky, premoláry
řezáky, špičáky, premoláry
řezáky, špičáky, premoláry
premoláry, moláry
moláry
moláry – meziální plochy
moláry – distální plochy
moláry – meziální plochy
moláry – distální plochy

incisors, premolars
incisors, premolars
incisors, premolars
premolars, molars
molars
molars' mesial surfaces
molars' distal surfaces
molars' mesial surfaces
molars' distal surfaces



MINI GRACEY 1/2
126 58 1056
17,6 cm



MINI GRACEY 3/4
126 58 1066
17,4 cm



MINI GRACEY 5/6
126 58 1076
17,5 cm



MINI GRACEY 7/8
126 58 1086
17,1 cm



MINI GRACEY 9/10
126 58 1146
16,7 cm



MINI GRACEY 11/12
126 58 1106
17,4 cm



MINI GRACEY 13/14
126 58 1116
17,4 cm



MINI GRACEY 15/16
126 58 1126
17,2 cm

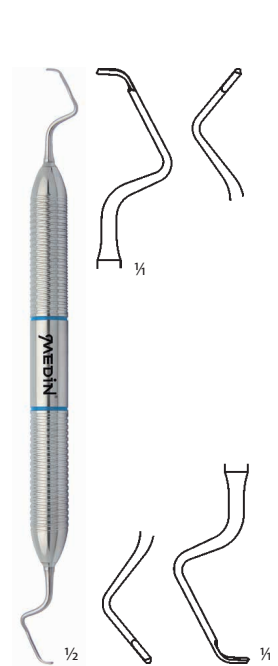

MINI GRACEY 17/18
126 58 1136
15,8 cm

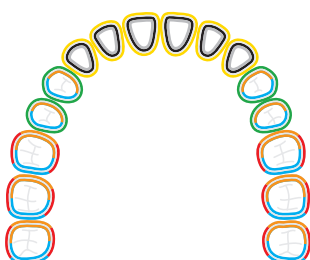

- MINI GRACEY 1/2
- MINI GRACEY 3/4
- MINI GRACEY 5/6
- MINI GRACEY 7/8
- MINI GRACEY 9/10
- MINI GRACEY 11/12
- MINI GRACEY 13/14
- MINI GRACEY 15/16
- MINI GRACEY 17/18

řezáky, špičáky, premoláry
řezáky, špičáky, premoláry
řezáky, špičáky, premoláry
premoláry, moláry
moláry
moláry – meziální plochy
moláry – distální plochy
moláry – meziální plochy
moláry – distální plochy

incisors, premolars
incisors, premolars
incisors, premolars
premolars, molars
molars
molars' mesial surfaces
molars' distal surfaces
molars' mesial surfaces
molars' distal surfaces

SOUBORY PARODONTOLOGICKÝCH NÁSTROJŮ
SETS OF PERIODONTAL INSTRUMENTS

Soubor parodontologických nástrojů, set 1
Set of periodontal instruments, set 1

139 50 0770

		ks / pcs
126 58 0056	Gracey kyreta 1/2; 17,4 cm	1
126 58 0066	Gracey kyreta 3/4; 17,4 cm	1
126 58 0076	Gracey kyreta 5/6; 17,3 cm	1
126 58 0086	Gracey kyreta 7/8; 17,0 cm	1
126 58 0096	Scaler oboustranný; 16,7 cm	1
126 58 0106	Gracey kyreta 11/12; 17,2 cm	1
126 58 0116	Gracey kyreta 13/14; 17,0 cm	1
126 58 0126	Gracey kyreta 15/16; 17,1 cm	1
126 58 0136	Gracey kyreta 17/18; 15,6 cm	1
126 58 0146	Gracey kyreta 9/10; 16,5 cm	1

Soubor parodontologických nástrojů, set 2
Set of periodontal instruments, set 2

139 50 0780

		ks / pcs
126 58 0076	Gracey kyreta 5/6; 17,3 cm	1
126 58 0086	Gracey kyreta 7/8; 17,0 cm	1
126 58 0096	Scaler oboustranný; 16,7 cm	1
126 58 0106	Gracey kyreta 11/12; 17,2 cm	1
126 58 0116	Gracey kyreta 13/14; 17,0 cm	1

Soubor parodontologických nástrojů mini, set 1
Set of mini periodontal instruments, set 1

139 50 0810

		ks / pcs
126 58 1056	Mini Gracey kyreta 1/2; 17,6 cm	1
126 58 1066	Mini Gracey kyreta 3/4; 17,4 cm	1
126 58 1076	Mini Gracey kyreta 5/6; 17,5 cm	1
126 58 1086	Mini Gracey kyreta 7/8; 17,1 cm	1
126 58 0096	Scaler oboustranný; 16,7 cm	1
126 58 1106	Mini Gracey kyreta 11/12; 17,4 cm	1
126 58 1116	Mini Gracey kyreta 13/14; 17,4 cm	1
126 58 1126	Mini Gracey kyreta 15/16; 17,2 cm	1
126 58 1136	Mini Gracey kyreta 17/18; 15,8 cm	1
126 58 1146	Mini Gracey kyreta 9/10; 16,7 cm	1



Furkační kyreta
Furcation curette
124 58 0010
17,2 cm



Furkační kyreta
Furcation curette
124 58 0020
17,6 cm

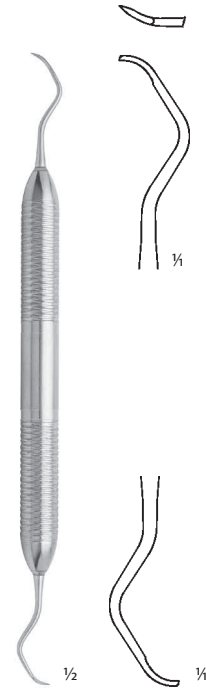

Scaler
Scaler
126 58 0096
16,7 cm

PŘÍSLUŠENSTVÍ PRO PARODONTOLOGII
PERIODONTAL ACCESSORIES



Brousek na ostření kyret
Sharpening stone for currettes
126 91 0162



Testovací tyčinka PMMA
Plastic test stick
126 53 0010
80 mm

NÁSTROJE NA ZUBNÍ KÁMEN
SCALERS



147 51 0010
15,5 cm

147 51 0018
15,5 cm

147 51 0016
15,5 cm

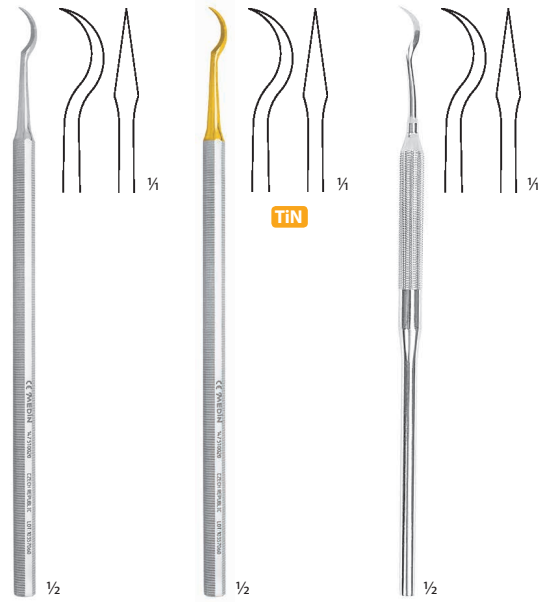

147 51 0020
15,5 cm

147 51 0028
15,5 cm

147 51 0026
15,5 cm

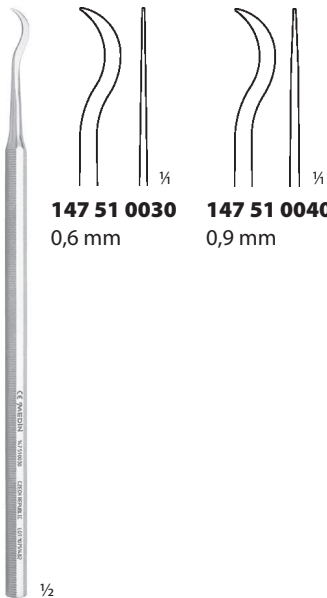

147 51 0030
0,6 mm

147 51 0040
0,9 mm

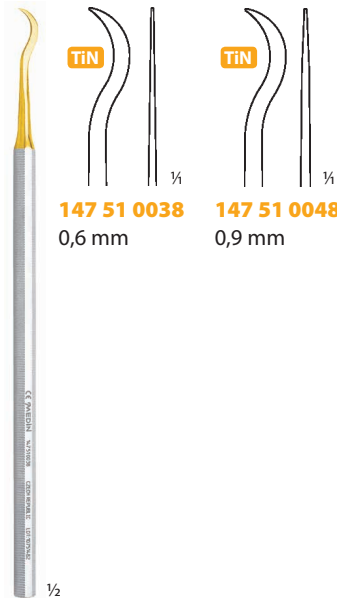

147 51 0038
0,6 mm

147 51 0048
0,9 mm

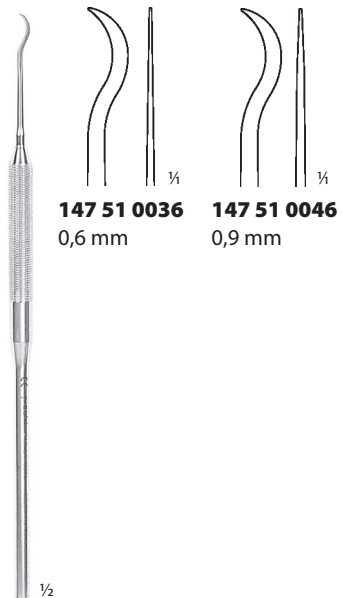

147 51 0036
0,6 mm

147 51 0046
0,9 mm

147 51 0030
15,5 cm

147 51 0038
15,5 cm

147 51 0036
15,5 cm



147 51 0060
2× lomený
double angled
15,5 cm

147 51 0068
2× lomený
double angled
15,5 cm

147 51 0066
2× lomený
double angled
15,5 cm

ŠKRABKY NA ZUBNÍ KÁMEN
SCALERS

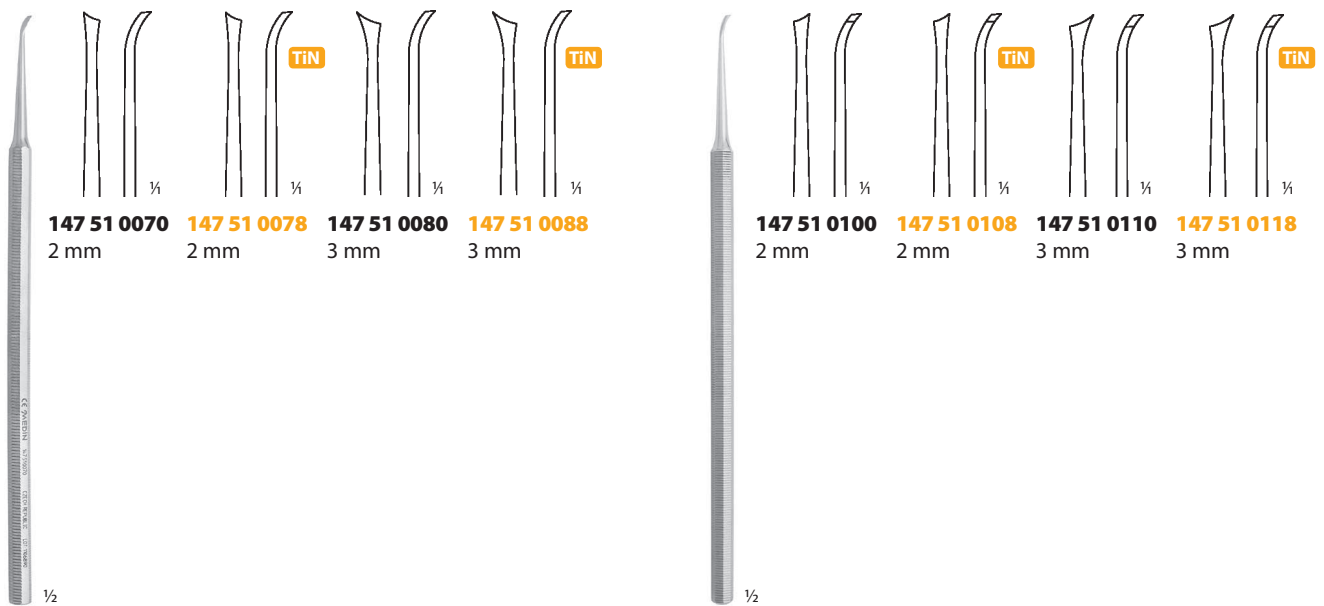

147 51 0070
2 mm

147 51 0078
2 mm

147 51 0080
3 mm

147 51 0088
3 mm

147 51 0100
2 mm

147 51 0108
2 mm

147 51 0110
3 mm

147 51 0118
3 mm

147 51 0070
pravá
right
15,5 cm

147 51 0100
levá
left
15,5 cm

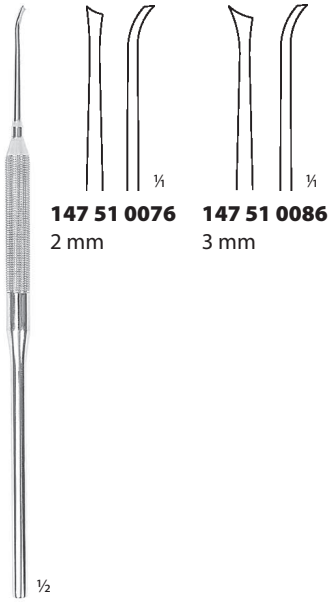
ŠKRABKY NA ZUBNÍ KÁMEN
SCALERS

147 51 0076
2 mm

147 51 0086
3 mm

147 51 0076
pravá
right
15,5 cm

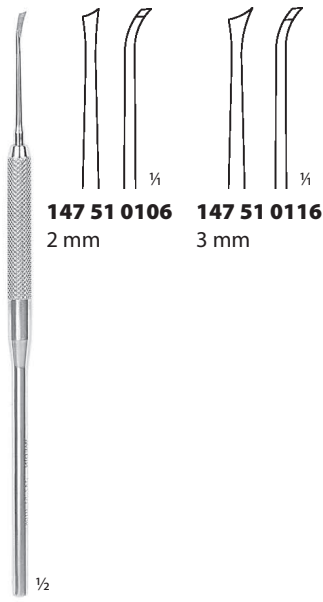

147 51 0106
2 mm

147 51 0116
3 mm

147 51 0106
levá
left
15,5 cm



1 mm

BLACK
147 51 0336
levá
left
15,5 cm



1 mm

BLACK
147 51 0346
pravá
right
15,5 cm

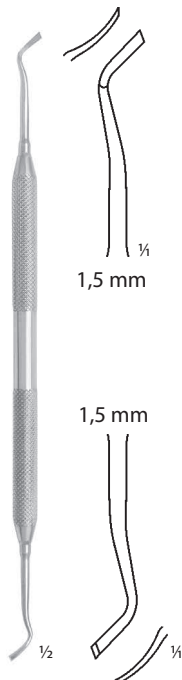
ZEŠIKMOVAČE GINGIVÁLNÍCH OKRAJŮ
GINGIVAL MARGIN TRIMMERS

1,5 mm

1,5 mm

147 51 0806
distální
distal
16,6 cm

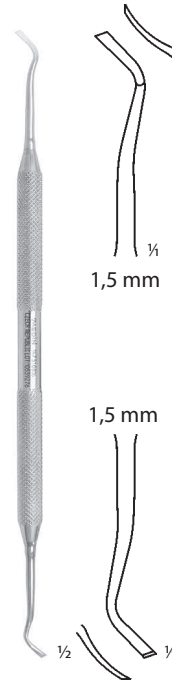

1,5 mm

1,5 mm

147 51 0816
meziální
mesial
16,5 cm

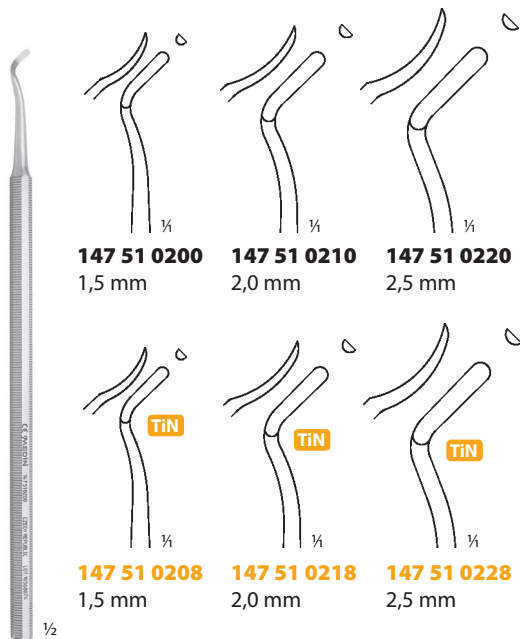

147 51 0200
pravý
right
15,5 cm

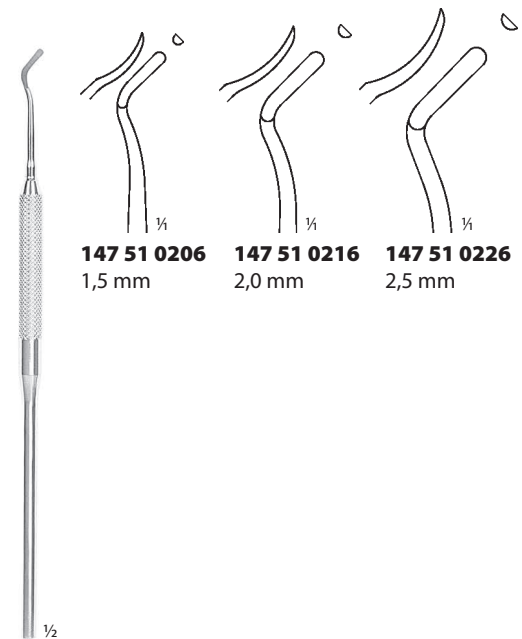

147 51 0206
pravý
right
15,5 cm

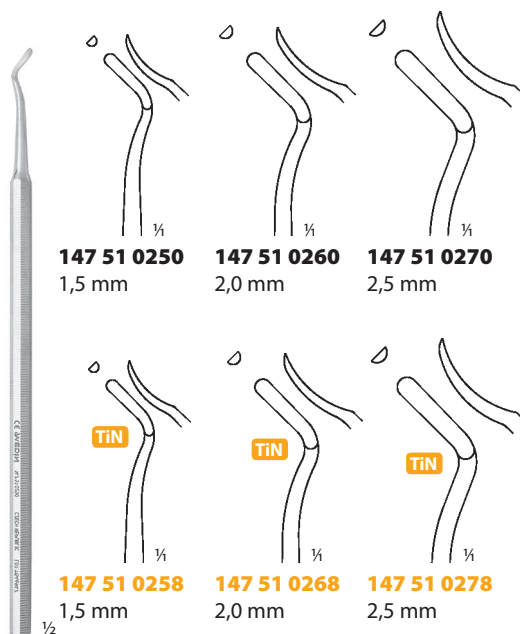

147 51 0250
levý
left
15,5 cm

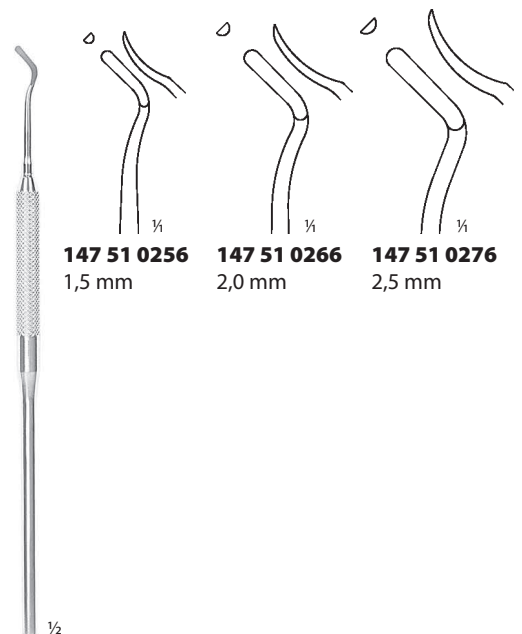

147 51 0256
levý
left
15,5 cm

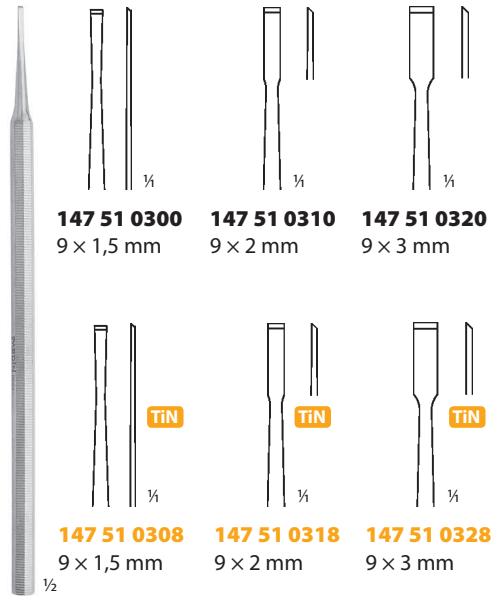
DLÁTKA NA SKLOVINU
ENAMEL CHISELS

BLACK
147 51 0300
15,5 cm

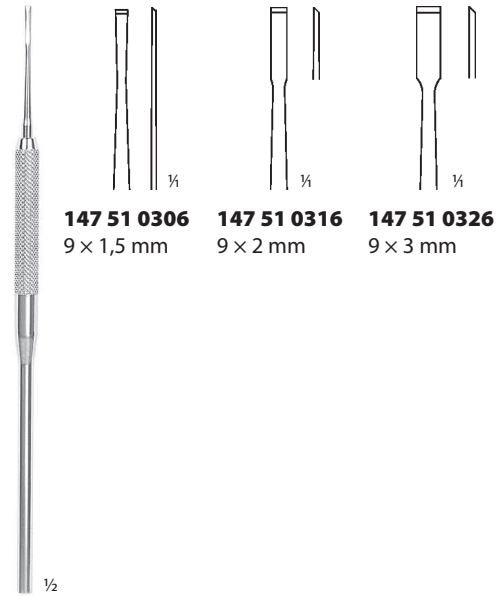

BLACK
147 51 0306
15,5 cm

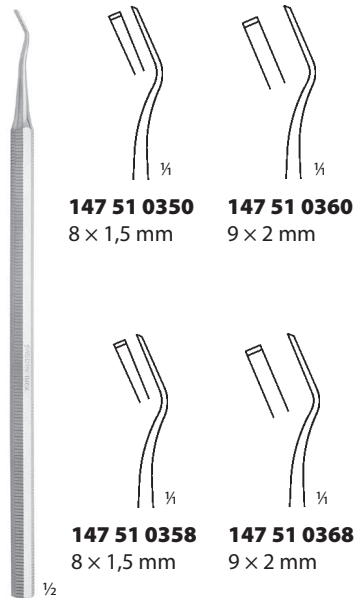

BLACK
147 51 0350
15,5 cm

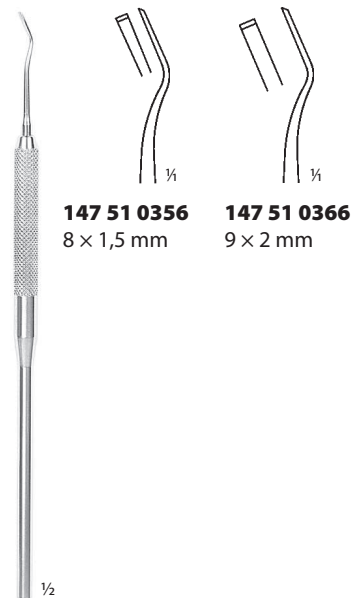

BLACK
147 51 0356
15,5 cm

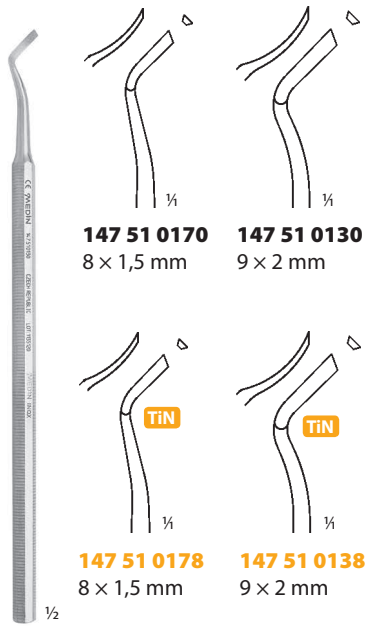

147 51 0170
8 × 1,5 mm

147 51 0130
9 × 2 mm

147 51 0178
8 × 1,5 mm

147 51 0138
9 × 2 mm

BLACK
147 51 0130
pravá
right
15,5 cm

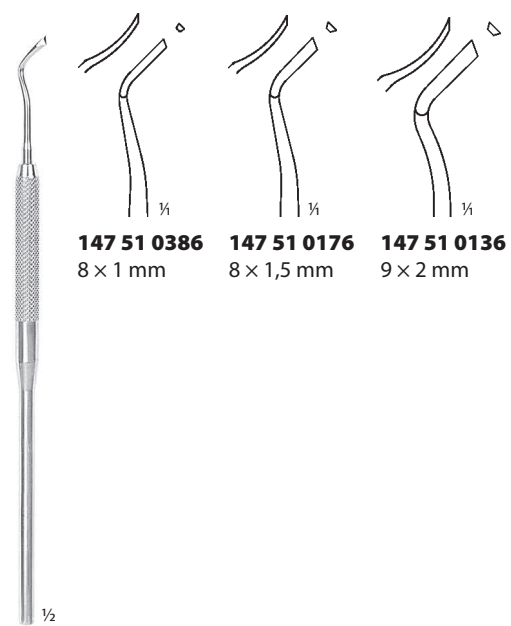

147 51 0386
8 × 1 mm

147 51 0176
8 × 1,5 mm

147 51 0136
9 × 2 mm

BLACK
147 51 0136
pravá
right
15,5 cm

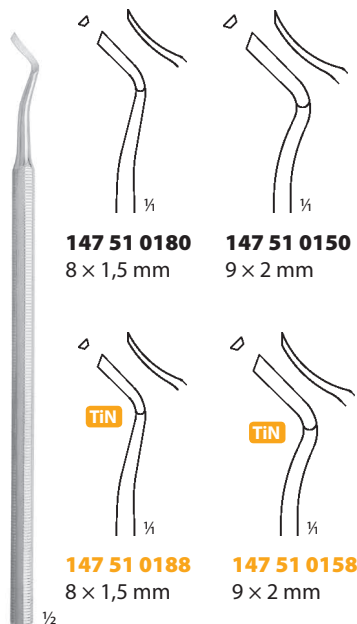

147 51 0180
8 × 1,5 mm

147 51 0150
9 × 2 mm

147 51 0188
8 × 1,5 mm

147 51 0158
9 × 2 mm

BLACK
147 51 0150
levá
left
15,5 cm

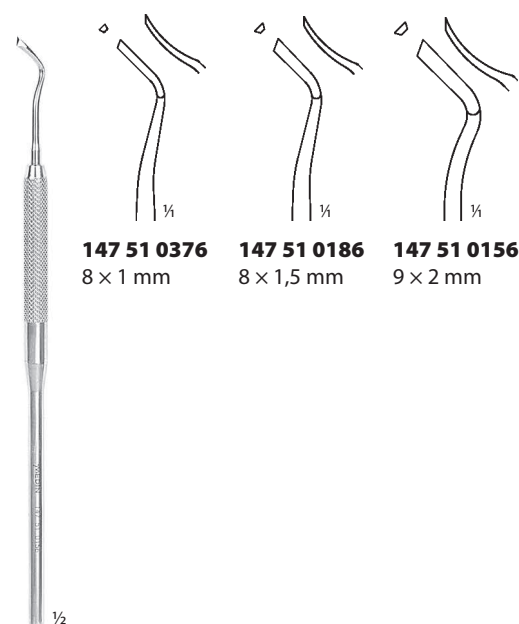

147 51 0376
8 × 1 mm

147 51 0186
8 × 1,5 mm

147 51 0156
9 × 2 mm

BLACK
147 51 0156
levá
left
15,5 cm

PILNÍKY DIAMANTOVANÉ – ZRNITOST STŘEDNÍ
DIAMOND FILES – GRIT MEDIUM**127 51 1206**15,0 cm
2 × 8 mm
Fig. 1**127 51 1216**15,0 cm
2 × 8 mm
Fig. 2**127 51 1226**15,2 cm
2 × 8 mm
Fig. 3**127 51 1236**15,2 cm
2 × 8 mm
Fig. 4**127 51 1306**jehlový
needle
15,0 cm**127 51 1206**

15,0 cm

PILNÍKY DIAMANTOVANÉ – ZRNITOST HRUBÁ
DIAMOND FILES – GRIT COARSE**127 51 1316**15,0 cm
2 × 8 mm
Fig. 5**127 51 1326**15,0 cm
2 × 8 mm
Fig. 6**127 51 1336**15,0 cm
2 × 8 mm
Fig. 7**127 51 1346**15,0 cm
2 × 8 mm
Fig. 8**127 51 1316**

15,0 cm

E

LABORATOŘ
LABORATORY



Pinzety	Forceps	115
Nůžky	Scissors	116
Pilky	Saws	116
Kleště úchopné	Grasping Forceps	117
Kleště štípací	Cutting Rongeurs	117
Kleště úchopné	Grasping Forceps	118–120
Lopatky	Spatulas	121
Lžičky laboratorní	Laboratory Spoons	121
Stomatologické soubory	Stomatological Sets	122
Nástroje modelovací	Modelling Instruments	123–124
Kladiva	Mallets	125
Kyvety, třmeny, lisy	Flasks, Claps, Presses	126
Pomůcky pro lití	Casting Devices	127–128
Zubní náhrady	Tooth Replacement	129
Otiskovací lžice	Impression Trays	129–130



Pinzeta laboratorní
Cross-action forceps
114 52 0100
15,3 cm



Pinzeta laboratorní
Cross-action forceps
114 52 0101
15,3 cm

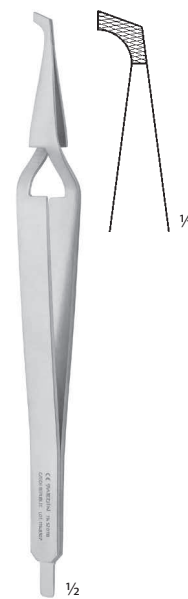

Pinzeta zkřížená se šroubovákem
Cross-action forceps with screwdriver
114 52 0110
15,5 cm

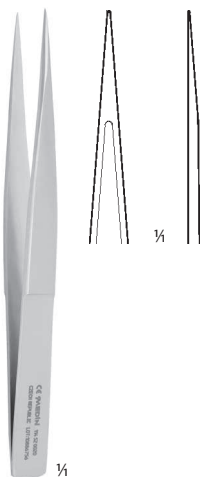

Pinzeta laboratorní
Laboratory forceps
114 52 0020
hrotnatá
pointed
12,5 cm



Pinzeta laboratorní
Laboratory forceps
114 52 0030
12,5 cm

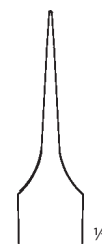

114 52 0040
jemná
fine
12,5 cm
0,4 mm

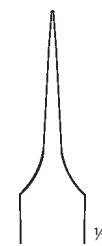

114 52 0050
jemná
fine
11,0 cm
0,3 mm

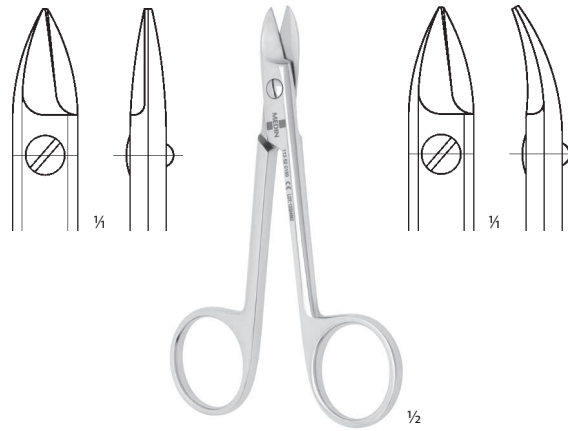

114 52 0060
jemná
fine
11,0 cm
0,4 mm

NŮŽKY NA KORUNKY
CROWN SCISSORS

113 52 0150
rovné
straight

11,0 cm

113 52 0160
zahnuté
curved

PILKY STOMATOLOGICKÉ
STOMATOLOGICAL SAWS

Upínací rám pilky stomatologické
Frame of stomatological saw
127 50 0150
190 x 65 cm

List k pilce stomatologické
Blade of stomatological saw
127 50 0001
7,3 cm



Kleště na kelímky
Crucible forceps
117 52 0770
50,0 cm



Kleště na kelímky
Crucible forceps
117 52 0780
27,5 cm

KLEŠTĚ ŠTÍPACÍ NA DRÁT
WIRE CUTTING FORCEPS



116 91 0001
14,5 cm
pro měkký drát do průměru 1,5 mm
pro tvrdý drát do průměru 1,0 mm
for soft wires up to diameter 1,5 mm
for hard wires up to diameter 1,0 mm



116 91 0005
17,0 cm
pro tvrdý drát do průměru 1,5 mm
for hard wires up to diameter 1,5 mm

KLEŠTĚ LABORATORNÍ OHÝBACÍ
LABORATORY BENDING FORCEPS**117 52 0700**

13,5 cm

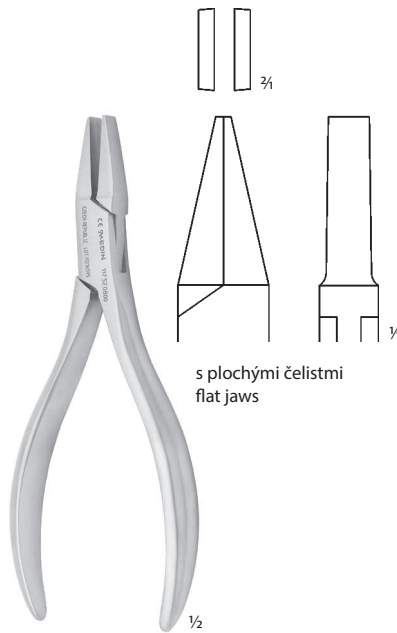
pro tvrdý drát do průměru 0,8 mm
for hard wires up to diameter 0,8 mm**117 52 0800**

13,4 cm

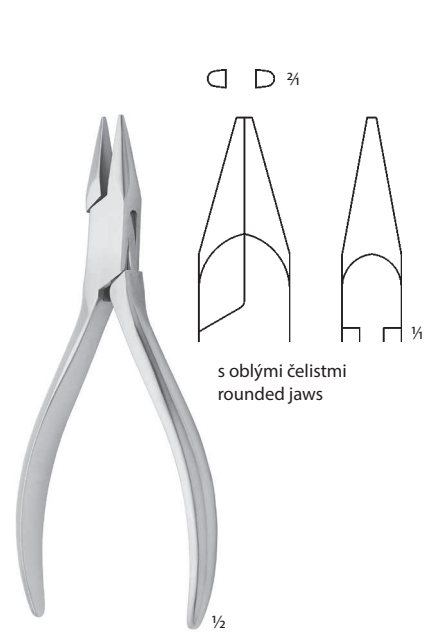
pro tvrdý drát do průměru 1,2 mm
for hard wires up to diameter 1,2 mm**117 52 0810**

13,4 cm

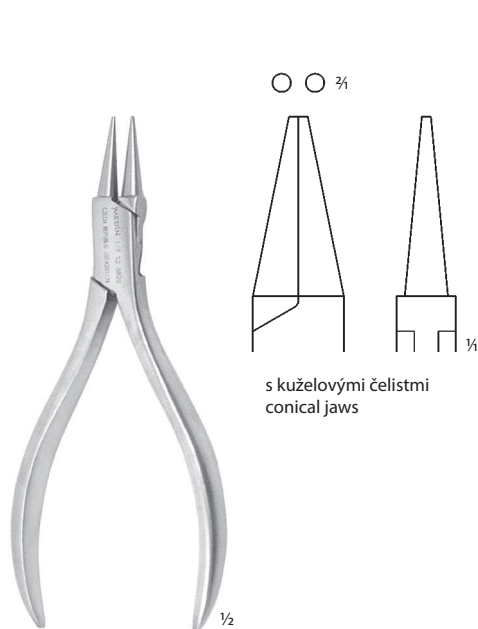
pro tvrdý drát do průměru 1,1 mm
for hard wires up to diameter 1,1 mm**117 52 0820**

13,4 cm

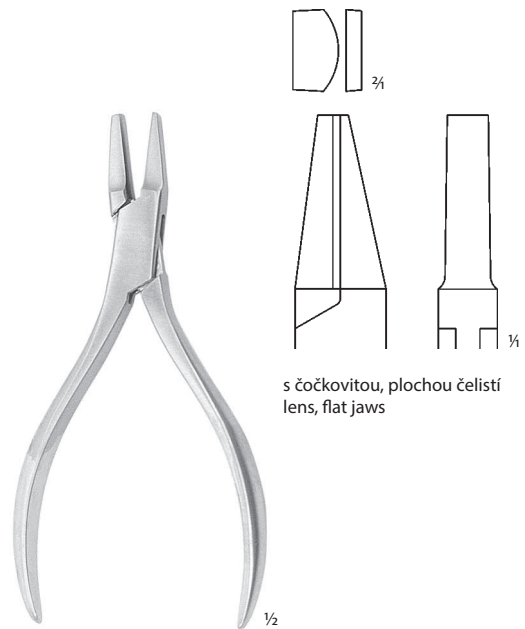
pro tvrdý drát do průměru 1,2 mm
for hard wires up to diameter 1,2 mm**117 52 0830**

13,4 cm

pro tvrdý drát do průměru 1,4 mm
for hard wires up to diameter 1,4 mm

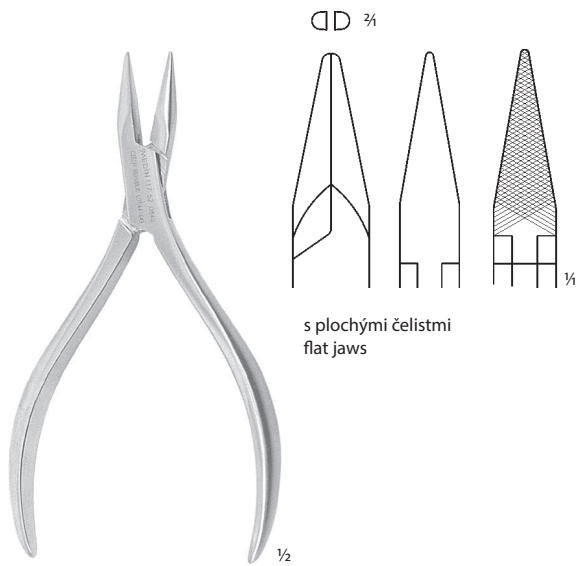

117 52 0840

13,5 cm

pro tvrdý drát do průměru 1,2 mm
for hard wires up to diameter 1,2 mm
Fig. 1

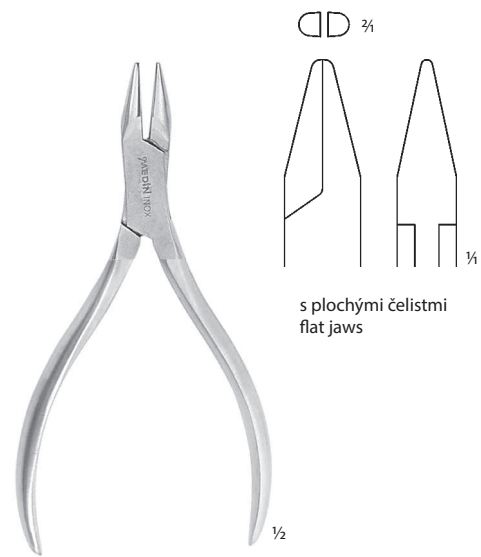

117 52 0870

13,0 cm

pro tvrdý drát do průměru 1,2 mm
for hard wires up to diameter 1,2 mm
Fig. 4

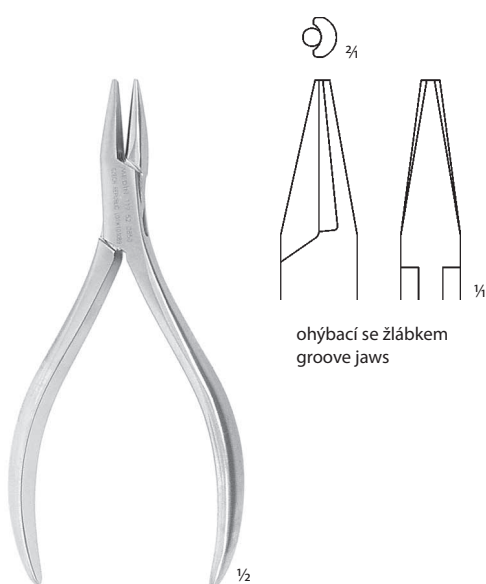

117 52 0850

13,3 cm

pro tvrdý drát do průměru 0,8 mm
for hard wires up to diameter 0,8 mm
Fig. 2

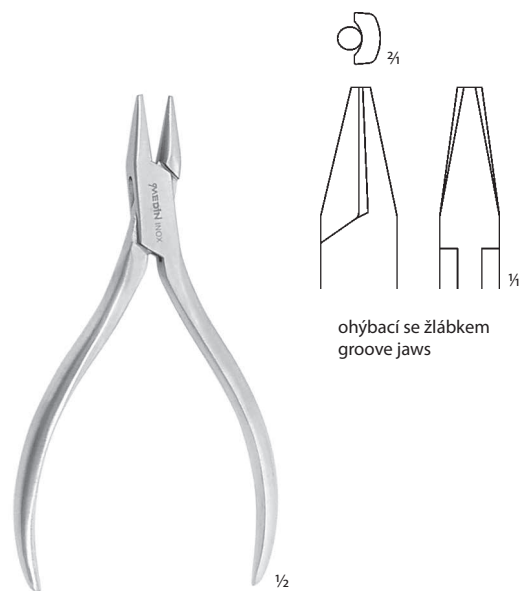

117 52 0860

13,0 cm

pro tvrdý drát do průměru 0,9 mm
for hard wires up to diameter 0,9 mm
Fig. 3



117 52 0880
12,2 cm
pro tvrdý drát do průměru 0,7 mm
for hard wires up to diameter 0,7 mm
Fig. 5

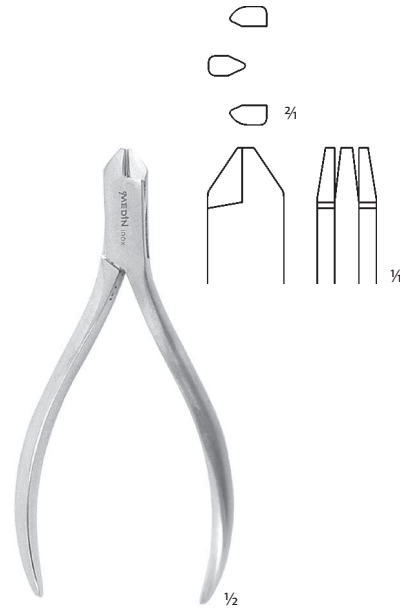

117 52 0890
11,9 cm
pro tvrdý drát do průměru 0,9 mm
for hard wires up to diameter 0,9 mm
Fig. 6

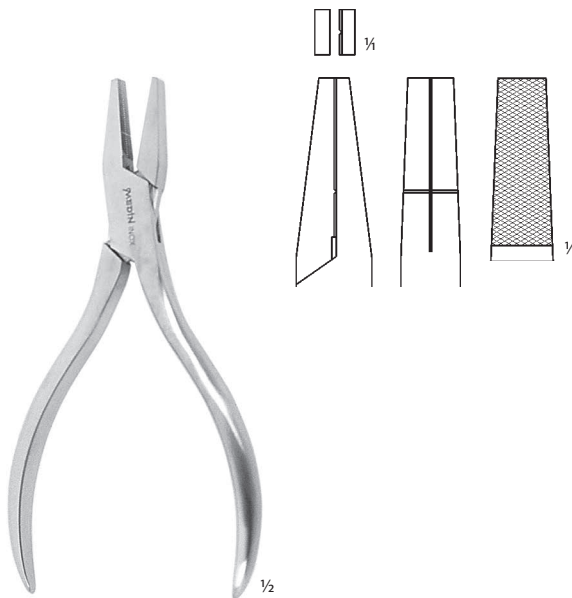

117 52 1000
utahovací
tightening
13,6 cm
pro tvrdý drát do průměru 1,2 mm
for hard wires up to diameter 1,2 mm

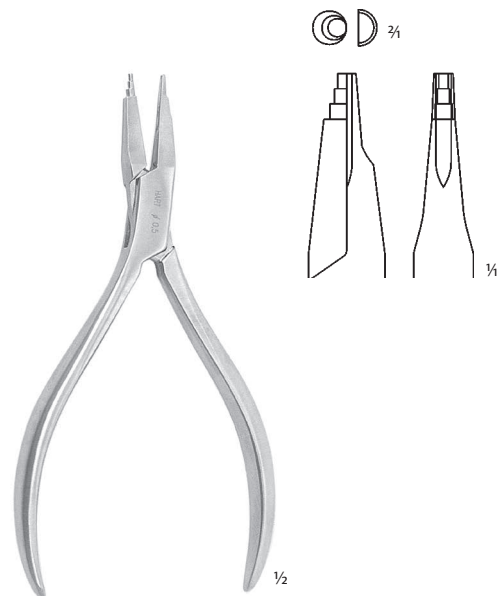

117 52 1010
13,6 cm
pro tvrdý drát do průměru 1,5 mm
for hard wires up to diameter 1,5 mm



Nůž na sádku
Plaster knife
121 52 0050
18,0 cm



Lopatka na sádku
Plaster spatula
121 52 0060
16,8 cm
40/30 mm



Lopatka na míchání
Mixing spatula
121 52 0080
21,0 cm
27 mm

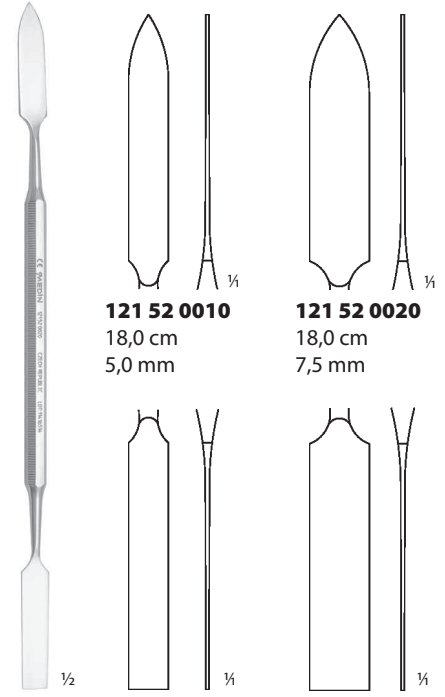

Lopatka na cement
Cement spatula
121 52 0020
18,0 cm

121 52 0010
18,0 cm
5,0 mm

121 52 0020
18,0 cm
7,5 mm

LŽIČKY LABORATORNÍ
LABORATORY SPOONS



125 53 0010
15,0 cm



125 53 0020
20,0 cm

SOUBOR PRO ZUBNÍ TECHNIKY
SET FOR DENTAL TECHNICIANS

1/2

139 50 0360soubor
set**114 50 0011** Pinzeta zubní**115 08 0020** Mosquito-Halsted svorka, zahnutá**117 52 0700** Kleště laboratorní; Fig. 1**121 52 0050** Nůž na sádku**155 52 0180** Le Cron modelovací nástroj**155 52 0212** Nůž modelovací**155 52 0222** Nůž modelovací

Dental forceps

Mosquito-Halsted forceps, bent

Laboratory forceps; Fig. 1

Plaster knife

Le Cron modelling instrument

Modelling knife

Modelling knife

ks / pcs

1

1

1

1

1

1

1

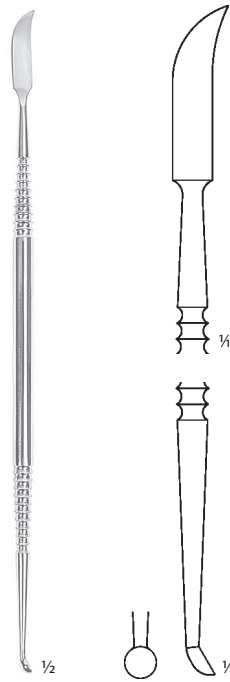

LE CRON
155 52 0180
17,5 cm

NOŽE MODELOVACÍ
MODELLING KNIVES



155 52 0212
13,0 cm



155 52 0222
17,4 cm

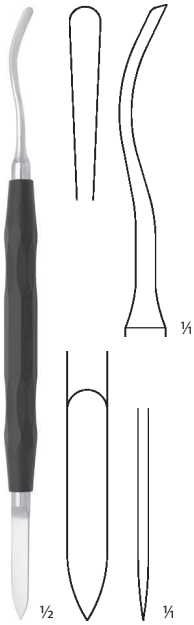

155 52 1442
16,2 cm
Fig. 5

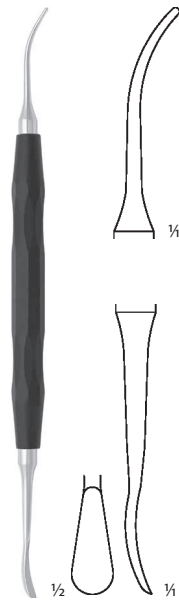

155 52 1462
15,6 cm
Fig. 7

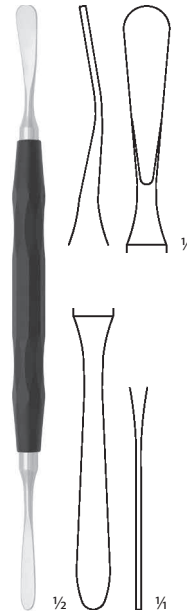

155 52 1472
15,9 cm
Fig. 8



Kladívko laboratorní
Laboratory mallet
128 52 0110
vypouklé, leštěné
convex, polished
26,0 cm



Kladívko laboratorní
Laboratory mallet
128 52 0111
rovné, matované
straight, mat
26,0 cm

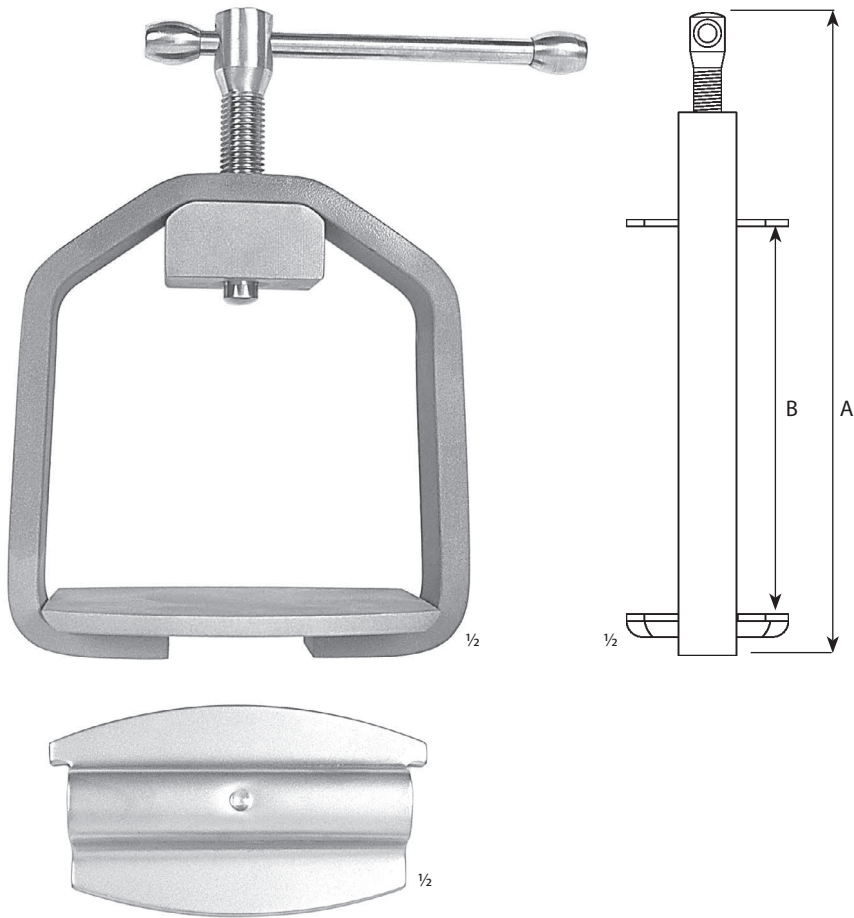

157 52 0030	Třmen pro jednu kyvetu	Clap for one flask	A	B
157 52 0040	Třmen pro dvě kyvety	Clap for two flasks	17,0 cm	6,4 cm
157 52 0050	Třmen pro tři kyvety	Clap for three flasks	22,5 cm	12,0 cm
			28,0 cm	17,5 cm

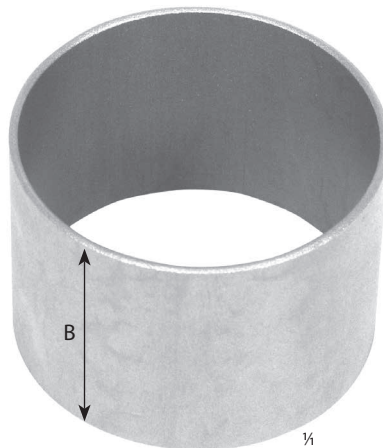

158 99 0023
nerez
stainless steel
5,5 cm

	Ø	B
158 99 0025	3,0 cm	5,5 cm
158 99 0022	3,8 cm	5,5 cm
158 99 0024	6,5 cm	5,5 cm

PODLOŽKA POD LICÍ KROUŽKY
WASHER FOR CASTING RINGS

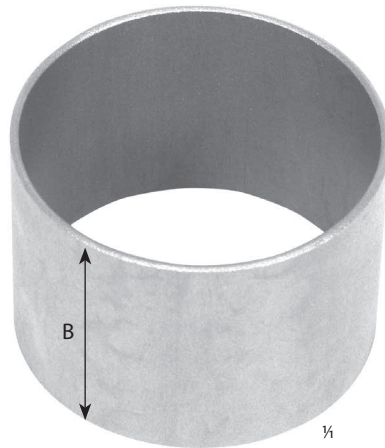

158 91 0001
guma
rubber
Ø 9,0 cm

KROUŽKY KOVOVÉ LICÍ
CASTING RINGS

158 52 0050
nerez
stainless steel
5,5 cm

	Ø	B
158 52 0020	2,8 cm	4,0 cm
158 52 0060	6,0 cm	5,5 cm
158 52 0070	7,0 cm	5,5 cm
158 52 0080	8,0 cm	5,5 cm

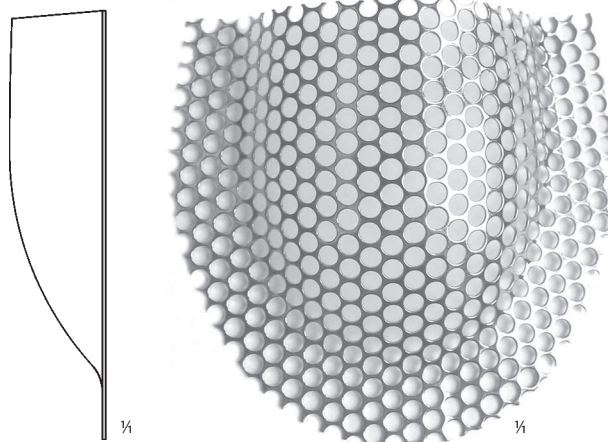
ZESILOVACÍ MŘÍŽKY
MESH STRENGTHENERS

152 52 1900
zlačená
gold plated
60 × 54 × 12 mm

152 52 1910
nerezová
stainless
60 × 54 × 12 mm

OTISKOVACÍ LŽÍCE PRO HORNÍ OZUBENOU ČELIST
IMPRESSION TRAYS FOR TOOTHED UPPER JAWS

s retenčním okrajem
with retentive edge

154 52 9010 H1
154 52 9011 H2
154 52 9012 H3
154 52 9013 H4



s retenčním okrajem, perforované
with retentive edge, perforated

154 52 9018 HX1
154 52 9019 HX2
154 52 9020 HX3
154 52 9021 HX4



perforované
perforated

154 52 0110 BOX1
154 52 0120 BOX2
154 52 0130 BOX3
154 52 0140 BOX4

OTISKOVACÍ LŽÍCE PRO DOLNÍ OZUBENOU ČELIST
IMPRESSION TRAYS FOR TOOTHED LOWER JAWS

s retenčním okrajem
with retentive edge

154 52 9014 D1
154 52 9015 D2
154 52 9016 D3
154 52 9017 D4



s retenčním okrajem, perforované
with retentive edge, perforated

154 52 9022 DX1
154 52 9023 DX2
154 52 9024 DX3
154 52 9025 DX4



perforované
perforated

154 52 0260 FX1
154 52 0270 FX2
154 52 0280 FX3
154 52 0290 FX4

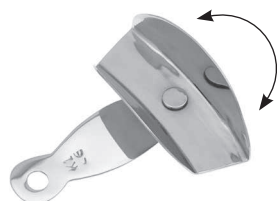
OTISKOVACÍ LŽÍCE
IMPRESSION TRAYS

154 52 0600
korunková
crown



154 52 0560
poloviční levá perforovaná
for partial impressions left perforated
PLX



154 52 0550
poloviční pravá perforovaná
for partial impressions right perforated
PPX

Otiskovací lžice
Impression trays
154 52 1550
soubor
set

154 52 0110	BOX1	1x
154 52 0120	BOX2	1x
154 52 0130	BOX3	1x
154 52 0140	BOX4	1x
154 52 0260	FX1	1x
154 52 0270	FX2	1x
154 52 0280	FX3	1x
154 52 0550	PPX	1x
154 52 0560	PLX	1x

OTISKOVAČÍ LŽÍCE – DĚTSKÉ
IMPRESSION TRAYS – CHILDREN

pro horní čelist, perforovaná
for upper jaws, perforated

154 52 0360 DHX1
154 52 0370 DHX2
154 52 0380 DHX3



pro dolní čelist, perforovaná
for lower jaws, perforated

154 52 0460 DDX1
154 52 0470 DDX2
154 52 0480 DDX3

Otiskovací lžice dětské
Impression trays for children
154 52 1650
soubor
set

154 52 0360	DHX1	1x
154 52 0370	DHX2	1x
154 52 0380	DHX3	1x
154 52 0460	DDX1	1x
154 52 0470	DDX2	1x
154 52 0480	DDX3	1x

OTISKOVAČÍ LŽÍCE PRO BEZZUBOU ČELIST
IMPRESSION TRAYS FOR TOOTHLESS JAWS

horní, perforovaná
upper, perforated

154 52 0610 FOX1
154 52 0620 FOX2
154 52 0630 FOX3
154 52 0640 FOX4



dolní, perforovaná
lower, perforated

154 52 0660 UUX1
154 52 0670 UUX2
154 52 0680 UUX3
154 52 0690 UUX4

OTISKOVAČÍ LŽÍCE PRO ČÁSTEČNĚ OZUBENOU ČELIST
IMPRESSION TRAYS FOR PARTIALLY TOOTHED JAWS

154 52 0790
horní, perforovaná
upper, perforated
BOXC3



154 52 0820
dolní, perforovaná
lower, perforated
FXC2



154 52 0830
dolní, perforovaná
lower, perforated
FXC3



STERILIZACE A POMOCNÉ VYBAVENÍ

STERILIZATION AND ACCESSORIES



Nádobky	Boxes	133
Držátka ubrousku	Napkin Holders	133
Toulce	Quivers	134
Kazety, nádobky	Cassettes, Bowls	135
Krabičky	Boxes	135–137
Tácky	Trays	137
Bubny sterilizační	Sterilization Drums	138–139
Sterilizační kontejnery	Containers for Sterilization	140–144



Nádobka na vatu s pružinou
Cotton wool box with spring
159 53 0050
7,5 cm
Ø 5,0 cm



Nádobka na vatové odpady
Cotton wool bin
159 53 0060
6,5 cm
Ø 5,0 cm

DRŽÁTKA UBROUSKU
NAPKIN HOLDERS



Držátko ubrousku řetizkové
Napkin holder with metal chain
159 53 0100
celková délka 50,0 cm
total length 50,0 cm
kovové svorky
metal clips

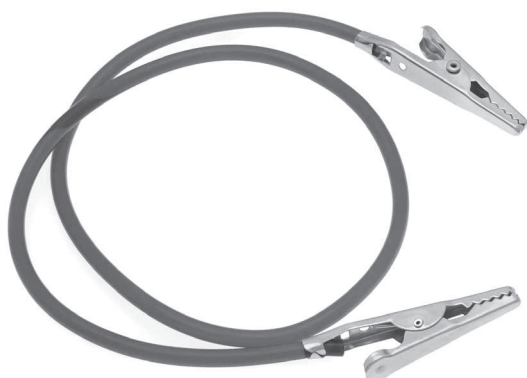

Držátko ubrousku uh
Napkin holder
159 53 0110
celková délka 50,0 cm
total length 50,0 cm
kovové svorky Aligátor
metal clips Aligator



Držátko ubrousku řetizkové
Napkin holder with metal chain
159 53 0120
celková délka 32,0 cm
total length 32,0 cm
kovové svorky Aligátor
metal clips Aligator



136 39 0010
4,7×9,0 cm
na pinzety, leštěný
for tweezers, polished



136 39 0020
6,6×20,0 cm
na podávkové kleště, leštěný
for forceps, polished



136 39 0030
4,3×9,0 cm
na pinzety, matovaný
for tweezers, mat



136 39 0040
7,0×20,0 cm
na podávkové kleště, matovaný
for forceps, mat

TOULCE S PODSTAVCEM QUIVERS WITH STAND



136 39 0050
70×110 mm
na pinzety
for tweezers



136 39 0060
70×200 mm
na kleště
for forceps



136 39 0070
50×90 mm
na pinzety
for tweezers

KAZETA S DRŽÁKEM
CASSETTE WITH HOLDER

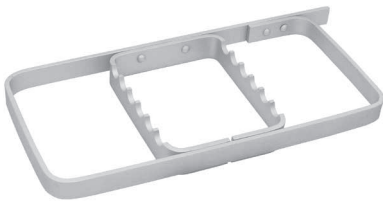

Držák
Holder
139 50 0150
aluminium
21,0 × 9,6 × 1,6 cm



Kazeta s držákem
Cassette with holder
139 50 0160
aluminium
22,0 × 10,5 × 3,6 cm



Kazeta
Cassette
139 50 0170
aluminium
22,0 × 10,5 × 3,6 cm

NÁDOBKY
BOWLS



136 39 0260
nerez – stainless steel
175×100×25 mm



136 39 0270
nerez – stainless steel
90×40 mm



136 39 0320
nerez – stainless steel
82×30 mm

KRABÍČKY KULATÉ
BOXES ROUND



136 39 0213 40 × 13 mm
136 39 0211 65 × 15 mm
136 39 0214 80 × 18 mm
136 39 0215 90 × 20 mm
136 39 0216 100 × 20 mm
nerez – stainless steel



Krabička perforovaná
Box round
136 39 0212
nerez – stainless steel
62×13 mm



136 39 0140
nerez – stainless steel
200×100×30 mm



136 39 0150
nerez – stainless steel
170×70×30 mm



136 39 0160
nerez – stainless steel
200×100×40 mm



136 39 0170
nerez – stainless steel
210×115×45 mm



136 39 0180
nerez – stainless steel
dvojití víčko – double lid
210×110×25 mm



136 39 0190
nerez – stainless steel
210×115×45 mm



136 39 0200
nerez – stainless steel
na katetry – for catheters
300×80×40 mm



136 39 0220
nerez – stainless steel
350×90×50 mm



136 39 0230
nerez – stainless steel
230×150×60 mm



136 39 0240
nerez – stainless steel
300×200×50 mm



136 39 0250
nerez – stainless steel
200×150×45 mm

POZNÁMKY: vnitřní rozměry
NOTES: inner dimensions

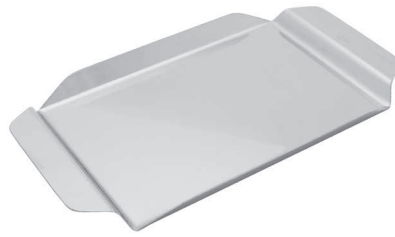

136 39 0110
nerez – stainless steel
180×120×15 mm



136 39 0330
nerez – stainless steel
200×100×10 mm



136 39 0340
nerez – stainless steel
180×90×15 mm



136 39 0350
nerez – stainless steel
200×100×30 mm



136 39 0360
nerez – stainless steel
190×100×10 mm



136 39 0370
nerez – stainless steel
280×180×25 mm



136 39 0380
nerez – stainless steel
350×250×25 mm

POZNÁMKY: vnitřní rozměry
NOTES: inner dimensions



136 39 0210
nerez – stainless steel
92×40×17 mm



136 39 0410
plast – plastic
na umělý chrup – for denture
80×80×40 mm

BUBNY STERILIZAČNÍ PRO HORKOVZDUŠNOU STERILIZACI
STERILIZATION DRUMS FOR DRY-HEAT STERILIZATIONBuben sterilizační
Sterilization drum

136 91 1314	125×80 mm	136 91 1342	290×190 mm
136 91 1315	125×100 mm	136 91 1343	290×240 mm
136 91 1316	125×125 mm	136 91 1344	290×290 mm
136 91 1317	150×80 mm	136 91 1345	290×340 mm
136 91 1318	150×100 mm	136 91 1346	290×390 mm
136 91 1319	150×130 mm	136 91 1347	340×120 mm
136 91 1320	150×150 mm	136 91 1348	340×145 mm
136 91 1321	150×190 mm	136 91 1349	340×165 mm
136 91 1322	150×240 mm	136 91 1350	340×190 mm
136 91 1323	190×95 mm	136 91 1351	340×240 mm
136 91 1324	190×125 mm	136 91 1352	340×290 mm
136 91 1325	190×145 mm	136 91 1353	340×340 mm
136 91 1326	190×165 mm	136 91 1354	340×390 mm
136 91 1327	190×190 mm	136 91 1355	390×140 mm
136 91 1328	190×240 mm	136 91 1356	390×165 mm
136 91 1329	190×290 mm	136 91 1357	390×190 mm
136 91 1330	240×95 mm	136 91 1358	390×240 mm
136 91 1331	240×120 mm	136 91 1359	390×290 mm
136 91 1332	240×145 mm	136 91 1360	390×340 mm
136 91 1333	240×165 mm	136 91 1361	390×390 mm
136 91 1334	240×190 mm	136 91 1362	390×490 mm
136 91 1335	240×240 mm	136 91 1363	390×590 mm
136 91 1336	240×290 mm	136 91 1364	480×165 mm
136 91 1337	240×340 mm	136 91 1365	480×190 mm
136 91 1338	240×390 mm	136 91 1366	480×240 mm
136 91 1339	290×120 mm	136 91 1367	480×290 mm
136 91 1340	290×145 mm	136 91 1368	480×340 mm
136 91 1341	290×165 mm	136 91 1369	480×390 mm

BUBNY STERILIZAČNÍ PRO PARNÍ STERILIZACI
 STERILIZATION DRUMS FOR STEAM STERILIZATION

 Buben sterilizační
 Sterilization drum

136 91 1275	125×80 mm	136 91 1295	290×120 mm
136 91 1276	125×100 mm	136 91 1296	290×145 mm
136 91 1277	125×125 mm	136 91 1297	290×165 mm
136 91 1278	150×100 mm	136 91 1298	290×190 mm
136 91 1279	150×130 mm	136 91 1299	290×240 mm
136 91 1280	150×150 mm	136 91 1300	290×290 mm
136 91 1281	150×190 mm	136 91 1301	340×120 mm
136 91 1282	150×240 mm	136 91 1302	340×145 mm
136 91 1283	190×95 mm	136 91 1303	340×165 mm
136 91 1284	190×125 mm	136 91 1304	340×190 mm
136 91 1285	190×145 mm	136 91 1305	340×240 mm
136 91 1286	190×165 mm	136 91 1306	340×290 mm
136 91 1287	190×190 mm	136 91 1307	390×140 mm
136 91 1288	190×240 mm	136 91 1308	390×165 mm
136 91 1289	190×290 mm	136 91 1309	390×190 mm
136 91 1290	240×120 mm	136 91 1310	390×240 mm
136 91 1291	240×165 mm	136 91 1311	390×290 mm
136 91 1292	240×190 mm	136 91 1312	390×340 mm
136 91 1293	240×240 mm	136 91 1313	390×390 mm
136 91 1294	240×290 mm		

 POZNÁMKY: vnější rozměry
 NOTES: outer dimensions

FILTRY PRO BUBNY STERILIZAČNÍ
 FILTERS FOR STERILIZATION DRUMS

	pro rozměr	materiál	balení	počet sterilizací	model	material	packing	sterilization processes	
136 91 1390	Ø 85	125; 150	textil	1 ks	70 (max.)	125; 150	textile	1 pcs	70 (max.)
136 91 1391	Ø 100	190	textil	1 ks	70 (max.)	190	textile	1 pcs	70 (max.)
136 91 1392	Ø 140	240	textil	1 ks	70 (max.)	240	textile	1 pcs	70 (max.)
136 91 1393	Ø 180	290	textil	1 ks	70 (max.)	290	textile	1 pcs	70 (max.)
136 91 1394	Ø 225	340	textil	1 ks	70 (max.)	340	textile	1 pcs	70 (max.)
136 91 1395	Ø 270	390×140	textil	1 ks	70 (max.)	390×140	textile	1 pcs	70 (max.)
136 91 1396	Ø 310	>390×165	textil	1 ks	70 (max.)	>390×165	textile	1 pcs	70 (max.)

KONTEJNERY, VELIKOST 1/2
CONTAINERS, SIZE 1/2

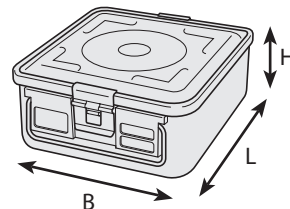

Kontejnery – Containers



barevná pouze víka
lid colored only

L	B	H						
285 × 280 × 100 mm			136 91 0259	136 91 0260	136 91 0261	136 91 0262	136 91 0263	136 91 0264
285 × 280 × 135 mm			136 91 0265	136 91 0266	136 91 0267	136 91 0268	136 91 0269	136 91 0270
285 × 280 × 150 mm			136 91 0271	136 91 0272	136 91 0273	136 91 0274	136 91 0275	136 91 0276
285 × 280 × 200 mm			136 91 0277	136 91 0278	136 91 0279	136 91 0280	136 91 0281	136 91 0282
285 × 280 × 260 mm			136 91 0283	136 91 0284	136 91 0285	136 91 0286	136 91 0287	136 91 0288



barevná pouze víka
lid colored only

285 × 280 × 110 mm			136 91 0337	136 91 0338	136 91 0339	136 91 0340	136 91 0341	136 91 0342
285 × 280 × 135 mm			136 91 0343	136 91 0344	136 91 0345	136 91 0346	136 91 0347	136 91 0348
285 × 280 × 150 mm			136 91 0349	136 91 0350	136 91 0351	136 91 0352	136 91 0353	136 91 0354
285 × 280 × 200 mm			136 91 0355	136 91 0356	136 91 0357	136 91 0358	136 91 0359	136 91 0360
285 × 280 × 260 mm			136 91 0361	136 91 0362	136 91 0363	136 91 0364	136 91 0365	136 91 0366

Víka – Lids



L	B							
285 × 280 mm			136 91 0415	136 91 0416	136 91 0417	136 91 0418	136 91 0419	136 91 0420
285 × 280 mm			136 91 0438	136 91 0439	136 91 0440	136 91 0441	136 91 0442	136 91 0443
285 × 280 mm			136 91 0490	136 91 0491	136 91 0492	136 91 0493	136 91 0494	136 91 0495

Vany – Bottoms



barevná pouze víka
lid colored only

L	B	H	
285 × 280 × 100 mm			136 91 0463
285 × 280 × 135 mm			136 91 0464
285 × 280 × 150 mm			136 91 0465
285 × 280 × 200 mm			136 91 0466
285 × 280 × 260 mm			136 91 0467



barevná pouze víka
lid colored only

285 × 280 × 100 mm			136 91 0475
285 × 280 × 135 mm			136 91 0476
285 × 280 × 150 mm			136 91 0477
285 × 280 × 200 mm			136 91 0478
285 × 280 × 260 mm			136 91 0479

Koš – Basket



L	B	H	
255 × 245 × 30 mm			136 91 0526
255 × 245 × 50 mm			136 91 0527
255 × 245 × 70 mm			136 91 0528
255 × 245 × 100 mm			136 91 0529

Síto – Divider



L	B	H	
255 × 245 × 130 mm			136 91 0675

Rámy – Retainers



L	B	H	
255 × 255 mm			136 91 0667
255 × 255 × 30 mm			136 91 0668

POZNÁMKY: u kontejnerů jsou uvedeny vnitřní rozměry
NOTES: for containers are specified internal dimensions

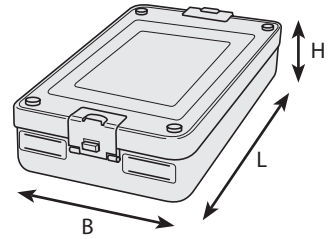

Kontejnery – Containers



barevná pouze víka
lid colored only

L	B	H						
310 × 190 × 50 mm			136 91 0696	136 91 0697	136 91 0698	136 91 0699	136 91 0700	136 91 0701
310 × 190 × 65 mm			136 91 0702	136 91 0703	136 91 0704	136 91 0705	136 91 0706	136 91 0707
310 × 190 × 130 mm			136 91 0708	136 91 0709	136 91 0710	136 91 0711	136 91 0712	136 91 0713



barevná pouze víka
lid colored only

310 × 190 × 50 mm			136 91 0714	136 91 0715	136 91 0716	136 91 0717	136 91 0718	136 91 0719
310 × 190 × 65 mm			136 91 0720	136 91 0721	136 91 0722	136 91 0723	136 91 0724	136 91 0725
310 × 190 × 130 mm			136 91 0726	136 91 0727	136 91 0728	136 91 0729	136 91 0730	136 91 0731

Víka – Lids



L	B							
310 × 190 mm			136 91 0645	136 91 0646	136 91 0647	136 91 0648	136 91 0649	136 91 0650
310 × 190 mm			136 91 0653	136 91 0654	136 91 0655	136 91 0656	136 91 0657	136 91 0658

Vany – Bottoms



barevná pouze víka
lid colored only

L	B	H	
310 × 190 × 50 mm			136 91 0690
310 × 190 × 65 mm			136 91 0691
310 × 190 × 130 mm			136 91 0692

Koš – Basket



L	B	H	
274 × 172 × 43 mm			136 91 0662

Rám – Retainer



L	B	
310 × 190 × 50 mm		136 91 0693
310 × 190 × 65 mm		136 91 0694
310 × 190 × 130 mm		136 91 0695
270 × 170 mm		136 91 0669

barevná pouze víka
lid colored only

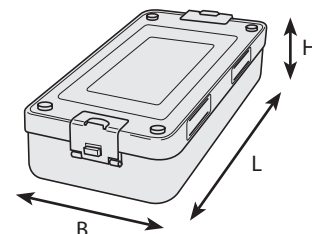
KONTEJNERY MINI
SMALL CONTAINERS

Kontejnery – Containers

L	B	H						
300 × 140 × 40 mm			136 91 0569	136 91 0570	136 91 0571	136 91 0572	136 91 0573	136 91 0684
300 × 140 × 70 mm			136 91 0574	136 91 0575	136 91 0576	136 91 0577	136 91 0578	136 91 0685
300 × 140 × 100 mm			136 91 0579	136 91 0580	136 91 0581	136 91 0582	136 91 0583	136 91 0686

barevná pouze víka
lid colored only

300 × 140 × 40 mm			136 91 0584	136 91 0585	136 91 0586	136 91 0587	136 91 0588	136 91 0687
300 × 140 × 70 mm			136 91 0589	136 91 0590	136 91 0591	136 91 0592	136 91 0593	136 91 0688
300 × 140 × 100 mm			136 91 0594	136 91 0595	136 91 0596	136 91 0597	136 91 0598	136 91 0689

barevná pouze víka
lid colored only

Víka – Lids

L	B							
300 × 140 mm			136 91 0485	136 91 0486	136 91 0487	136 91 0488	136 91 0489	136 91 0652
300 × 140 mm			136 91 0513	136 91 0514	136 91 0515	136 91 0516	136 91 0517	136 91 0659



Vany – Bottoms

L	B	H	
300 × 140 × 40 mm			136 91 0599
300 × 140 × 70 mm			136 91 0600
300 × 140 × 100 mm			136 91 0601

barevná pouze víka
lid colored only

300 × 140 × 40 mm			136 91 0602
300 × 140 × 70 mm			136 91 0603
300 × 140 × 100 mm			136 91 0604

barevná pouze víka
lid colored only

Koš – Basket



L	B	H	
267 × 125 × 50 mm			136 91 0661

Síto – Divider



L	B	
270 × 125 mm		136 91 0660

Rám – Retainer



L	B	
270 × 155 mm		136 91 0670

POZNÁMKY: u kontejnerů jsou uvedeny vnitřní rozměry
NOTES: for containers are specified internal dimensions

PŘÍSLUŠENSTVÍ PRO STERILIZAČNÍ KONTEJNERY
 ACCESSORIES FOR CONTAINERS FOR STERILIZATION

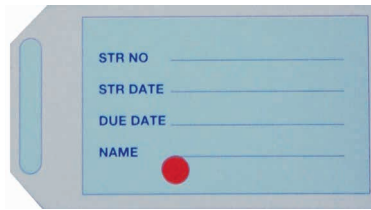
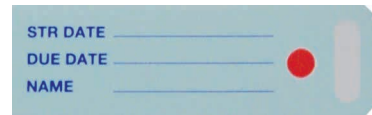
ŠTÍTKY IDENTIFIKAČNÍ PAPIROVÉ
 PAPER LABELS WITH INDICATOR

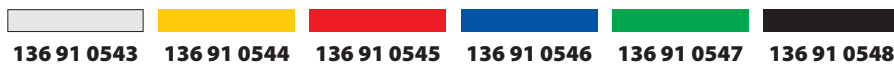
136 91 0540
 standard – standard
 100 ks/pcs

136 91 0541
 malý – small
 100 ks/pcs

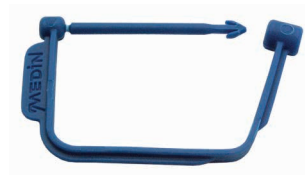
ŠTÍTKY IDENTIFIKAČNÍ
 IDENTIFICATION LABELS

136 91 0543 **136 91 0544** **136 91 0545** **136 91 0546** **136 91 0547** **136 91 0548**
ŠTÍTKY IDENTIFIKAČNÍ HLINÍKOVÉ PRO TEXT
 IDENTIFICATION ALUMINIUM LABELS ENGRAVE

136 91 0550 **136 91 0551** **136 91 0552** **136 91 0553** **136 91 0554** **136 91 0555**
ZÁMEK BEZPEČNOSTNÍ PLASTOVÝ, PLOMBA PRO STERILIZAČNÍ KONTEJNERY
 PLASTIC SECURITY SEAL, SEAL FOR STERILIZING CONTAINERS

136 91 0542
 100 ks/pcs

285 499 54 7000
 100 ks/pcs

FILTRY
 FILTERS

		typ	materiál	balení	počet sterilizací	model	material	packing	sterilization processes
136 91 0534	Ø 190 mm	standard	papír	100 ks	1	standard	paper	100 pcs	1
136 91 0535	Ø 190 mm	standard	textil	1 ks	50 (max.)	standard	textile	1 pcs	50 (max.)
136 91 0635	Ø 190 mm	standard	teflon	1 ks	2000 (max.)	standard	teflon	1 pcs	2000 (max.)



136 91 0536	235×180 mm	mini	papír	100 ks	1	small	paper	100 pcs	1
136 91 0537	235×180 mm	mini	textil	1 ks	50 (max.)	small	textile	1 pcs	50 (max.)
136 91 0743	235×180 mm	mini	teflon	1 ks	2000 (max.)	small	teflon	1 pcs	2000 (max.)



136 91 0676	230×170 mm	dentální	papír	100 ks	1	dental	paper	100 pcs	1
136 91 0677	230×170 mm	dentální	textil	1 ks	50 (max.)	dental	textile	1 pcs	50 (max.)

PŘÍSLUŠENSTVÍ PRO STERILIZAČNÍ KONTEJNERY
 ACCESSORIES FOR CONTAINERS FOR STERILIZATION

ROUŠKY, PODLOŽKY
 CLOTHS, MATS

 Roušky textilní, zelené
 Green cloths

60 × 40 cm	136 91 0619
85 × 85 cm	136 91 0620
100 × 140 cm	136 91 0621
275 × 125 cm	136 91 0622
245 × 245 cm	136 91 0623

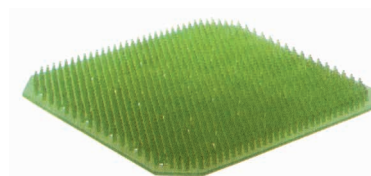
 Podložky silikonové
 Silicon mats

275 × 125 mm	136 91 0624
225 × 225 mm	136 91 0625
300 × 300 mm	136 91 0626
440 × 230 mm	136 91 0630
500 × 210 mm	136 91 1389

STERILIZAČNÍ KONTEJNERY A PŘÍSLUŠENSTVÍ
 CONTAINERS FOR STERILIZATION AND ACCESSORIES

Kompletní nabídku sterilizačních kontejnerů a příslušenství naleznete v katalogu STERILIZAČNÍ KONTEJNERY.

All of the range of containers for sterilization and accessories can be found in catalogue of CONTAINERS FOR STERILIZATION.

www.medin.cz

Katalog je dostupný na internetových stránkách MEDIN, a.s.
Tiskovou verzi katalogu si můžete vyžádat u našich obchodních zástupců.

The catalogue is available for download on our MEDIN, a.s., web sites.
Printed version is on request at our Sales Representatives.

číslo – number	název	item	strana – page
112	Nástroje řezné	Cutting Instruments	
112 38 0010	Dieffenbach skalpel oční bříškatý; 1,7 cm, fig. 1	Dieffenbach knife; 1,7 cm, fig. 1	41
112 38 0020	Dieffenbach skalpel oční bříškatý; 2,0 cm, fig. 2	Dieffenbach knife; 2,0 cm, fig. 2	41
112 38 0030	Dieffenbach skalpel oční bříškatý; 2,5 cm, fig. 4	Dieffenbach knife; 2,5 cm, fig. 4	41
112 38 0040	Dieffenbach skalpel oční bříškatý; 3,0 cm, fig. 5	Dieffenbach knife; 3,0 cm, fig. 5	41
112 38 0110	Dieffenbach skalpel oční hrotnatý; 1,7 cm, fig. 7	Dieffenbach knife; 1,7 cm, fig. 7	41
112 38 0120	Dieffenbach skalpel oční hrotnatý; 2,0 cm, fig. 8	Dieffenbach knife; 2,0 cm, fig. 8	41
112 38 0130	Dieffenbach skalpel oční hrotnatý; 2,5 cm, fig. 9	Dieffenbach knife; 2,5 cm, fig. 9	41
112 38 0140	Dieffenbach skalpel oční hrotnatý; 3,0 cm, fig. 10	Dieffenbach knife; 3,0 cm, fig. 10	41
112 50 0050	Nůž na dáseň oboustranný; 18,0 cm	Gum knife mutual; 18,0 cm	40
112 50 0060	Nůž na gingivektomii fig. 1; 17,3 cm	Gingivectomy knife fig. 1; 17,3 cm	40
112 50 0070	Nůž na gingivektomii fig. 2; 17,3 cm	Gingivectomy knife fig. 2; 17,3 cm	40
112 91 0002	Držátko skalpelových čepelek s měřítkem; fig. 3	Scalpel handle with scale fig. 3	42
112 91 0003	Držátko skalpelových čepelek; fig. 3	Scalpel handle fig. 3	42
112 91 0004	Držátko skalpelových čepelek; fig. 4	Scalpel handle fig. 4	42, 125
112 91 0005	Držátko skalpelových čepelek; fig. 3l	Scalpel handle fig. 3l	42
112 91 0010	Čepelka skalpelová; fig. 10 (baleno po 100 ks)	Scalpel blades fig. 10 (pck=100 pcs)	43
112 91 0011	Čepelka skalpelová; fig. 11 (baleno po 100 ks)	Scalpel blades fig. 11 (pck=100 pcs)	43
112 91 0012	Čepelka skalpelová; fig. 12 (baleno po 100 ks)	Scalpel blades fig. 12 (pck=100 pcs)	43
112 91 0013	Čepelka skalpelová; fig. 13 (baleno po 100 ks)	Scalpel blades fig. 13 (pck=100 pcs)	43
112 91 0015	Čepelka skalpelová; fig. 15 (baleno po 100 ks)	Scalpel blades fig. 15 (pck=100 pcs)	43
112 91 0018	Čepelka skalpelová; fig. 18 (baleno po 100 ks)	Scalpel blades fig. 18 (pck=100 pcs)	43
112 91 0020	Čepelka skalpelová; fig. 20 (baleno po 100 ks)	Scalpel blades fig. 20 (pck=100 pcs)	43
112 91 0021	Čepelka skalpelová; fig. 21 (baleno po 100 ks)	Scalpel blades fig. 21 (pck=100 pcs)	43
112 91 0022	Čepelka skalpelová; fig. 22 (baleno po 100 ks)	Scalpel blades fig. 22 (pck=100 pcs)	43
112 91 0023	Čepelka skalpelová; fig. 23 (baleno po 100 ks)	Scalpel blades fig. 23 (pck=100 pcs)	43
112 91 0024	Čepelka skalpelová; fig. 24 (baleno po 100 ks)	Scalpel blades fig. 24 (pck=100 pcs)	43
112 91 0025	Čepelka skalpelová; fig. 12d (baleno po 100 ks)	Scalpel blades fig. 12d (pck=100 pcs)	43
112 91 0026	Čepelka skalpelová; fig. 15c (baleno po 100 ks)	Scalpel blades fig. 15c (pck=100 pcs)	43
112 91 0027	Čepelka skalpelová; fig. 25 (baleno po 100 ks)	Scalpel blades fig. 25 (pck=100 pcs)	43
113	Nůžky	Scissors	
113 05 0030	Lister nůžky na obvazy; 15,0 cm	Lister bandage scissors; 15,0 cm	55
113 05 0040	Lister nůžky na obvazy; 20,0 cm	Lister bandage scissors; 20,0 cm	55
113 08 0010	Standard nůžky chirurgické rovné; 13,0 cm	Standard operating scissors; 13,0 cm	58
113 08 0020	Standard nůžky chirurgické rovné; 15,0 cm	Standard operating scissors; 15,0 cm	58
113 08 0040	Standard nůžky chirurgické rovné; 18,5 cm	Standard operating scissors; 18,5 cm	58
113 08 0060	Standard nůžky chirurgické rovné; 22,0 cm	Standard operating scissors; 22,0 cm	58
113 08 0070	Standard nůžky chirurgické rovné; 30,0 cm	Standard operating scissors; 30,0 cm	58
113 08 0110	Standard nůžky chirurgické rovné; 13,0 cm	Standard operating scissors; 13,0 cm	58
113 08 0120	Standard nůžky chirurgické rovné; 15,0 cm	Standard operating scissors; 15,0 cm	58
113 08 0140	Standard nůžky chirurgické rovné; 18,5 cm	Standard operating scissors; 18,5 cm	58
113 08 0160	Standard nůžky chirurgické rovné; 22,0 cm	Standard operating scissors; 22,0 cm	58
113 08 0170	Standard nůžky chirurgické rovné; 30,0 cm	Standard operating scissors; 30,0 cm	58
113 08 0210	Standard nůžky chirurgické rovné; 13,0 cm	Standard operating scissors; 13,0 cm	58
113 08 0220	Standard nůžky chirurgické rovné; 15,0 cm	Standard operating scissors; 15,0 cm	58
113 08 0240	Standard nůžky chirurgické rovné; 18,5 cm	Standard operating scissors; 18,5 cm	58
113 08 0260	Standard nůžky chirurgické rovné; 22,0 cm	Standard operating scissors; 22,0 cm	58
113 08 0270	Standard nůžky chirurgické rovné; 30,0 cm	Standard operating scissors; 30,0 cm	58
113 08 0310	Standard nůžky chirurgické zahnuté; 13,0 cm	Standard operating scissors; 13,0 cm	58
113 08 0320	Standard nůžky chirurgické zahnuté; 15,0 cm	Standard operating scissors; 15,0 cm	58
113 08 0340	Standard nůžky chirurgické zahnuté; 18,5 cm	Standard operating scissors; 18,5 cm	58
113 08 0360	Standard nůžky chirurgické zahnuté; 22,0 cm	Standard operating scissors; 22,0 cm	58
113 08 0370	Standard nůžky chirurgické zahnuté; 30,0 cm	Standard operating scissors; 30,0 cm	58
113 08 0410	Standard nůžky chirurgické zahnuté; 13,0 cm	Standard operating scissors; 13,0 cm	58
113 08 0420	Standard nůžky chirurgické zahnuté; 15,0 cm	Standard operating scissors; 15,0 cm	58
113 08 0440	Standard nůžky chirurgické zahnuté; 18,5 cm	Standard operating scissors; 18,5 cm	58
113 08 0460	Standard nůžky chirurgické zahnuté; 22,0 cm	Standard operating scissors; 22,0 cm	58
113 08 0470	Standard nůžky chirurgické zahnuté; 30,0 cm	Standard operating scissors; 30,0 cm	58
113 08 0510	Standard nůžky chirurgické zahnuté; 13,0 cm	Standard operating scissors; 13,0 cm	58
113 08 0520	Standard nůžky chirurgické zahnuté; 15,0 cm	Standard operating scissors; 15,0 cm	58
113 08 0540	Standard nůžky chirurgické zahnuté; 18,5 cm	Standard operating scissors; 18,5 cm	58
113 08 0560	Standard nůžky chirurgické zahnuté; 22,0 cm	Standard operating scissors; 22,0 cm	58
113 08 0570	Standard nůžky chirurgické zahnuté; 30,0 cm	Standard operating scissors; 30,0 cm	58

číslo – number	název	item	strana – page
113 38 0010	Nůžky rovné; 10,0 cm	Scissors straight; 10,0 cm	61
113 38 0020	Nůžky rovné; 10,0 cm	Scissors straight; 10,0 cm	61
113 38 0030	Nůžky rovné; 10,0 cm	Scissors straight; 10,0 cm	61
113 38 0040	Nůžky zahnuté; 10,0 cm	Scissors curved; 10,0 cm	61
113 38 0050	Nůžky zahnuté; 10,0 cm	Scissors curved; 10,0 cm	61
113 38 0060	Nůžky zahnuté; 10,0 cm	Scissors curved; 10,0 cm	61
113 38 0071	Nůžky rovné; 11,5 cm	Scissors straight; 11,5 cm	61
113 38 0081	Nůžky rovné; 11,5 cm	Scissors straight; 11,5 cm	61
113 38 0091	Nůžky zahnuté; 11,5 cm	Scissors curved; 11,5 cm	61
113 38 0100	Nůžky zahnuté; 11,5 cm	Scissors curved; 11,5 cm	61
113 38 0150	Nůžky rovné; 11,5 cm	Scissors straight; 11,5 cm	61
113 38 0161	Nůžky zahnuté; 11,5 cm	Scissors curved; 11,5 cm	61
113 38 0210	Nůžky lomené; 10,5 cm	Scissors angled; 10,5 cm	61
113 38 0260	Nůžky lomené; 10,5 cm	Scissors angled; 10,5 cm	61
113 38 0311	Nůžky; 11,5 cm	Scissors; 11,5 cm	61
113 38 1020	Castroviejo nůžky oční zahnuté; 9,0 cm	Castroviejo eye scissors; 9,0 cm	62
113 38 1030	Castroviejo nůžky oční lomené; 9,0 cm	Castroviejo eye scissors; 9,0 cm	62
113 50 0010	Nůžky na dásěň rovné; 12,0 cm	Gum scissors; 12,0 cm	56
113 50 0020	Nůžky na dásěň zahnuté; 12,0 cm	Gum scissors; 12,0 cm	56
113 50 0030	Nůžky na dásěň rovné; 14,5 cm	Gum scissors; 14,5 cm	56
113 50 0040	Nůžky na dásěň zahnuté; 14,5 cm	Gum scissors; 14,5 cm	56
113 52 0150	Nůžky na korunky rovné; 11,0 cm	Crown scissors; 11,0 cm	116
113 52 0160	Nůžky na korunky zahnuté; 11,0 cm	Crown scissors; 11,0 cm	116
113 91 0002	Standard nůžky chirurgické rovné; 11,5 cm	Standard operating scissors; 11,5 cm	59
113 91 0006	Standard nůžky chirurgické rovné; 16,5 cm	Standard operating scissors; 16,5 cm	59
113 91 0009	Standard nůžky chirurgické rovné; 20,0 cm	Standard operating scissors; 20,0 cm	59
113 91 0011	Standard nůžky chirurgické zahnuté; 11,5 cm	Standard operating scissors; 11,5 cm	59
113 91 0015	Standard nůžky chirurgické zahnuté; 16,5 cm	Standard operating scissors; 16,5 cm	59
113 91 0018	Standard nůžky chirurgické zahnuté; 20,0 cm	Standard operating scissors; 20,0 cm	59
113 91 0020	Nůžky chirurgické rovné; 11,5 cm	Operating scissors; 11,5 cm	59
113 91 0026	Nůžky chirurgické rovné; 16,5 cm	Operating scissors; 16,5 cm	59
113 91 0029	Nůžky chirurgické rovné; 20,0 cm	Operating scissors; 20,0 cm	59
113 91 0031	Nůžky chirurgické zahnuté; 11,5 cm	Operating scissors; 11,5 cm	59
113 91 0037	Nůžky chirurgické zahnuté; 16,5 cm	Operating scissors; 16,5 cm	59
113 91 0040	Nůžky chirurgické zahnuté; 20,0 cm	Operating scissors; 20,0 cm	59
113 91 0042	Nůžky chirurgické rovné; 11,5 cm	Operating scissors; 11,5 cm	59
113 91 0046	Nůžky chirurgické rovné; 16,5 cm	Operating scissors; 16,5 cm	59
113 91 0049	Nůžky chirurgické rovné; 20,0 cm	Operating scissors; 20,0 cm	59
113 91 0051	Nůžky chirurgické zahnuté; 11,5 cm	Operating scissors; 11,5 cm	59
113 91 0055	Nůžky chirurgické zahnuté; 16,5 cm	Operating scissors; 16,5 cm	59
113 91 0058	Nůžky chirurgické zahnuté; 20,0 cm	Operating scissors; 20,0 cm	59
113 91 0221	Sanvenero nůžky preparační hrotnaté rovné; 14,0 cm	Sanvenero dissecting scissors; 14,0 cm	57
113 91 0222	Sanvenero nůžky preparační hrotnaté zahnuté; 14,0 cm	Sanvenero dissecting scissors; 14,0 cm	57
113 91 0233	Reynolds nůžky preparační ostré rovné; 15,0 cm	Reynolds dissecting scissors; 15,0 cm	57
113 91 0235	Reynolds nůžky preparační ostré zahnuté; 15,0 cm	Reynolds dissecting scissors; 15,0 cm	57
113 91 0328	Wagner nůžky jemné hrotnaté rovné; 12,0 cm	Wagner fine scissors straight; 12,0 cm	60
113 91 0331	Wagner nůžky jemné hrotnaté zahnuté; 12,0 cm	Wagner fine scissors curved; 12,0 cm	60
113 91 0348	Walton nůžky jemné hrotnaté zahnuté; 10,0 cm	Walton fine scissors sharp curved; 10,0 cm	60
113 91 0349	Mod. Bonn nůžky extra jemné rovné; 8,0 cm	Mod. Bonn extra delicate scissors straight; 8,0 cm	60
113 91 0350	Mod. Bonn nůžky extra jemné zahnuté; 8,0 cm	Mod. Bonn extra delicate scissors curved; 8,0 cm	60
113 91 0399	Spencer nůžky pro ligaturu; 9 cm	Spencer ligature scissors; 9,0 cm	57
113 91 0400	Spencer nůžky pro ligaturu; 10,5 cm	Spencer ligature scissors; 10,5 cm	57
113 91 0403	Littauer nůžky pro ligaturu; 14,0 cm	Littauer ligature scissors; 14,0 cm	57
113 91 0474	Goldman-Fox nůžky na dásěň rovné; 13,0 cm	Goldman-Fox scissors; 13,0 cm	56
113 91 0475	Goldman-Fox nůžky na dásěň zahnuté; 13,0 cm	Goldman-Fox scissors; 13,0 cm	56
113 91 0483	Quinby nůžky na dásěň rovné; 12,0 cm	Quinby gum scissors; 12,0 cm	56
113 91 0484	Quinby nůžky na dásěň zahnuté; 12,0 cm	Quinby gum scissors; 12,0 cm	56
113 91 0490	Noyes nůžky na duhovku hrotnaté rovné; 12,0 cm	Noyes iris scissors; 12,0 cm	62
113 91 0492	Noyes nůžky na duhovku hrotnatotupé rovné; 12,0 cm	Noyes iris scissors; 12,0 cm	62
113 91 0494	Noyes nůžky na duhovku tupé rovné; 12,0 cm	Noyes iris scissors; 12,0 cm	62
113 91 0502	Castroviejo nůžky na duhovku ostré rovné; 9,0 cm	Castroviejo iris scissors; 9,0 cm	62
113 91 0503	Castroviejo nůžky na duhovku tupé rovné; 9,0 cm	Castroviejo iris scissors; 9,0 cm	62
113 91 0505	Castroviejo nůžky na duhovku tupé lomené; 9,0 cm	Castroviejo iris scissors; 9,0 cm	62
113 91 0507	Castroviejo nůžky na duhovku hrotnaté; 10,0 cm	Castroviejo iris scissors; 10,0 cm	62
113 91 0508	Castroviejo nůžky na duhovku tupé; 10,0 cm	Castroviejo iris scissors; 10,0 cm	62
113 91 0537	Gomel nůžky mikro tupé; 14,5 cm	Gomel dissection micro scissors; 14,5 cm	63
113 91 0538	Gomel nůžky mikro tupé; 18,0 cm	Gomel dissection micro scissors; 18,0 cm	63
113 91 0539	Gomel nůžky mikro hrotnaté; 14,5 cm	Gomel dissection micro scissors; 14,5 cm	63
113 91 0540	Gomel nůžky mikro hrotnaté; 18,0 cm	Gomel dissection micro scissors; 18,0 cm	63

číslo – number	název	item	strana – page
113 91 0552	Nůžky mikro; rovné 18,5 cm	Dissection micro scissors; straight 18,5 cm	63
113 91 0553	Nůžky mikro; zahnuté 18,5 cm	Dissection micro scissors; curved 18,5 cm	63
114	Pinzety	Forceps	
114 08 0030	Standard pinzeta anatomická; 16,0 cm	Dressing forceps; 16,0 cm	66
114 08 0040	Standard pinzeta anatomická; 20,0 cm	Dressing forceps; 20,0 cm	66
114 08 0050	Standard pinzeta anatomická; 25,0 cm	Dressing forceps; 25,0 cm	66
114 08 0060	Standard pinzeta anatomická; 30,0 cm	Dressing forceps; 30,0 cm	66
114 08 0090	Pinzeta anatomická rovná jemná; 14,5 cm	Dressing forceps; 14,5 cm	65
114 08 0101	Pinzeta anatomická jemná; 14,5 cm	Dressing forceps; 14,5 cm	65, 125
114 08 0140	Pinzeta anatomická jemná; 20,0 cm	Dressing forceps; 20,0 cm	65
114 08 0231	Pinzeta anatomická velmi jemná; 14,5 cm	Dressing forceps; 14,5 cm	65
114 08 0240	Pinzeta anatomická velmi jemná; 20,0 cm	Dressing forceps; 20,0 cm	65
114 08 0250	Pinzeta anatomická velmi jemná; 24,5 cm	Dressing forceps; 24,5 cm	65
114 08 0340	Standard pinzeta chirurgická; 20,0 cm	Tissue forceps; 20,0 cm	66
114 08 0350	Standard pinzeta chirurgická; 25,0 cm	Tissue forceps; 25,0 cm	66
114 08 0360	Standard pinzeta chirurgická; 30,0 cm	Tissue forceps; 30,0 cm	66
114 08 0381	Standard pinzeta chirurgická; 14,5 cm	Tissue forceps; 14,5 cm	66
114 08 0430	Standard pinzeta chirurgická jemná; 16,0 cm	Tissue forceps; 16,0 cm	67
114 08 0530	Pinzeta chirurgická velmi jemná; 1×2 zuby; 14,5 cm	Tissue forceps; 1×2 teeth; 14,5 cm	67
114 14 0100	Pinzeta cévní atraumatická rovná; 2,0 mm; 14,5 cm	Non-traumatic forceps; 2,0 mm; 14,5 cm	69
114 14 0300	Pinzeta cévní atraumatická rovná jemná; 14,5 cm	Non-traumatic forceps; 14,5 cm	69
114 38 0010	Graefe pinzeta oční rovná; 10,5 cm	Graefe eye forceps; 10,5 cm	70
114 38 0020	Graefe pinzeta oční rovná jemná; 10,5 cm	Graefe eye forceps; 10,5 cm	70
114 38 0100	Graefe pinzeta oční zahnutá jemná; 10,5 cm	Graefe eye forceps; 10,5 cm	70
114 38 0150	Graefe pinzeta oční rovná; 1×2 zuby; 10,5 cm	Graefe eye forceps; 1×2 teeth; 10,5 cm	70
114 38 0160	Graefe pinzeta oční rovná jemná; 1×2 zuby; 10,5 cm	Graefe eye forceps; 1×2 teeth; 10,5 cm	70
114 38 0360	Graefe pinzeta fixační s uzávěrem s perem; 11,0 cm	Graefe fixation forceps; 11,0 cm	70
114 50 0011	Pinzeta zubní s rýhovanou čelistí zahnutá; 15,7 cm	Dental forceps curved; 15,7 cm	64, 76, 122
114 50 0021	Pinzeta zubní s rýhovanou čelistí lomená; 15,7 cm	Dental forceps angled; 15,7 cm	64
114 50 0031	Pinzeta zubní s hladkou čelistí lomená; 15,7 cm	Dental forceps angled; 15,7 cm	64
114 50 0051	Pinzeta na kořenové čípky; 15,7 cm	Root suppository forceps; 15,7 cm	64
114 50 0150	Pinzeta zubní chirurgická zahnutá jemná; 14,2 cm	Dental forceps; 14,2 cm	64
114 50 0170	Pinzeta zubní chirurgická zahnutá; 15,7 cm	Dental forceps; 15,7 cm	64
114 50 1030	Pinzeta zubní lomená Dia; 15,7 cm	Dental forceps Dia; 15,7 cm	64
114 52 0020	Pinzeta laboratorní hrotnatá; 12,5 cm	Laboratory forceps; 12,5 cm	115
114 52 0030	Pinzeta laboratorní; 0,3 mm; 12,5 cm	Laboratory forceps; 0,3 mm; 12,5 cm	115
114 52 0040	Pinzeta laboratorní; 0,4 mm; 12,5 cm	Laboratory forceps; 0,4 mm; 12,5 cm	115
114 52 0050	Pinzeta laboratorní; 0,3 mm; 11,0 cm	Laboratory forceps; 0,3 mm; 11,0 cm	115
114 52 0060	Pinzeta laboratorní; 0,4 mm; 11,0 cm	Laboratory forceps; 0,4 mm; 11,0 cm	115
114 52 0100	Pinzeta zkřížená; 15,3 cm	Cross-action forceps; 15,3 cm	115
114 52 0101	Pinzeta zkřížená; 15,3 cm	Cross-action forceps; 15,3 cm	115
114 52 0110	Pinzeta zkřížená se šroubovákem; 15,5 cm	Cross-action forceps with screwdriver; 15,5 cm	115
114 91 0002	Standard pinzeta chirurgická; 11,5 cm	Tissue forceps; 11,5 cm	66
114 91 0003	Standard pinzeta chirurgická; 13,0 cm	Tissue forceps; 13,0 cm	66
114 91 0004	Standard pinzeta chirurgická; 14,5 cm	Tissue forceps; 14,5 cm	66
114 91 0006	Standard pinzeta chirurgická; 18,0 cm	Tissue forceps; 18,0 cm	66
114 91 0011	Standard pinzeta chirurgická; 11,5 cm	Tissue forceps; 11,5 cm	66
114 91 0012	Standard pinzeta chirurgická; 13,0 cm	Tissue forceps; 13,0 cm	66
114 91 0015	Standard pinzeta chirurgická; 18,0 cm	Tissue forceps; 18,0 cm	66
114 91 0255	Pinzeta šicí rovná; 0,3 mm; 12,0 cm	Suture tying forceps; 0,3 mm; 12,0 cm	67
114 91 0256	Pinzeta šicí rovná; 0,3 mm; 15,0 cm	Suture tying forceps; 0,3 mm; 15,0 cm	67
114 91 0257	Pinzeta šicí zahnutá; 0,3 mm; 12,0 cm	Suture tying forceps; 0,3 mm; 12,0 cm	67
114 91 0258	Pinzeta šicí zahnutá; 0,3 mm; 15,0 cm	Suture tying forceps; 0,3 mm; 15,0 cm	67
114 91 0451	De Bakey pinzeta atraumatická rovná; 1,5 mm; 16,0 cm	De Bakey atrauma forceps; 1,5 mm; 16,0 cm	69
114 91 0453	De Bakey pinzeta atraumatická rovná; 1,5 mm; 20,0 cm	De Bakey atrauma forceps; 1,5 mm; 20,0 cm	69
114 91 0454	De Bakey pinzeta atraumatická rovná; 1,5 mm; 24,0 cm	De Bakey atrauma forceps; 1,5 mm; 24,0 cm	69
114 91 0455	De Bakey pinzeta atraumatická rovná; 2,0 mm; 16,0 cm	De Bakey atrauma forceps; 2,0 mm; 16,0 cm	69
114 91 0457	De Bakey pinzeta atraumatická rovná; 2,0 mm; 20,0 cm	De Bakey atrauma forceps; 2,0 mm; 20,0 cm	69
114 91 0458	De Bakey pinzeta atraumatická rovná; 2,0 mm; 24,0 cm	De Bakey atrauma forceps; 2,0 mm; 24,0 cm	69
114 91 0467	De Bakey pinzeta atraumatická zahnutá; 2,0 mm; 16,0 cm	De Bakey atrauma forceps; 2,0 mm; 16,0 cm	69
114 91 0469	De Bakey pinzeta atraumatická zahnutá; 2,0 mm; 20,0 cm	De Bakey atrauma forceps; 2,0 mm; 20,0 cm	69
114 91 0470	De Bakey pinzeta atraumatická zahnutá; 2,0 mm; 24,0 cm	De Bakey atrauma forceps; 2,0 mm; 24,0 cm	69
114 91 0477	Oehler pinzeta chirurgická tvrdokov; 1×2 zuby; 14,0 cm	Oehler tissue forceps TUC; 1×2 teeth; 14,0 cm	68
114 91 0478	Oehler pinzeta chirurgická tvrdokov; 1×2 zuby; 16,0 cm	Oehler tissue forceps TUC; 1×2 teeth; 16,0 cm	68
114 91 0479	Oehler pinzeta chirurgická tvrdokov; 1×2 zuby; 18,0 cm	Oehler tissue forceps TUC; 1×2 teeth; 18,0 cm	68
114 91 0480	Oehler pinzeta chirurgická tvrdokov; 1×2 zuby; 20,0 cm	Oehler tissue forceps TUC; 1×2 teeth; 20,0 cm	68
114 91 0481	Oehler pinzeta chirurgická tvrdokov; 1×2 zuby; 25,0 cm	Oehler tissue forceps TUC; 1×2 teeth; 25,0 cm	68
114 91 0482	Oehler pinzeta chirurgická tvrdokov; 1×2 zuby; 30,0 cm	Oehler tissue forceps TUC; 1×2 teeth; 30,0 cm	68
114 91 0483	Semken pinzeta anatomická tvrdokov; 12,5 cm	Semken dissecting forceps TUC; 12,5 cm	68

číslo – number	název	item	strana – page
114 91 0484	Semken pinzeta anatomická tvrdokov; 15,5 cm	Semken dissecting forceps TUC; 15,5 cm	68
114 91 0485	Gillies pinzeta chirurgická tvrdokov; 1×2 zuby; 15,0 cm	Gillies tissue forceps TUC; 1×2 teeth; 15,0 cm	68
114 91 0486	Jeweler pinzeta tvrdokov; 15,0 cm	Jeweler forceps TUC; 15,0 cm	68
114 91 0487	Adson pinzeta anatomická tvrdokov; 12,0 cm	Adson forceps TUC; 12,0 cm	68
114 91 0489	Adson pinzeta anatomická tvrdokov; 15,0 cm	Adson forceps TUC; 15,0 cm	68
114 91 0490	Adson pinzeta chirurgická tvrdokov; 1×2 zuby; 12,0 cm	Adson forceps TUC; 1×2 teeth; 12,0 cm	68
114 91 0491	Adson pinzeta chirurgická tvrdokov; 1×2 zuby; 15,0 cm	Adson forceps TUC; 1×2 teeth; 15,0 cm	68
115	Svorky	Clamps, Forceps	
115 08 0010	Mosquito-Halsted svorka na cévy rovná; 12,0 cm	Mosquito-Halsted artery forceps; 12,0 cm	44, 125
115 08 0020	Mosquito-Halsted svorka na cévy zahnutá; 12,0 cm	Mosquito-Halsted artery forceps; 12,0 cm	44, 122
115 08 0030	Mosquito-Halsted svorka na cévy rovná; 12,0 cm	Mosquito-Halsted artery forceps; 12,0 cm	44
115 08 0040	Mosquito-Halsted svorka na cévy rovná; 12,0 cm	Mosquito-Halsted artery forceps; 12,0 cm	44
115 08 0050	Mosquito-Halsted svorka na cévy zahnutá; 12,0 cm	Mosquito-Halsted artery forceps; 12,0 cm	44
115 08 0060	Mosquito-Halsted svorka na cévy zahnutá; 12,0 cm	Mosquito-Halsted artery forceps; 12,0 cm	44
115 08 0260	Rochester-Pean svorka na cévy zahnutá; 14,0 cm	Rochester-Pean artery forceps; 14,0 cm	46
115 08 0500	Kelly svorka na cévy zahnutá; 14,0 cm	Kelly artery forceps; 14,0 cm	46
115 08 0780	Backhaus svorka na prádlo; 11,8 cm	Backhaus towel forceps; 11,8 cm	48
115 08 0790	Backhaus svorka na prádlo; 12,0 cm	Backhaus towel forceps; 12,0 cm	48
115 08 0810	Backhaus svorka na prádlo; 8,0 cm	Backhaus towel forceps; 8,0 cm	48
115 08 0820	Backhaus svorka na prádlo; 13,0 cm	Backhaus towel forceps; 13,0 cm	48
115 08 1010	Mosquito-Halsted svorka na cévy rovná; 12,0 cm	Mosquito-Halsted artery forceps; 12,0 cm	44
115 08 1020	Mosquito-Halsted svorka na cévy zahnutá; 12,0 cm	Mosquito-Halsted artery forceps; 12,0 cm	44
115 08 1030	Mosquito-Halsted svorka na cévy rovná; 12,0 cm	Mosquito-Halsted artery forceps; 12,0 cm	44
115 08 1050	Mosquito-Halsted svorka na cévy zahnutá; 12,0 cm	Mosquito-Halsted artery forceps; 12,0 cm	44
115 91 0068	Hartmann svorka rovná; 10,0 cm	Hartmann forceps; 10,0 cm	45
115 91 0069	Hartmann svorka zahnutá; 10,0 cm	Hartmann forceps; 10,0 cm	45
115 91 0073	Micro-Mosquito svorka na cévy rovná; 12,0 cm	Micro-Mosquito artery forceps; 12,0 cm	45
115 91 0075	Micro-Mosquito svorka na cévy zahnutá; 12,0 cm	Micro-Mosquito artery forceps; 12,0 cm	45
115 91 0077	Micro-Mosquito svorka rovná 1×2 zuby; 12,0 cm	Micro-Mosquito artery forceps; 1×2 teeth; 12,0 cm	45
115 91 0079	Micro-Mosquito svorka zahnutá 1×2 zuby; 12,0 cm	Micro-Mosquito artery forceps; 1×2 teeth; 12,0 cm	45
115 91 0080	Halsted-Mosquito svorka na cévy rovná; 12,5 cm	Halsted-Mosquito artery forceps straight; 12,5 cm	45
115 91 0082	Halsted-Mosquito svorka na cévy zahnutá; 12,5 cm	Halsted-Mosquito artery forceps curved; 12,5 cm	45
115 91 0084	Halsted-Mosquito svorka; 1×2 zuby rovná; 12,5 cm	Halsted-Mosquito artery forceps straight; 1×2 teeth; 12,5 cm	45
115 91 0086	Halsted-Mosquito svorka zahnutá; 1×2 zuby; 12,5 cm	Halsted-Mosquito artery forceps curved; 1×2 teeth; 12,5 cm	45
115 91 0341	Backhaus-Clip svorka na prádlo; 11,0 cm	Backhaus-Clip towel forceps; 11,0 cm	48
115 91 0343	Backhaus svorka na prádlo; 11,0 cm	Backhaus towel forceps; 11,0 cm	48
115 91 0345	Backhaus svorka na prádlo; 15,0 cm	Backhaus towel forceps; 15,0 cm	48
115 91 0348	Roeder svorka na prádlo; 13,0 cm	Roeder towel forceps; 13,0 cm	49
115 91 0349	Roeder svorka na prádlo; 15,0 cm	Roeder towel forceps; 15,0 cm	49
115 91 0350	Lorna svorka na prádlo; 10,0 cm	Lorna towel forceps; 10,0 cm	49
115 91 0351	Lorna svorka na prádlo; 13,0 cm	Lorna towel forceps; 13,0 cm	49
115 91 0352	Tohoku-Japan svorka na prádlo; 10,0 cm	Tohoku-Japan towel forceps; 10,0 cm	49
115 91 0353	Tohoku-Japan svorka na prádlo; 13,0 cm	Tohoku-Japan towel forceps; 13,0 cm	49
115 91 0354	Peers svorka na prádlo; 10,0 cm	Peers towel forceps; 10,0 cm	49
115 91 0382	Babcock svorka chirurgická; 16,0 cm	Babcock tissue seizing forceps; 16,0 cm	46
115 91 0591	De Bakey-Pean svorka atraumatická; 14,0 cm	De Bakey-Pean atrauma forceps; 14,0 cm	47
115 91 0592	De Bakey-Pean svorka atraumatická; 14,0 cm	De Bakey-Pean atrauma forceps; 14,0 cm	47
115 91 0596	De Bakey-Mosquito svorka atraumatická; 12,0 cm	De Bakey-Mosquito atrauma forceps; 12,0 cm	47
115 91 0625	De Bakey-Rankin svorka atraumatická; 16,0 cm	De Bakey-Rankin atrauma forceps; 16,0 cm	47
115 91 0626	De Bakey-Rankin svorka atraumatická; 16,0 cm	De Bakey-Rankin atrauma forceps; 16,0 cm	47
115 91 0627	De Bakey-Mosquito svorka atraumatická; 15,0 cm	De Bakey-Mosquito atrauma forceps; 15,0 cm	47
115 91 0628	De Bakey-Mosquito svorka atraumatická; 15,0 cm	De Bakey-Mosquito atrauma forceps; 15,0 cm	47
115 91 0629	De Bakey-Mosquito svorka atraumatická; 12,0 cm	De Bakey-Mosquito atrauma forceps; 12,0 cm	47
115 91 0630	De Bakey-Pean svorka atraumatická; 16,0 cm	De Bakey-Pean atrauma forceps; 16,0 cm	47
115 91 0632	De Bakey-Pean svorka atraumatická; 16,0 cm	De Bakey-Pean atrauma forceps; 16,0 cm	47
116	Kleště štípací	Bone Rongeurs	
116 08 0030	Luer kleště štípací na kosti rovné; 17,0 cm	Luer bone rongeurs; 17,0 cm	17
116 08 0070	Luer kleště štípací na kosti silně Zahn.; 15,0 cm	Luer bone rongeurs; 15,0 cm	17
116 08 0080	Luer kleště štípací na kosti zahnuté; 14,5 cm	Luer bone rongeurs; 14,5 cm	17
116 08 0280	Kleště štípací; 14,0 cm	Bone rongeurs; 14,0 cm	18
116 08 0410	Liston kleště štípací rovné; 14,0 cm	Liston bone rongeurs; 14,0 cm	18
116 08 0440	Liston kleště štípací rovné; 19,0 cm	Liston bone rongeurs; 19,0 cm	18
116 08 0450	Liston kleště štípací zahnuté; 19,0 cm	Liston bone rongeurs; 19,0 cm	18
116 29 0410	Jansen kleště štípací fig. 2; 18,0 cm	Jansen mastoid forceps fig. 2; 18,0 cm	17
116 91 0001	Kleště štípací na drát; 14,5 cm	Wire cutting forceps; 14,5 cm	117
116 91 0005	Kleště štípací na drát; 17,0 cm	Wire cutting forceps; 17,0 cm	117
116 91 0017	Mini-Friedman kleště štípací na kosti; 12,0 cm	Mini-Friedman bone ronguers; 12,0 cm	16
116 91 0514	Friedman kleště štípací na kosti; 14,0 cm	Friedman bone ronguers; 14,0 cm	16
116 91 0515	Stellbrink kleště štípací na kosti; 17,0 cm	Stellbrink bone ronguers; 17,0 cm	16

číslo – number	název	item	strana – page
116 91 0516	Stellbrink kleště štípací na kosti; 17,0 cm	Stellbrink bone ronguers; 17,0 cm	16
116 91 0518	Cleveland kleště štípací na kosti; 17,0 cm	Cleveland bone ronguers; 17,0 cm	16
116 91 0522	Blumenthal kleště štípací na kosti; 15,5 cm	Blumenthal bone ronguers; 15,5 cm	16
116 91 0523	Blumenthal kleště štípací na kosti; 15,5 cm	Blumenthal bone ronguers; 15,5 cm	16
116 91 0524	Blumenthal kleště štípací na kosti; 15,5 cm	Blumenthal bone ronguers; 15,5 cm	16
116 91 0527	Luer kleště štípací na kosti; 15,0 cm	Luer bone ronguers; 15,0 cm	16
116 91 0528	Luer kleště štípací na kosti; 15,0 cm	Luer bone ronguers; 15,0 cm	16
116 91 0529	Luer kleště štípací na kosti; 15,0 cm	Luer bone ronguers; 15,0 cm	16
117	Kleště úchopné, extrakční	Grasping Forceps, Extraction Forceps	
117 31 0010	Collin kleště na jazyk okénkované; 16,7 cm	Collin tongue holding forceps; 16,7 cm	19
117 31 0030	Löbker kleště na jazyk jednoháčkové; 15,0 cm	Löbker tongue holding forceps; 15,0 cm	19
117 50 0010	Kleště extrakční D2	Extraction forceps D2	11
117 50 0020	Kleště extrakční D7	Extraction forceps D7	11
117 50 0030	Kleště extrakční D17	Extraction forceps D17	11
117 50 0040	Kleště extrakční D18	Extraction forceps D18	11
117 50 0050	Kleště extrakční D67	Extraction forceps D67	13
117 50 0060	Kleště extrakční D30S	Extraction forceps D30S	13
117 50 0150	Kleště extrakční D13	Extraction forceps D13	12
117 50 0160	Kleště extrakční D22	Extraction forceps D22	12
117 50 0170	Kleště extrakční D73	Extraction forceps D73	14
117 50 0180	Kleště extrakční D79	Extraction forceps D79	14
117 50 0190	Kleště extrakční D33A	Extraction forceps D33a	12
117 50 0200	Kleště extrakční D33	Extraction forceps D33	12
117 50 0250	Kleště extrakční D51A	Extraction forceps D51A	13
117 50 0260	Kleště extrakční D51	Extraction forceps D51	13
117 50 0300	Kleště extrakční D342	Extraction forceps D342	15
117 50 0310	Kleště extrakční D339	Extraction forceps D339	15
117 50 0330	Kleště extrakční D74N	Extraction forceps D74N	14
117 50 0340	Kleště extrakční D74M	Extraction forceps D74M	14
117 50 0350	Kleště extrakční D74	Extraction forceps D74	14
117 50 1010	Kleště extrakční D2 diamantované	Extraction forceps D2 diamond	11
117 50 1020	Kleště extrakční D7 diamantované	Extraction forceps D7 diamond	11
117 50 1030	Kleště extrakční D17 diamantované	Extraction forceps D17 diamond	11
117 50 1040	Kleště extrakční D18 diamantované	Extraction forceps D18 diamond	11
117 50 1050	Kleště extrakční D67 diamantované	Extraction forceps D67 diamond	13
117 50 1060	Kleště extrakční D30S diamantované	Extraction forceps D30S diamond	13
117 50 1150	Kleště extrakční D13 diamantované	Extraction forceps D13 diamond	12
117 50 1160	Kleště extrakční D22 diamantované	Extraction forceps D22 diamond	12
117 50 1170	Kleště extrakční D73 diamantované	Extraction forceps D73 diamond	14
117 50 1180	Kleště extrakční D79 diamantované	Extraction forceps D79 diamond	14
117 50 1190	Kleště extrakční D33A diamantované	Extraction forceps D33A diamond	12
117 50 1200	Kleště extrakční D33 diamantované	Extraction forceps D33 diamond	12
117 50 1250	Kleště extrakční D51A diamantované	Extraction forceps D51A diamond	13
117 50 1260	Kleště extrakční D51 diamantované	Extraction forceps D5 diamond	13
117 50 1300	Kleště extrakční D342 diamantované	Extraction forceps D342 diamond	15
117 50 1310	Kleště extrakční D339 diamantované	Extraction forceps D339 diamond	15
117 50 1330	Kleště extrakční D74N diamantované	Extraction forceps D74N diamond	14
117 50 1340	Kleště extrakční D74M diamantované	Extraction forceps D74M diamond	14
117 50 1350	Kleště extrakční D74 diamantované	Extraction forceps D74 diamond	14
117 51 0600	Kleště k odstranění kořen.nástrojů rovné; 13,5 cm	Forceps for extraction of root instruments; 13,5 cm	15
117 51 0610	Kleště k odstranění kořen.nástrojů zahnuté; 13,5 cm	Forceps for extraction of root instruments; 13,5 cm	15
117 51 1600	Kleště k odstranění kořen.nástrojů rovné Dia; 13,5 cm	Forceps for extraction of root instruments straight Dia; 13,5 cm	15
117 51 1610	Kleště k odstranění kořen.nástrojů zahnuté Dia; 13,3 cm	Forceps for extraction of root instruments curved Dia; 13,3 cm	15
117 52 0700	Kleště laboratorní fig. 1; 13,5 cm	Laboratory forceps fig. 1; 13,5 cm	118, 122
117 52 0770	Kleště na kelímky; 50,0 cm	Crucible forceps; 50,0 cm	117
117 52 0780	Kleště na kelímky; 27,5 cm	Crucible forceps; 27,5 cm	117
117 52 0800	Kleště laboratorní ploché; 13,4 cm	Laboratory forceps with flat jaws; 13,4 cm	118
117 52 0810	Kleště laboratorní oblé; 13,4 cm	Laboratory forceps with rounded jaws; 13,4 cm	118
117 52 0820	Kleště laboratorní kuželové; 13,4 cm	Laboratory forceps with conical jaws; 13,4 cm	118
117 52 0830	Kleště laboratorní čočkové; 13,4 cm	Laboratory forceps with lens jaws; 13,4 cm	118
117 52 0840	Kleště laborat.ploché vroubk.čelis. fig. 1; 13,5 cm	Laboratory forceps with flat jaws fig. 1; 13,5 cm	119
117 52 0850	Kleště laborat.ohýbací se žlábkem fig. 2; 13,3 cm	Laboratory forceps with groove jaws fig. 2; 13,3 cm	119
117 52 0860	Kleště laborat.ohýbací se žlábkem fig. 3; 13,0 cm	Laboratory forceps with groove jaws fig. 3; 13,0 cm	119
117 52 0870	Kleště laboratorní ploché fig. 4; 13,0 cm	Laboratory forceps with flat jaws fig. 4; 13,0 cm	119
117 52 0880	Kleště laboratorní ohýbací velké fig. 5; 12,2 cm	Laboratory bending forceps fig. 5; 12,2 cm	120
117 52 0890	Kleště laboratorní ohýbací malé fig. 6; 11,9 cm	Laboratory bending forceps fig. 6; 11,9 cm	120
117 52 1000	Kleště laboratorní utahovací; 13,6 cm	Laboratory tighten forceps; 13,6 cm	120
117 52 1010	Kleště laboratorní ohýbací; 13,6 cm	Laboratory bending forceps; 13,6 cm	120
117 91 0001	Lister kleště tamponové; 13,0 cm	Lister sinus forceps; 13,0 cm	19

číslo – number	název	item	strana – page
117 91 0002	Lister kleště tamponové; 16,0 cm	Lister sinus forceps; 16,0 cm	19
117 91 0003	Lister kleště tamponové; 18,0 cm	Lister sinus forceps; 18,0 cm	19
117 91 0033	Collin kleště tamponové; 24,0 cm	Collin dressing forceps; 24,0 cm	19
117 91 0038	Heywood-Smith kleště tamponové; 21,0 cm	Heywood-Smith sponge holding forceps; 21,0 cm	19
117 91 0039	Heywood-Smith kleště tamponové; 25,0 cm	Heywood-Smith sponge holding forceps; 25,0 cm	19
118	Háčky	Hooks, Retractors	
118 08 0010	Háček na rány jednozubý ostrý; 16,0 cm	Delicate hook one-pronged sharp; 16,0 cm	31
118 08 0020	Háček na rány dvouzubý ostrý; 16,0 cm	Delicate hook two-pronged sharp; 16,0 cm	31
118 08 0050	Háček na rány jednozubý tupý; 16,0 cm	Delicate hook one-pronged blunt; 16,0 cm	31
118 08 0060	Háček na rány dvouzubý tupý; 16,0 cm	Delicate hook two-pronged blunt; 16,0 cm	31
118 08 0650	Middeldorpf hák na rány okénk.; 14×12 mm; 22,0 cm	Middeldorpf retractor; 14×12 mm; 22,0 cm	34
118 08 0660	Middeldorpf hák na rány okénk.; 21×21 mm; 22,0 cm	Middeldorpf retractor; 21×21 mm; 22,0 cm	34
118 08 0670	Middeldorpf hák na rány okénk.; 32×31 mm; 23,5 cm	Middeldorpf retractor; 32×31 mm; 23,5 cm	34
118 08 0680	Middeldorpf hák na rány okénk.; 62×50 mm; 28,0 cm	Middeldorpf retractor; 62×50 mm; 28,0 cm	34
118 08 0800	Langenbeck hák na rány; 40×10 mm; 21,0 cm	Langenbeck retractor; 40×10 mm; 21,0 cm	35
118 08 0810	Langenbeck hák na rány; 42×13 mm; 21,0 cm	Langenbeck retractor; 42×13 mm; 21,0 cm	35
118 12 0010	Háček pro plastiku jednozubý ostrý fig. 1; 16,0 cm	Plastic hook one-pronged sharp; fig. 1; 16,0 cm	33
118 12 0020	Háček pro plastiku jednozubý ostrý fig. 2; 16,0 cm	Plastic hook one-pronged sharp; fig. 2; 16,0 cm	33
118 12 0050	Háček pro plastiku dvouzubý tupý; 5,0 mm; 16,0 cm	Plastic hook 2 prongs blunt; 5,0 mm; 16,0 cm	33
118 12 0060	Háček pro plastiku dvouzubý ostrý; 5,0 mm; 16,0 cm	Plastic hook 2 prongs sharp; 5,0 mm; 16,0 cm	33
118 31 0040	Hák resekcční čtyřzubý rovný; 16,4 cm	Resection hook four-pronged straight; 16,4 cm	35
118 31 0070	Hák resekcční dvouzubý rovný; 16,4 cm	Resection hook two-pronged straight; 16,4 cm	35
118 38 0010	Desmarres háček jemný; 10,0 mm; 13,0 cm	Desmarres delicate hook; 10,0 mm; 13,0 cm	32
118 38 0020	Desmarres háček jemný; 12,0 mm; 13,0 cm	Desmarres delicate hook; 12,0 mm; 13,0 cm	32
118 38 0030	Desmarres háček jemný; 14,0 mm; 13,0 cm	Desmarres delicate hook; 14,0 mm; 13,0 cm	32
118 38 0210	Háček oční dvouzubý ostrý; 2,6 mm; 13,5 cm	Eye hook two-pronged sharp; 2,6 mm; 13,5 cm	33
118 38 0220	Háček oční dvouzubý ostrý; 3,2 mm; 13,5 cm	Eye hook two-pronged sharp; 3,2 mm; 13,5 cm	33
118 38 0230	Háček oční dvouzubý ostrý; 4,0 mm; 13,5 cm	Eye hook two-pronged sharp; 4,0 mm 13,5 cm	33
118 38 0360	Háček oční čtyřzubý ostrý; 5,0 mm; 14,5 cm	Eye hook four-pronged sharp; 5,0 mm; 14,5 cm	33
118 50 0120	Hák intraorální; 22,9 cm	Intraolar hook; 22,9 cm	36
118 91 0027	Háček na rány trojzubý ostrý; 16,0 cm	Delicate hook three-pronged sharp; 16,0 cm	31
118 91 0028	Háček na rány čtyřzubý ostrý; 16,0 cm	Delicate hook four-pronged sharp; 16,0 cm	31
118 91 0035	Háček na rány trojzubý tupý; 16,0 cm	Delicate hook three-pronged blunt; 16,0 cm	31
118 91 0036	Háček na rány čtyřzubý tupý; 16,0 cm	Delicate hook four-pronged blunt; 16,0 cm	31
118 91 0045	Háček na rány dvouzubý ostrý; 16,0 cm	Delicate hook two-pronged sharp; 16,0 cm	31
118 91 0046	Háček na rány trojzubý ostrý; 16,0 cm	Delicate hook three-pronged sharp; 16,0 cm	31
118 91 0047	Háček na rány čtyřzubý ostrý; 16,0 cm	Delicate hook four-pronged sharp; 16,0 cm	31
118 91 0048	Háček na rány dvouzubý tupý; 16,0 cm	Delicate hook two-pronged blunt; 16,0 cm	31
118 91 0049	Háček na rány trojzubý tupý; 16,0 cm	Delicate hook three-pronged blunt; 16,0 cm	31
118 91 0050	Háček na rány čtyřzubý tupý; 16,0 cm	Delicate hook four-pronged blunt; 16,0 cm	31
118 91 0051	Joseph háček na rány jednozubý ostrý; 16,0 cm	Joseph delicate hook one-pronged sharp; 16,0 cm	31
118 91 0052	Joseph háček na rány dvouzubý ostrý, 2,0 mm; 16,0 cm	Joseph delicate hook two-pronged sharp; 16,0 cm	31
118 91 0053	Joseph háček na rány dvouzubý ostrý, 5,0 mm; 16,0 cm	Joseph delicate hook two-pronged sharp; 16,0 cm	31
118 91 0054	Joseph háček na rány dvouzubý ostrý, 7,0 mm; 16,0 cm	Joseph delicate hook two-pronged sharp; 16,0 cm	31
118 91 0055	Joseph háček na rány dvouzubý ostrý, 10,0 mm; 16,0 cm	Joseph delicate hook two-pronged sharp; 16,0 cm	31
118 91 0069	Mini-Langenbeck háček jemný; 16,0 cm	Mini-Langenbeck delicate hook; 16,0 cm	32
118 91 0070	Mini-Langenbeck háček jemný; 16,0 cm	Mini-Langenbeck delicate hook; 16,0 cm	32
118 91 0071	Mini-Langenbeck háček jemný; 16,0 cm	Mini-Langenbeck delicate hook; 16,0 cm	32
118 91 0072	Mini-Langenbeck háček jemný; 16,0 cm	Mini-Langenbeck delicate hook; 16,0 cm	32
118 91 0077	Desmarres háček jemný; 16,0 mm; 13,0 cm	Desmarres delicate hook; 16,0 mm; 13,0 cm	32
118 91 0078	Desmarres háček jemný; 18,0 mm; 13,0 cm	Desmarres delicate hook; 18,0 mm; 13,0 cm	32
118 91 0085	Cushing háček jemný; 8,0 mm; 20,0 cm	Cushing delicate hook; 8,0 mm; 20,0 cm	32
118 91 0086	Cushing háček jemný; 10,0 mm; 20,0 cm	Cushing delicate hook; 10,0 mm; 20,0 cm	32
118 91 0087	Cushing háček jemný; 12,0 mm; 20,0 cm	Cushing delicate hook; 12,0 mm; 20,0 cm	32
118 91 0088	Cushing háček jemný; 14,0 mm; 20,0 cm	Cushing delicate hook; 14,0 mm; 20,0 cm	32
118 91 0089	Cushing háček jemný; 16,0 mm; 20,0 cm	Cushing delicate hook; 16,0 mm; 20,0 cm	32
118 91 0090	Cushing háček jemný; 18,0 mm; 20,0 cm	Cushing delicate hook; 18,0 mm; 20,0 cm	32
118 91 0091	Cushing háček jemný; 8,0 mm; 24,0 cm	Cushing delicate hook; 8,0 mm; 24,0 cm	32
118 91 0092	Cushing háček jemný; 10,0 mm; 24,0 cm	Cushing delicate hook; 10,0 mm; 24,0 cm	32
118 91 0093	Cushing háček jemný; 12,0 mm; 24,0 cm	Cushing delicate hook; 12,0 mm; 24,0 cm	32
118 91 0094	Cushing háček jemný; 14,0 mm; 24,0 cm	Cushing delicate hook; 14,0 mm; 24,0 cm	32
118 91 0095	Cushing háček jemný; 16,0 mm; 24,0 cm	Cushing delicate hook; 16,0 mm; 24,0 cm	32
118 91 0096	Cushing háček jemný; 18,0 mm; 24,0 cm	Cushing delicate hook; 18,0 mm; 24,0 cm	32
118 91 0208	Middeldorpf hák na rány okénk.; 14×17 mm; 21,5 cm	Middeldorpf retractor; 14×17 mm; 21,5 cm	34
118 91 0209	Middeldorpf hák na rány okénk.; 20×22 mm; 22,0 cm	Middeldorpf retractor; 20×22 mm; 22,0 cm	34
118 91 0210	Middeldorpf hák na rány okénk.; 26×30 mm; 23,5 cm	Middeldorpf retractor; 26×30 mm; 23,5 cm	34
118 91 0294	Roux hák sada fig.1-3; 16,5 cm	Roux retractor set fig.1-3; 16,5 cm	35
118 91 0295	Roux hák fig.1	Roux retractor fig.1	35
118 91 0296	Roux hák fig.2	Roux retractor fig.2	35

číslo – number	název	item	strana – page
118 91 0297	Roux hák fig.3	Roux retractor fig.3	35
118 99 0086	Hák intraorální malý; 22,9 cm	Intraoral hook; small; 22,9 cm	36
119	Rozvěrače	Retractors	
119 07 0010	Roser-König rozvěrač úst; 19,5 cm	Roser-König mouth retractor; 19,5 cm	37
119 07 0020	Heister rozvěrač úst; 13,0 cm	Heister mouth retractor; 13,0 cm	37
119 91 0185	Jennings rozvěrač úst; 9,0 cm	Jennings mouth retractor; 9,0 cm	37
119 91 0186	Jennings rozvěrač úst; 11,0 cm	Jennings mouth retractor; 11,0 cm	37
119 91 0187	Jennings rozvěrač úst; 13,0 cm	Jennings mouth retractor; 13,0 cm	37
119 91 0188	Jennings rozvěrač úst; 15,0 cm	Jennings mouth retractor; 15,0 cm	37
119 91 0190	Whitehead rozvěrač úst; 11,0 cm	Whitehead mouth retractor; 11,0 cm	37
119 91 0191	Whitehead rozvěrač úst; 13,0 cm	Whitehead mouth retractor; 13,0 cm	37
119 91 0192	Whitehead rozvěrač úst; 15,0 cm	Whitehead mouth retractor; 15,0 cm	37
119 91 0194	Whitehead rozvěrač úst; 11,0 cm	Whitehead mouth retractor; 11,0 cm	37
119 91 0195	Whitehead rozvěrač úst; 13,0 cm	Whitehead mouth retractor; 13,0 cm	37
119 91 0196	Whitehead rozvěrač úst; 15,0 cm	Whitehead mouth retractor; 15,0 cm	37
121	Lopatky	Spatulas	
121 31 0010	Buchwald lopatka na jazyk; 16x23 mm; 17,3 cm	Buchwald tongue spatula; 16x23 mm; 17,3 cm	74
121 31 0020	Brünnings lopatka na jazyk; 14x18 mm; 19,5 cm	Brünnings tongue spatula; 14x18 mm; 19,5 cm	74
121 52 0010	Lopatka na cement oboustranná; 5 mm; 18,0 cm	Cement spatula; 5 mm; 18,0 cm	95, 121
121 52 0020	Lopatka na cement oboustranná; 7,5 mm; 18,0 cm	Cement spatula; 7,5 mm; 18,0 cm	95, 121
121 52 0050	Nůž na sádku s otvíračem kyvet; 18,0 cm	Plaster knife; 18,0 cm	121, 122
121 52 0060	Lopatka na sádku; 16,8 cm	Plaster spatula; 16,8 cm	121
121 52 0080	Lopatka na míchání otiskov.hmot; 21,0 cm	Mixing spatula; 21,0 cm	95, 121
122	Zrcátka	Mirrors	
122 51 0010	Zrcátko zubní ploché; 24 mm	Mouth mirror flat; 24 mm	75
122 51 0020	Zrcátko zubní zvětšovací; 24 mm	Mouth mirror magnifying; 24 mm	75, 76
122 51 0100	Držátko zubního zrcátka; 12,0 cm	Mirror handle; 12,0 cm	75, 76
122 51 0106	Držátko zubního zrcátka; 12,0 cm	Mirror handle; 12,0 cm	75
122 56 0106	Držátko zubního zrcátka; 13,0 cm	Dental mirror hollow handle; 13,0 cm	75
122 91 0333	Zrcátko zubní ploché HR Front; vel. 5; 24 mm	Mouth mirror flat HR Front; size 5; 24 mm	75
122 91 0407	Zrcátko zubní ploché HR Front; vel. 4; 22 mm	Mouth mirror flat HR Front; size 4; 22 mm	75
122 91 0408	Zrcátko zubní ploché HR Front; vel. 0; 14 mm	Mouth mirror flat HR Front; size 0; 14 mm	75
122 91 0411	Zrcátko zubní ploché HR Front; vel. 8; 30 mm	Mouth mirror flat HR Front; size 8; 30 mm	75
122 91 0420	Zrcátko intraorální bukalní HR Front jednostranné; 16,0 cm	Intraoral mirror buccal HR Front one-side coated; 16,0 cm	74
122 91 0421	Zrcátko intraorální okluzní HR Front jednostranné; 15,0 cm	Intraoral mirror occlusal HR Front one-side coated; 15,0 cm	74
122 91 0422	Zrcátko intraorální linguální HR Front oboustranné; 16,0 cm	Intraoral mirror lingual HR Front double-side coated; 16,0 cm	74
123	Páčidla, páky	Elevators	
123 08 0010	Langenbeck páčidlo fig. 1; 19,5 cm	Langenbeck elevator; fig. 1; 19,5 cm	20
123 08 0020	Langenbeck páčidlo fig. 2; 19,5 cm	Langenbeck elevator; fig. 2; 19,5 cm	20
123 08 0030	Williger páčidlo fig. 1; 16,0 cm	Williger elevator; fig. 1; 16,0 cm	20
123 30 0030	Freer páčidlo na nosní přepážku dvojité; 17,9 cm	Freer septum elevator; 17,9 cm	20
123 50 0010	Bein páka extrakční rovná; 3 mm; 14,5 cm	Bein root elevator straight; 3 mm; 14,5 cm	21
123 50 0011	Bein páka extrakční rovná; 3 mm; 16,5 cm	Bein root elevator straight; 3 mm; 16,5 cm	21
123 50 0020	Bein páka extrakční rovná; 4 mm; 14,5 cm	Bein root elevator straight; 4 mm; 14,5 cm	21
123 50 0021	Bein páka extrakční rovná; 4 mm; 16,5 cm	Bein root elevator straight; 4 mm; 16,5 cm	21
123 50 0050	Bein páka extrakční oblouk.; 3 mm; 14,5 cm	Bein root elevator embowed; 3 mm; 14,5 cm	21
123 50 0051	Bein páka extrakční oblouk.; 3 mm; 16,5 cm	Bein root elevator embowed; 3 mm; 16,5 cm	21
123 50 0060	Bein páka extrakční oblouk.; 4 mm; 14,5 cm	Bein root elevator embowed; 4 mm; 14,5 cm	21
123 50 0061	Bein páka extrakční oblouk.; 4 mm; 16,5 cm	Bein root elevator embowed; 4 mm; 16,5 cm	21
123 50 0080	Bein páka extrakční rovná jemná; 3 mm; 14,5 cm	Bein root elevator straight fine; 3 mm; 14,5 cm	22
123 50 0081	Bein páka extrakční rovná jemná; 3 mm; 16,5 cm	Bein root elevator straight fine; 3 mm; 16,5 cm	22
123 50 0090	Bein páka extrakční rovná jemná; 4 mm; 14,5 cm	Bein root elevator straight fine; 4 mm; 14,5 cm	22
123 50 0091	Bein páka extrakční rovná jemná; 4 mm; 16,5 cm	Bein root elevator straight fine; 4 mm; 16,5 cm	22
123 50 0100	Flohr páka extrakční hrotnatá pravá; 3 mm; 13,0 cm	Flohr root elevator pointed right fine; 3 mm; 13,0 cm	22
123 50 0101	Flohr páka extrakční hrotnatá pravá; 3 mm; 15,0 cm	Flohr root elevator pointed right fine; 3 mm; 15,0 cm	22
123 50 0110	Flohr páka extrakční hrotnatá levá; 3 mm; 13,0 cm	Flohr root elevator pointed left fine; 3 mm; 13,0 cm	22
123 50 0111	Flohr páka extrakční hrotnatá levá; 3 mm; 15,0 cm	Flohr root elevator pointed left fine; 3 mm; 15,0 cm	22
123 50 0130	Schlemmer páka extrakční pravá; 15,1 cm	Schlemmer root elevator right; 15,1 cm	23
123 50 0131	Schlemmer páka extrakční pravá; 17,1 cm	Schlemmer root elevator right; 17,1 cm	23
123 50 0140	Schlemmer páka extrakční levá; 15,1 cm	Schlemmer root elevator left; 15,1 cm	23
123 50 0141	Schlemmer páka extrakční levá; 17,1 cm	Schlemmer root elevator left; 17,1 cm	23
123 50 0160	Páka extrakční rovná pravá; 4 mm; 14,5 cm	Root elevator straight right; 4 mm; 14,5 cm	23
123 50 0170	Páka extrakční rovná levá; 4 mm; 14,5 cm	Root elevator straight left; 4 mm; 14,5 cm	23
123 50 0210	Špinar páka extrakční přední; 4 mm; 14,8 cm	Špinar root elevator frontal; 4 mm; 14,8 cm	24
123 50 0211	Špinar páka extrakční přední; 4 mm; 16,8 cm	Špinar root elevator frontal; 4 mm; 16,8 cm	24
123 50 0220	Špinar páka extrakční zadní; 4 mm; 14,8 cm	Špinar root elevator retral; 4 mm; 14,8 cm	24
123 50 0221	Špinar páka extrakční zadní; 4 mm; 16,8 cm	Špinar root elevator retral; 4 mm; 16,8 cm	24
123 50 0280	White páka extrakční s oblouk. ostřím vyhn.; 3 mm; 14,5 cm	Root elevator with embowed edge; 3 mm; 14,5 cm	24
123 50 0290	White páka extrakční s oblouk. ostřím vyhn.; 4 mm; 14,5 cm	Root elevator with embowed edge; 4 mm; 14,5 cm	24

číslo – number	název	item	strana – page
123 50 0301	Barry páka extrakční pravá; 9,5 mm; 12,4 cm	Barry root elevator right; 9,5 mm; 12,4 cm	25
123 50 0311	Barry páka extrakční levá; 9,5 mm; 12,4 cm	Barry root elevator left; 9,5 mm; 12,4 cm	25
123 50 0361	Lecluse páka extrakční; 6,5 mm; 10,8 cm	Lecluse root elevator; 6,5 mm; 10,8 cm	25
123 50 0380	White páka extrakční s oblouk. ostřím vyhn.; 3 mm; 14,5 cm	Root elevator with embowed edge; 3 mm; 14,5 cm	25
123 50 0390	White páka extrakční s oblouk. ostřím vyhn.; 4 mm; 14,5 cm	Root elevator with embowed edge; 4 mm; 14,5 cm	25
123 50 0610	Nástroj na snímání korunek; 23,3 cm	Crown remover; 23,3 cm	98
123 50 0630	Páka extrakční se zuby rovná; 4 mm; 14,5 cm	Root elevator with saw edge; 4 mm; 14,5 cm	25
123 91 0006	Freer páčidlo nosní ostré; 19,0 cm	Freer nasal elevator; 19,0 cm	20
123 91 0007	Freer páčidlo nosní tupé; 19,0 cm	Freer nasal elevator; 19,0 cm	20
123 91 0008	Freer páčidlo nosní ostro-tupé; 18,0 cm	Freer nasal elevator; 18,0 cm	20
123 99 0084	Páčidlo na nosní přepážku; 3,8/4,2 mm; 17,0 cm	Septum nasal elevator; 3,8/4,2 mm; 17,0 cm	20
124	Škrabky	Raspatories	
124 08 0111	Williger škrabka fig. 2; 16,0 cm	Williger raspatory; fig. 2; 16,0 cm	26
124 08 0120	Langenbeck škrabka; 20,5 cm	Langenbeck raspatory; 20,5 cm	26
124 08 0130	Langenbeck škrabka; 20,4 cm	Langenbeck raspatory; 20,4 cm	26
124 08 0250	Williger škrabka 5 mm; 18,0 cm	Williger raspatory; 18,0 cm	26
124 08 0280	Williger škrabka rovná 3,5 mm; 16,0 cm	Williger raspatory; 16,0 cm	26
124 08 0290	Williger škrabka zahnutá 3,5 mm; 16,0 cm	Williger raspatory; 16,0 cm	26
124 30 0020	Přecechtěl škrabka nosní; 19,0 cm	Přecechtěl nasal raspatory; 19,0 cm	26
124 38 0160	Škrabka na operaci slzného vaku; 17,2 cm	Lachrymal sac raspatory; 17,2 cm	26
124 58 0010	Furkační kyreta; 17,2 cm	Furcation curette; 17,2 cm	105
124 58 0020	Furkační kyreta; 17,2 cm	Furcation curette; 17,2 cm	105
125	Lžičky	Bone Curettes, Spoons	
125 08 0110	Lžička ostrá fig. 000; 17,0 cm	Sharp spoon; fig. 000; 17,0 cm	39
125 08 0120	Lžička ostrá fig. 0; 17,2 cm	Sharp spoon; fig. 0; 17,2 cm	39
125 08 0130	Lžička ostrá fig. 1; 17,5 cm	Sharp spoon; fig. 1; 17,5 cm	39
125 08 0140	Lžička ostrá fig. 3; 17,7 cm	Sharp spoon; fig. 3; 17,7 cm	39
125 08 0150	Lžička ostrá fig. 5; 18,4 cm	Sharp spoon; fig. 5; 18,4 cm	39
125 08 0160	Lžička ostrá fig. 1; 16,5 cm	Sharp spoon; fig. 1; 16,5 cm	39
125 08 0170	Lžička ostrá fig. 2; 16,5 cm	Sharp spoon; fig. 2; 16,5 cm	39
125 08 0180	Lžička ostrá fig. 3; 17,5 cm	Sharp spoon; fig. 3; 17,5 cm	39
125 08 0190	Lžička ostrá fig. 4; 17,5 cm	Sharp spoon; fig. 4; 17,5 cm	39
125 08 0200	Lžička ostrá fig. 5; 19,5 cm	Sharp spoon; fig. 5; 19,5 cm	39
125 08 0210	Lžička ostrá fig. 6; 19,5 cm	Sharp spoon; fig. 6; 19,5 cm	39
125 50 0010	Lžička oboustranná; 17,0 cm	Bone curette double-faced; 17,0 cm	38
125 50 0050	Lžička oboustranná lomená ostrá; 2 mm; 17,0 cm	Bone curette double-faced; 2 mm; 17,0 cm	38
125 50 0060	Lžička oboustranná lomená ostrá; 3 mm; 17,0 cm	Bone curette double-faced; 3 mm; 17,0 cm	38
125 50 0070	Lžička oboustranná lomená ostrá; 4 mm; 17,0 cm	Bone curette double-faced; 4 mm; 17,0 cm	38
125 50 0090	Lžička oboustranná lomená ostrá; 6 mm; 17,0 cm	Bone curette double-faced; 6 mm; 17,0 cm	38
125 50 0100	Lžička exkochleální bajonetová pravá; 16,3 cm	Bone curette; 16,3 cm	40
125 50 0110	Lžička exkochleální bajonetová levá; 16,3 cm	Bone curette; 16,3 cm	40
125 51 0156	Lžička oboustranná ostrá; 1,5 mm; 16,6 cm	Bone curette double-faced; 1,5 mm; 16,6 cm	38
125 51 0166	Lžička oboustranná ostrá; 2,0 mm; 17,4 cm	Bone curette double-faced; 2,0 mm; 17,4 cm	38
125 51 0176	Lžička oboustranná ostrá; 2,5 mm; 16,6 cm	Bone curette double-faced; 2,5 mm; 16,6 cm	38
125 53 0010	Lžička laboratorní; 15,0 cm	Laboratory spoon; 15,0 cm	121
125 53 0020	Lžička laboratorní; 20,0 cm	Laboratory spoon; 20,0 cm	121
125 56 0066	Lžička ostrá oboustranná; 3,0 mm; 16,7 cm	Bone curette double-faced hollow handle; 3,0 mm; 16,7 cm	38
125 56 0156	Lžička ostrá oboustranná; 1,5 mm; 16,6 cm	Bone curette double-faced hollow handle; 1,5 mm; 16,6 cm	38
125 56 0166	Lžička ostrá oboustranná; 2,0 mm; 16,6 cm	Bone curette double-faced hollow handle; 2,0 mm; 16,6 cm	38
125 56 0176	Lžička ostrá oboustranná; 2,5 mm; 16,6 cm	Bone curette double-faced hollow handle; 2,5 mm; 16,6 cm	38
126	Kyrety	Curettes	
126 53 0010	Testovací tyčinka PMMA	Plastic test stick	105
126 58 0056	Gracey kyreta 1/2; 17,4 cm	Gracey curette 1/2; 17,4 cm	102, 104
126 58 0066	Gracey kyreta 3/4; 17,4 cm	Gracey curette 3/4; 17,4 cm	102, 104
126 58 0076	Gracey kyreta 5/6; 17,3 cm	Gracey curette 5/6; 17,3 cm	102, 104
126 58 0086	Gracey kyreta 7/8; 17,0 cm	Gracey curette 7/8; 17,0 cm	102, 104
126 58 0096	Scaler oboustranný; 16,7 cm	Scaler double-faced; 16,7 cm	104, 105
126 58 0106	Gracey kyreta 11/12; 17,2 cm	Gracey curette 11/12; 17,2 cm	102, 104
126 58 0116	Gracey kyreta 13/14; 17,0 cm	Gracey curette 13/14; 17,0 cm	102, 104
126 58 0126	Gracey kyreta 15/16; 17,1 cm	Gracey curette 15/16; 17,1 cm	102, 104
126 58 0136	Gracey kyreta 17/18; 15,6 cm	Gracey curette 17/18; 15,6 cm	102, 104
126 58 0146	Gracey kyreta 9/10; 16,5 cm	Gracey curette 9/10; 16,5 cm	102, 104
126 58 1056	Mini Gracey kyreta 1/2; 17,6 cm	Mini Gracey curette 1/2; 17,6 cm	103, 104
126 58 1066	Mini Gracey kyreta 3/4; 17,4 cm	Mini Gracey curette 3/4; 17,4 cm	103, 104
126 58 1076	Mini Gracey kyreta 5/6; 17,5 cm	Mini Gracey curette 5/6; 17,5 cm	103, 104
126 58 1086	Mini Gracey kyreta 7/8; 17,1 cm	Mini Gracey curette 7/8; 17,1 cm	103, 104
126 58 1106	Mini Gracey kyreta 11/12; 17,4 cm	Mini Gracey curette 11/12; 17,4 cm	103, 104
126 58 1116	Mini Gracey kyreta 13/14; 17,4 cm	Mini Gracey curette 13/14; 17,4 cm	103, 104
126 58 1126	Mini Gracey kyreta 15/16; 17,2 cm	Mini Gracey curette 15/16; 17,2 cm	103, 104

číslo – number	název	item	strana – page
126 58 1136	Mini Gracey kyreta 17/18; 15,8 cm	Mini Gracey curette 17/18; 15,8 cm	103, 104
126 58 1146	Mini Gracey kyreta 9/10; 16,7 cm	Mini Gracey curette 9/10; 16,7 cm	103, 104
126 91 0162	Obtahovací kamínek na ostření kyret	Sharpening stone for currettes	105
127	Pilky, Pilníky	Saws, Files	
127 08 0270	Pilník; 15,9 cm	Rasp; 15,9 cm	27
127 30 0100	Joseph pilník, fig. 1; 16,5 cm	Joseph rasp; fig. 1; 16,5 cm	27
127 30 0110	Joseph pilník, fig. 2; 16,5 cm	Joseph rasp; fig. 2; 16,5 cm	27
127 30 0120	Joseph pilník, fig. 3; 16,5 cm	Joseph rasp; fig. 3; 16,5 cm	27
127 30 0130	Joseph pilník, fig. 4; 16,5 cm	Joseph rasp; fig. 4; 16,5 cm	27
127 50 0001	List k pilce upínací stomatologické; 7,3 cm	Blade of stomatological saw; 7,3 cm	116
127 50 0150	Rám upínací pilky stomatologické; 19,0 cm	Frame of stomatological saw; 19,0 cm	116
127 51 1206	Pilník diamantovaný fig. 1; 2x8 mm; 15,0 cm	Diamond file; fig. 1; 2x8 mm; 15,0 cm	112
127 51 1216	Pilník diamantovaný fig. 2; 2x8 mm; 15,0 cm	Diamond file; fig. 2; 2x8 mm; 15,0 cm	112
127 51 1226	Pilník diamantovaný fig. 3; 2x8 mm; 15,2 cm	Diamond file; fig. 3; 2x8 mm; 15,2 cm	112
127 51 1236	Pilník diamantovaný fig. 4; 2x8 mm; 15,2 cm	Diamond file; fig. 4; 2x8 mm; 15,2 cm	112
127 51 1306	Pilník diamantovaný jehlový; 15,0 cm	Diamond file needle; 15,0 cm	112
127 51 1316	Pilník diamantovaný fig. 5; 2x8 mm; 15,0 cm	Diamond file; fig. 5; 2x8 mm; 15,0 cm	112
127 51 1326	Pilník diamantovaný fig. 6; 2x8 mm; 15,0 cm	Diamond file; fig. 6; 2x8 mm; 15,0 cm	112
127 51 1336	Pilník diamantovaný fig. 7; 2x8 mm; 15,0 cm	Diamond file; fig. 7; 2x8 mm; 15,0 cm	112
127 51 1346	Pilník diamantovaný fig. 8; 2x8 mm; 15,0 cm	Diamond file; fig. 8; 2x8 mm; 15,0 cm	112
128	Dláta, Kladiva	Chisels, Mallets	
128 08 0901	Kladívko chirurgické kovové; 250 g	Surgical mallet; 250 g	30
128 08 0911	Kladívko chirurgické kovové; 500 g	Surgical mallet; 500 g	30
128 30 0010	Dláto žlábkové; 180x2 mm	Gouge grooved; 180x2 mm	28
128 30 0030	Dláto žlábkové; 180x4 mm	Gouge grooved; 180x4 mm	28
128 30 0040	Dláto žlábkové; 180x5 mm	Gouge grooved; 180x5 mm	28
128 30 0200	West dláto žlábkové; 180x2 mm	West gouge grooved; 180x2 mm	28
128 30 0230	West dláto žlábkové; 180x5 mm	West gouge grooved; 180x5 mm	28
128 50 0050	Dláto ploché jemné; 175x3 mm	Chisel flat fine; 175x3 mm	28
128 50 0060	Dláto ploché jemné; 175x4 mm	Chisel flat fine; 175x4 mm	28
128 50 0070	Dláto ploché jemné; 175x5 mm	Chisel flat fine; 175x5 mm	28
128 50 0080	Dláto ploché jemné; 175x6 mm	Chisel flat fine; 175x6 mm	28
128 50 0110	Dláto poloklínové jemné; 175x3 mm	Chisel half-wedged fine; 175x3 mm	29
128 50 0120	Dláto poloklínové jemné; 175x4 mm	Chisel half-wedged fine; 175x4 mm	29
128 50 0130	Dláto poloklínové jemné; 175x5 mm	Chisel half-wedged fine; 175x5 mm	29
128 50 0140	Dláto poloklínové jemné; 175x6 mm	Chisel half-wedged fine; 175x6 mm	29
128 50 0200	Dláto žlábkové jemné; 175x3 mm	Gouge grooved fine; 175x3 mm	29
128 50 0210	Dláto žlábkové jemné; 175x4 mm	Gouge grooved fine; 175x4 mm	29
128 50 0220	Dláto žlábkové jemné; 175x5 mm	Gouge grooved fine; 175x5 mm	29
128 50 0230	Dláto žlábkové jemné; 175x6 mm	Gouge grooved fine; 175x6 mm	29
128 52 0110	Kladívko laboratorní ocelové; 26,0 cm	Laboratory mallet; 26,0 cm	125
128 52 0111	Kladívko laboratorní ocelové; 26,0 cm	Laboratory mallet; 26,0 cm	125
129	Dlahy dentální	Dental Plates	
129 51 0100	Dlaha dentální prefabrikovaná; 15,2 cm	Prefabricated plate; 15,2 cm	54
132	Jehelce, Zavaděče	Needle Holders, Introducers	
132 06 0200	Mathieu jehelec bez drážky; 14,0 cm	Mathieu needle holder; 14,0 cm	50
132 06 0220	Mathieu jehelec bez drážky; 17,2 cm	Mathieu needle holder; 17,2 cm	50
132 06 0300	Crile jehelec jemný; 15,0 cm	Crile needle holder fine; 15,0 cm	50
132 06 0310	Crile jehelec jemný; 15,5 cm	Crile needle holder fine; 15,5 cm	50
132 06 0341	Jehelec hloubk. rovný provlékací zámek; 16,5 cm	Needle holder; 16,5 cm	50
132 06 0370	Crile jehelec jemný diamantovaný; 1,6 mm; 15,7 cm	Crile needle holder dia; 1,6 mm; 15,7 cm	52
132 06 0450	Crile jehelec jemný provlékací zámek (vločka sk); 16,2 cm	Crile needle holder TUC; 16,2 cm	52
132 06 0500	Mathieu jehelec provl. zámek (vločka SK); 17,2 cm	Mathieu needle holder TUC; 17,2 cm	52
132 06 0510	Mathieu jehelec provl. zámek (vločka SK); 21,5 cm	Mathieu needle holder TUC; 21,5 cm	52
132 06 0520	Mathieu jehelec provl. zámek (vločka SK); 14,0 cm	Mathieu needle holder TUC; 14,0 cm	52
132 06 0600	Ryder jehelec tvrdokov; 16,5 cm	Ryder needle holder TUC; 16,5 cm	51
132 06 0610	Jehelec hloubk. rovný (vločka SK) tvrdokov; 16,5 cm	Needle holder TUC; 16,5 cm	51
132 06 0640	Ryder jehelec tvrdokov; 20,5 cm	Ryder needle holder TUC; 20,5 cm	51
132 06 0650	Ryder jehelec tvrdokov; 25,5 cm	Ryder needle holder TUC; 25,5 cm	51
132 06 0810	Jehelec s vnitřním uzávěrem vroubk.; 20,5 cm	Needle holder; 20,5 cm	50
132 38 0120	Boynton jehelec oční; 12,5 cm	Boynton eye needle holder; 12,5 cm	50
132 50 0180	Luniatschek zavaděč drenů; 17,0 cm	Luniatschek drain introducer; 17,0 cm	54
132 50 0186	Luniatschek zavaděč drenů; 16,7 cm	Luniatschek drain introducer; 16,7 cm	54
132 50 0196	Luniatschek zavaděč drenů se žlábkem; 16,7 cm	Luniatschek drain introducer with groove; 16,7 cm	54
132 56 0186	Luniatschek zavaděč drenů; 16,8 cm	Luniatschek drain introducer hollow handle; 16,8 cm	54
132 56 0196	Luniatschek zavaděč drenů se žlábkem; 16,8 cm	Luniatschek drain introducer hollow handle; 16,8 cm	54
132 91 0056	Mathieu jehelec bez drážky; 20,0 cm	Mathieu needle holder; 20,0 cm	50
132 91 0057	Mathieu jehelec bez drážky; 24,0 cm	Mathieu needle holder; 24,0 cm	50
132 91 0160	Olsen-Hegar jehelec/nůžky tvrdokov; 14,0 cm	Olsen-Hegar needle holder/scs. TUC; 14,0 cm	51

číslo – number	název	item	strana – page
132 91 0161	Olsen-Hegar jehelec/nůžky tvrdokov; 17,0 cm	Olsen-Hegar needle holder/scs. TUC; 17,0 cm	51
132 91 0162	Olsen-Hegar jehelec/nůžky tvrdokov; 19,0 cm	Olsen-Hegar needle holder/scs. TUC; 19,0 cm	51
132 91 0168	Mathieu jehelec jemný tvrdokov; 17,0 cm	Mathieu needle holder TUC; 17,0 cm	52
132 91 0169	Mathieu jehelec jemný tvrdokov; 20,0 cm	Mathieu needle holder TUC; 20,0 cm	52
132 91 0170	Mathieu jehelec jemný tvrdokov; 23,0 cm	Mathieu needle holder TUC; 23,0 cm	52
132 91 0182	Boynton jehelec oční tvrdokov; 12,5 cm	Boynton eye needle holder; 12,5 cm	52
132 91 0215	Castroviejo jehelec rovný vroubkovaný tvrdokov; 14,0 cm	Castroviejo needle holder TUC; 14,0 cm	53
132 91 0216	Castroviejo jehelec zahnutý vroubkovaný tvrdokov; 14,0 cm	Castroviejo needle holder TUC; 14,0 cm	53
132 91 0219	Castroviejo jehelec rovný vroubkovaný tvrdokov; 18,0 cm	Castroviejo micro-needle holder TUC; 18,0 cm	53
132 91 0220	Castroviejo jehelec zahnutý vroubkovaný tvrdokov; 18,0 cm	Castroviejo micro-needle holder TUC; 18,0 cm	53
132 91 0221	Jacobson jehelec mikro hladký tvrdokov; 21,0 cm	Jacobson micro-needle holder TUC; 21,0 cm	53
132 91 0222	Jacobson jehelec mikro vroubkovaný tvrdokov; 21,0 cm	Jacobson micro-needle holder TUC; 21,0 cm	53
132 91 0257	Castroviejo jehelec mikro rovný hladký; 14,0 cm	Castroviejo micro-needle holder; 14,0 cm	53
132 91 0258	Castroviejo jehelec mikro zahnutý hladký; 14,0 cm	Castroviejo micro-needle holder; 14,0 cm	53
132 91 0259	Castroviejo jehelec mikro rovný vroubkovaný; 14,0 cm	Castroviejo micro-needle holder; 14,0 cm	53
132 91 0260	Castroviejo jehelec mikro zahnutý vroubkovaný; 14,0 cm	Castroviejo micro-needle holder; 14,0 cm	53
132 91 0261	Castroviejo jehelec rovný hladký s uzávěrem; 14,0 cm	Castroviejo micro-needle holder; 14,0 cm	53
132 91 0262	Castroviejo jehelec zahnutý hladký s uzávěrem; 14,0 cm	Castroviejo micro-needle holder; 14,0 cm	53
132 91 0263	Castroviejo jehelec rovný vroubk. s uzávěrem; 14,0 cm	Castroviejo micro-needle holder; 14,0 cm	53
132 91 0264	Castroviejo jehelec zahnutý vroubk. s uzávěrem; 14,0 cm	Castroviejo micro-needle holder; 14,0 cm	53
133	Sondy, pátradla	Probes	
133 38 0060	Bowmann pátradlo oční nerez; 0,5 mm; 13,0 cm	Bowmann eye probe; 0,5 mm; 13,0 cm	73
133 38 0070	Bowmann pátradlo oční nerez; 0,7 mm; 13,0 cm	Bowmann eye probe; 0,7 mm; 13,0 cm	73
133 38 0080	Bowmann pátradlo oční nerez; 0,9 mm; 13,0 cm	Bowmann eye probe; 0,9 mm; 13,0 cm	73
133 50 0106	Sonda parodontolog. 3,5; 5,5; 8,5; 11,5 mm; 15,2 cm	Periodontal probe; 3,5; 5,5; 8,5; 11,5 mm; 15,2 cm	101
133 50 0116	Sonda parodontolog. 1; 2; 3; 5; 7; 9; 11; 13 mm; 15,2 cm	Periodontal probe; 2; 3; 5; 7; 9; 11; 13 mm; 15,2 cm	101
133 51 0010	Pátradlo zubní háčkové krátké; 15,2 cm	Dental probe short hooked; 15,2 cm	73
133 51 0016	Pátradlo zubní háčkové krátké; 15,2 cm	Dental probe short hooked; 15,2 cm	73
133 51 0020	Pátradlo zubní háčkové dlouhé; 15,1 cm	Dental probe long hooked; 15,1 cm	73
133 51 0026	Pátradlo zubní háčkové dlouhé; 15,1 cm	Dental probe long hooked; 15,1 cm	73
133 51 0030	Pátradlo zubní obloukové; 14,5 cm	Dental probe embowed; 14,5 cm	73
133 51 0036	Pátradlo zubní obloukové; 14,5 cm	Dental probe embowed; 14,5 cm	73
133 51 0040	Pátradlo zubní vyhnuté krátké; 15,0 cm	Dental probe short angled; 15,0 cm	73
133 51 0046	Pátradlo zubní vyhnuté krátké; 15,0 cm	Dental probe short angled; 15,0 cm	73
133 51 0050	Pátradlo zubní vyhnuté dlouhé; 14,0 cm	Dental probe long angled; 14,0 cm	73, 76
133 51 0056	Pátradlo zubní vyhnuté dlouhé; 14,0 cm	Dental probe long angled; 14,0 cm	73
133 51 0226	Explorer; 15,5 cm	Explorer; 15,5 cm	101
133 56 0016	Pátradlo zubní háčkové krátké; 16,3 cm	Dental probe short hooked hollow handle; 16,3 cm	73
133 56 0026	Pátradlo zubní háčkové dlouhé; 16,2 cm	Dental probe long hooked hollow handle; 16,2 cm	73
133 56 0036	Pátradlo zubní obloukové; 15,6 cm	Dental probe embowed hollow handle; 15,6 cm	73
133 56 0046	Pátradlo zubní vyhnuté krátké; 16,1 cm	Dental probe short angled hollow handle; 16,1 cm	73
133 56 0056	Pátradlo zubní vyhnuté dlouhé; 15,1 cm	Dental probe long angled hollow handle; 15,1 cm	73
133 58 0230	Nabers furkační sonda 3-6-9-12; 17,2 cm	Nabers furcation probe 3-6-9-12; 17,2 cm	101
133 99 0177	Sonda parodontologická s pátradlem; 15,7 cm	Periodontal and dental probe; 15,7 cm	101
133 99 0186	Pátradlo zubní obloukové, háčkové krátké; 15,7 cm	Dental probe embowed, short hooked; 15,7 cm	73
136	Nástroje speciální	Special Instruments	
136 39 0010	Toulec na pinzety; 9,0 cm	Quiver for tweezers; 9,0 cm	134
136 39 0020	Toulec na podávkové kleště; 20,0 cm	Quiver for forceps; 20,0 cm	134
136 39 0030	Toulec na pinzety; 9,0 cm	Quiver for tweezers; 9,0 cm	134
136 39 0040	Toulec na podávkové kleště; 20,0 cm	Quiver for forceps; 20,0 cm	134
136 39 0050	Toulec na pinzety s podstavcem; 11,0 cm	Tweezer quiver with stand; 11,0 cm	134
136 39 0060	Toulec na kleště s podstavcem; 20,0 cm	Forceps quiver with stand; 20,0 cm	134
136 39 0070	Toulec na pinzety s podstavcem; 9,0 cm	Tweezer quiver with stand; 9,0 cm	134
136 39 0110	Táček dentální; 180×120×15 mm	Dental tray; 180×120×15 mm	137
136 39 0140	Krabička sterilizační; nerez; 200×100×30 mm	Sterilization box; 200×100×30 mm	136
136 39 0150	Krabička sterilizační; nerez; 170×70×30 mm	Sterilization box; 170×70×30 mm	136
136 39 0160	Krabička sterilizační; nerez; 200×100×40 mm	Sterilization box; 200×100×40 mm	136
136 39 0170	Krabička s rovným víkem/úch.; nerez; 210×115×45 mm	Box; 210×115×45 mm	136
136 39 0180	Krabička s příhrádkami dvojí víčko; 210×110×25 mm	Box; 210×110×25 mm	136
136 39 0190	Krabička s vypouklým víčkem; 210×115×45 mm	Box; 210×115×45 mm	136
136 39 0200	Krabička na katetry, víčko s úch.; nerez; 300×80×40 mm	Box; 300×80×40 mm	136
136 39 0210	Krabička s bočními prohlubněmi; nerez; 92×40×17 mm	Box; 92×40×17 mm	137
136 39 0211	Krabička kulatá; nerez; 65×15 mm	Box round; 65×15 mm	135
136 39 0212	Krabička kulatá perforovaná; nerez; 62×13 mm	Box round perforated; 62×13 mm	135
136 39 0213	Krabička kulatá; nerez; 40×13 mm	Box round; 40×13 mm	135
136 39 0214	Krabička kulatá; nerez; 80×18 mm	Box round; 80×18 mm	135
136 39 0215	Krabička kulatá; nerez; 90×20 mm	Box round; 90×20 mm	135
136 39 0216	Krabička kulatá; nerez; 100×20 mm	Box round; 100×20 mm	135
136 39 0220	Krabička s poklopem a úchytem; nerez; 350×90×50 mm	Box; 350×90×50 mm	136

číslo – number	název	item	strana – page
136 39 0230	Krabička s poklopem a úchytem; nerez; 230×150×60 mm	Box; 230×150×60 mm	136
136 39 0240	Krabička s poklopem a rov.úch.; nerez; 300×200×50 mm	Box; 300×200×50 mm	136
136 39 0250	Krabička s poklopem a rov. úch.; nerez; 200×150×45 mm	Box; 200×150×45 mm	136
136 39 0260	Nádobka oválná – emitní miska; nerez; 175×100×25 mm	Bowl; 175×100×25 mm	135
136 39 0270	Nádobka kovová; nerez; 90×40 mm	Bowl; 90×40 mm	135
136 39 0320	Nádobka medicínská kovová; 82×30 mm	Bowl; 82×30 mm	135
136 39 0330	Tácek; nerez; 200×100×10 mm	Tray; 200×100×10 mm	137
136 39 0340	Tácek s drážkami; nerez; 180×90×15 mm	Tray; 180×90×15 mm	137
136 39 0350	Tácek hluboký; nerez; 200×100×30 mm	Tray; 200×100×30 mm	137
136 39 0360	Tácek; nerez; 190×100×10 mm	Tray; 190×100×10 mm	137
136 39 0370	Tácek; nerez; 280×180×25 mm	Tray; 280×180×25 mm	137
136 39 0380	Tácek; nerez; 350×250×25 mm	Tray; 350×250×25 mm	137
136 39 0410	Krabička na umělý chrup; 80×80×40 mm	Box for denture; 80×80×40 mm	137
136 91 0001	Langenbeck chránič prstu	Langenbeck finger protector	36
136 91 0002	Langenbeck chránič prstu	Langenbeck finger protector	36
136 91 0003	Langenbeck chránič prstu	Langenbeck finger protector	36
136 91 0259	Kontejner; 285×280×100 mm; stříbrný	Container; 285×280×100 mm; silver	140
136 91 0260	Kontejner; 285×280×100 mm; modrý	Container; 285×280×100 mm; blue	140
136 91 0261	Kontejner; 285×280×100 mm; červený	Container; 285×280×100 mm; red	140
136 91 0262	Kontejner; 285×280×100 mm; zelený	Container; 285×280×100 mm; green	140
136 91 0263	Kontejner; 285×280×100 mm; zlatý	Container; 285×280×100 mm; gold	140
136 91 0264	Kontejner; 285×280×100 mm; černý	Container; 285×280×100 mm; black	140
136 91 0265	Kontejner; 285×280×135 mm; stříbrný	Container; 285×280×135 mm; silver	140
136 91 0266	Kontejner; 285×280×135 mm; modrý	Container; 285×280×135 mm; blue	140
136 91 0267	Kontejner; 285×280×135 mm; červený	Container; 285×280×135 mm; red	140
136 91 0268	Kontejner; 285×280×135 mm; zelený	Container; 285×280×135 mm; green	140
136 91 0269	Kontejner; 285×280×135 mm; zlatý	Container; 285×280×135 mm; gold	140
136 91 0270	Kontejner; 285×280×135 mm; černý	Container; 285×280×135 mm; black	140
136 91 0271	Kontejner; 285×280×150 mm; stříbrný	Container; 285×280×150 mm; silver	140
136 91 0272	Kontejner; 285×280×150 mm; modrý	Container; 285×280×150 mm; blue	140
136 91 0273	Kontejner; 285×280×150 mm; červený	Container; 285×280×150 mm; red	140
136 91 0274	Kontejner; 285×280×150 mm; zelený	Container; 285×280×150 mm; green	140
136 91 0275	Kontejner; 285×280×150 mm; zlatý	Container; 285×280×150 mm; gold	140
136 91 0276	Kontejner; 285×280×150 mm; černý	Container; 285×280×150 mm; black	140
136 91 0277	Kontejner; 285×280×200 mm; stříbrný	Container; 285×280×200 mm; silver	140
136 91 0278	Kontejner; 285×280×200 mm; modrý	Container; 285×280×200 mm; blue	140
136 91 0279	Kontejner; 285×280×200 mm; červený	Container; 285×280×200 mm; red	140
136 91 0280	Kontejner; 285×280×200 mm; zelený	Container; 285×280×200 mm; green	140
136 91 0281	Kontejner; 285×280×200 mm; stříbrný	Container; 285×280×200 mm; gold	140
136 91 0282	Kontejner; 285×280×200 mm; černý	Container; 285×280×200 mm; black	140
136 91 0283	Kontejner; 285×280×260 mm; stříbrný	Container; 285×280×260 mm; silver	140
136 91 0284	Kontejner; 285×280×260 mm; modrý	Container; 285×280×260 mm; blue	140
136 91 0285	Kontejner; 285×280×260 mm; červený	Container; 285×280×260 mm; red	140
136 91 0286	Kontejner; 285×280×260 mm; zelený	Container; 285×280×260 mm; green	140
136 91 0287	Kontejner; 285×280×260 mm; zlatý	Container; 285×280×260 mm; gold	140
136 91 0288	Kontejner; 285×280×260 mm; černý	Container; 285×280×260 mm; black	140
136 91 0337	Kontejner; 285×280×100 mm; stříbrný	Container; 285×280×100 mm; silver	140
136 91 0338	Kontejner; 285×280×100 mm; modrý	Container; 285×280×100 mm; blue	140
136 91 0339	Kontejner; 285×280×100 mm; červený	Container; 285×280×100 mm; red	140
136 91 0340	Kontejner; 285×280×100 mm; zelený	Container; 285×280×100 mm; green	140
136 91 0341	Kontejner; 285×280×100 mm; zlatý	Container; 285×280×100 mm; gold	140
136 91 0342	Kontejner; 285×280×100 mm; černý	Container; 285×280×100 mm; black	140
136 91 0343	Kontejner; 285×280×135 mm; stříbrný	Container; 285×280×135 mm; silver	140
136 91 0344	Kontejner; 285×280×135 mm; modrý	Container; 285×280×135 mm; blue	140
136 91 0345	Kontejner; 285×280×135 mm; červený	Container; 285×280×135 mm; red	140
136 91 0346	Kontejner; 285×280×135 mm; zelený	Container; 285×280×135 mm; green	140
136 91 0347	Kontejner; 285×280×135 mm; zlatý	Container; 285×280×135 mm; gold	140
136 91 0348	Kontejner; 285×280×135 mm; černý	Container; 285×280×135 mm; black	140
136 91 0349	Kontejner; 285×280×150 mm; stříbrný	Container; 285×280×150 mm; silver	140
136 91 0350	Kontejner; 285×280×150 mm; modrý	Container; 285×280×150 mm; blue	140
136 91 0351	Kontejner; 285×280×150 mm; červený	Container; 285×280×150 mm; red	140
136 91 0352	Kontejner; 285×280×150 mm; zelený	Container; 285×280×150 mm; green	140
136 91 0353	Kontejner; 285×280×150 mm; zlatý	Container; 285×280×150 mm; gold	140
136 91 0354	Kontejner; 285×280×150 mm; černý	Container; 285×280×150 mm; black	140
136 91 0355	Kontejner; 285×280×200 mm; stříbrný	Container; 285×280×200 mm; silver	140
136 91 0356	Kontejner; 285×280×200 mm; modrý	Container; 285×280×200 mm; blue	140
136 91 0357	Kontejner; 285×280×200 mm; červený	Container; 285×280×200 mm; red	140
136 91 0358	Kontejner; 285×280×200 mm; zelený	Container; 285×280×200 mm; green	140
136 91 0359	Kontejner; 285×280×200 mm; zlatý	Container; 285×280×200 mm; gold	140

číslo – number	název	item	strana – page
136 91 0360	Kontejner; 285×280×200 mm; černý	Container; 285×280×200 mm; black	140
136 91 0361	Kontejner; 285×280×260 mm; stříbrný	Container; 285×280×260 mm; silver	140
136 91 0362	Kontejner; 285×280×260 mm; modrý	Container; 285×280×260 mm; blue	140
136 91 0363	Kontejner; 285×280×260 mm; červený	Container; 285×280×260 mm; red	140
136 91 0364	Kontejner; 285×280×260 mm; zelený	Container; 285×280×260 mm; green	140
136 91 0365	Kontejner; 285×280×260 mm; zlatý	Container; 285×280×260 mm; gold	140
136 91 0366	Kontejner; 285×280×260 mm; černý	Container; 285×280×260 mm; black	140
136 91 0415	Víko perforované; 285×280 mm; stříbrné	Lid perforated; 285×280 mm; silver	140
136 91 0416	Víko perforované; 285×280 mm; modré	Lid perforated; 285×280 mm; blue	140
136 91 0417	Víko perforované; 285×280 mm; červené	Lid perforated; 285×280 mm; red	140
136 91 0418	Víko perforované; 285×280 mm; zelené	Lid perforated; 285×280 mm; green	140
136 91 0419	Víko perforované; 285×280 mm; zlaté	Lid perforated; 285×280 mm; gold	140
136 91 0420	Víko perforované; 285×280 mm; černé	Lid perforated; 285×280 mm; black	140
136 91 0438	Víko ochranné; 285×280 mm; stříbrné	Safety lid; 285×280 mm; silver	140
136 91 0439	Víko ochranné; 285×280 mm; modré	Safety lid; 285×280 mm; blue	140
136 91 0440	Víko ochranné; 285×280 mm; červené	Safety lid; 285×280 mm; red	140
136 91 0441	Víko ochranné; 285×280 mm; zelené	Safety lid; 285×280 mm; green	140
136 91 0442	Víko ochranné; 285×280 mm; zlaté	Safety lid; 285×280 mm; gold	140
136 91 0443	Víko ochranné; 285×280 mm; černé	Safety lid; 285×280 mm; black	140
136 91 0463	Vana perforovaná; 285×280×100 mm	Bottom perforated; 285×280×100 mm	140
136 91 0464	Vana perforovaná; 285×280×135 mm	Bottom perforated; 285×280×135 mm	140
136 91 0465	Vana perforovaná; 285×280×150 mm	Bottom perforated; 285×280×150 mm	140
136 91 0466	Vana perforovaná; 285×280×200 mm	Bottom perforated; 285×280×200 mm	140
136 91 0467	Vana perforovaná; 285×280×260 mm	Bottom perforated; 285×280×260 mm	140
136 91 0475	Vana neperforovaná; 285×280×100 mm	Bottom non-perforated; 285×280×100 mm	140
136 91 0476	Vana neperforovaná; 285×280×135 mm	Bottom non-perforated; 285×280×135 mm	140
136 91 0477	Vana neperforovaná; 285×280×150 mm	Bottom non-perforated; 285×280×150 mm	140
136 91 0478	Vana neperforovaná; 285×280×200 mm	Bottom non-perforated; 285×280×200 mm	140
136 91 0479	Vana neperforovaná; 285×280×260 mm	Bottom non-perforated; 285×280×260 mm	140
136 91 0485	Víko perforované; 300×140 mm; stříbrné	Lid perforated; 300×140 mm; silver	142
136 91 0486	Víko perforované; 300×140 mm; modré	Lid perforated; 300×140 mm; blue	142
136 91 0487	Víko perforované; 300×140 mm; červené	Lid perforated; 300×140 mm; red	142
136 91 0488	Víko perforované; 300×140 mm; zelené	Lid perforated; 300×140 mm; green	142
136 91 0489	Víko perforované; 300×140 mm; zlaté	Lid perforated; 300×140 mm; gold	142
136 91 0490	Víko neperforované; 285×280 mm; stříbrné	Lid non-perforated; 285×280 mm; silver	140
136 91 0491	Víko neperforované; 285×280 mm; modré	Lid non-perforated; 285×280 mm; blue	140
136 91 0492	Víko neperforované; 285×280 mm; červené	Lid non-perforated; 285×280 mm; red	140
136 91 0493	Víko neperforované; 285×280 mm; zelené	Lid non-perforated; 285×280 mm; green	140
136 91 0494	Víko neperforované; 285×280 mm; zlaté	Lid non-perforated; 285×280 mm; gold	140
136 91 0495	Víko neperforované; 285×280 mm; černé	Lid non-perforated; 285×280 mm; black	140
136 91 0513	Víko neperforované; 300×140 mm; stříbrné	Lid non-perforated; 300×140 mm; silver	142
136 91 0514	Víko neperforované; 300×140 mm; modré	Lid non-perforated; 300×140 mm; blue	142
136 91 0515	Víko neperforované; 300×140 mm; červené	Lid non-perforated; 300×140 mm; red	142
136 91 0516	Víko neperforované; 300×140 mm; zelené	Lid non-perforated; 300×140 mm; green	142
136 91 0517	Víko neperforované; 300×140 mm; zlaté	Lid non-perforated; 300×140 mm; gold	142
136 91 0526	Koš síťový; 255×245×30 mm	Wire basket; 255×245×30 mm	140
136 91 0527	Koš síťový; 255×245×50 mm	Wire basket; 255×245×50 mm	140
136 91 0528	Koš síťový; 255×245×70 mm	Wire basket; 255×245×70 mm	140
136 91 0529	Koš síťový; 255×245×100 mm	Wire basket; 255×245×100 mm	140
136 91 0534	Filtr standardní papírový; 100 ks	Paper filters standard; 100 pieces	143
136 91 0535	Filtr standardní textilní; 1 ks	Textile filter standard; 1 piece	143
136 91 0536	Filtr mini papírový; 100 ks	Paper filters small; 100 pieces	143
136 91 0537	Filtr mini textilní; 1 ks	Textile filter mini; 1 piece	143
136 91 0540	Štítek identifikační papírový standardní; 100 ks	Paper label with indicator; 100 pieces	143
136 91 0541	Štítek identifikační papírový malý; 100 ks	Paper label with indicator; 100 pieces	143
136 91 0542	Zámek bezpečnostní plastový; 100 ks	Plastic security seal; 100 pieces	143
136 91 0543	Štítek identifikační; stříbrný	Identification label blank; silver	143
136 91 0544	Štítek identifikační; zlatý	Identification label blank; golden	143
136 91 0545	Štítek identifikační; červený	Identification label blank; red	143
136 91 0546	Štítek identifikační; modrý	Identification label blank; blue	143
136 91 0547	Štítek identifikační; zelený	Identification label blank; green	143
136 91 0548	Štítek identifikační; černý	Identification label blank; black	143
136 91 0550	Štítek identifikační pro text; stříbrný	Identification label engrave; silver	143
136 91 0551	Štítek identifikační pro text; zlatý	Identification label engrave; golden	143
136 91 0552	Štítek identifikační pro text; červený	Identification label engrave; red	143
136 91 0553	Štítek identifikační pro text; modrý	Identification label engrave; blue	143
136 91 0554	Štítek identifikační pro text; zelený	Identification label engrave; green	143
136 91 0555	Štítek identifikační pro text; černý	Identification label engrave; black	143
136 91 0569	Kontejner mini; 300×140×40 mm; stříbrný	Small set container; 300×140×40 mm; silver	142

číslo – number	název	item	strana – page
136 91 0570	Kontejner mini; 300×140×40 mm; modrý	Small set container; 300×140×40 mm; blue	142
136 91 0571	Kontejner mini; 300×140×40 mm; červený	Small set container; 300×140×40 mm; red	142
136 91 0572	Kontejner mini; 300×140×40 mm; zelený	Small set container; 300×140×40 mm; green	142
136 91 0573	Kontejner mini; 300×140×40 mm; zlatý	Small set container; 300×140×40 mm; gold	142
136 91 0574	Kontejner mini; 300×140×70 mm; stříbrný	Small set container; 300×140×70 mm; silver	142
136 91 0575	Kontejner mini; 300×140×70 mm; modrý	Small set container; 300×140×70 mm; blue	142
136 91 0576	Kontejner mini; 300×140×70 mm; červený	Small set container; 300×140×70 mm; red	142
136 91 0577	Kontejner mini; 300×140×70 mm; zelený	Small set container; 300×140×70 mm; green	142
136 91 0578	Kontejner mini; 300×140×70 mm; zlatý	Small set container; 300×140×70 mm; gold	142
136 91 0579	Kontejner mini; 300×140×100 mm; stříbrný	Small set container; 300×140×100 mm; silver	142
136 91 0580	Kontejner mini; 300×140×100 mm; modrý	Small set container; 300×140×100 mm; blue	142
136 91 0581	Kontejner mini; 300×140×100 mm; červený	Small set container; 300×140×100 mm; red	142
136 91 0582	Kontejner mini; 300×140×100 mm; zelený	Small set container; 300×140×100 mm; green	142
136 91 0583	Kontejner mini; 300×140×100 mm; zlatý	Small set container; 300×140×100 mm; gold	142
136 91 0584	Kontejner mini; 300×140×40 mm; stříbrný	Small set container; 300×140×40 mm; silver	142
136 91 0585	Kontejner mini; 300×140×40 mm; modrý	Small set container; 300×140×40 mm; blue	142
136 91 0586	Kontejner mini; 300×140×40 mm; červený	Small set container; 300×140×40 mm; red	142
136 91 0587	Kontejner mini; 300×140×40 mm; zelený	Small set container; 300×140×40 mm; green	142
136 91 0588	Kontejner mini; 300×140×40 mm; zlatý	Small set container; 300×140×40 mm; gold	142
136 91 0589	Kontejner mini; 300×140×70 mm; stříbrný	Small set container; 300×140×70 mm; silver	142
136 91 0590	Kontejner mini; 300×140×70 mm; modrý	Small set container; 300×140×70 mm; blue	142
136 91 0591	Kontejner mini; 300×140×70 mm; červený	Small set container; 300×140×70 mm; red	142
136 91 0592	Kontejner mini; 300×140×70 mm; zelený	Small set container; 300×140×70 mm; green	142
136 91 0593	Kontejner mini; 300×140×70 mm; zlatý	Small set container; 300×140×70 mm; gold	142
136 91 0594	Kontejner mini; 300×140×100 mm; stříbrný	Small set container; 300×140×100 mm; silver	142
136 91 0595	Kontejner mini; 300×140×100 mm; modrý	Small set container; 300×140×100 mm; blue	142
136 91 0596	Kontejner mini; 300×140×100 mm; červený	Small set container; 300×140×100 mm; red	142
136 91 0597	Kontejner mini; 300×140×100 mm; zelený	Small set container; 300×140×100 mm; green	142
136 91 0598	Kontejner mini; 300×140×100 mm; zlatý	Small set container; 300×140×100 mm; gold	142
136 91 0599	Vana perforovaná; 300×140×40 mm	Bottom perforated; 300×140×40 mm	142
136 91 0600	Vana perforovaná; 300×140×70 mm	Bottom perforated; 300×140×70 mm	142
136 91 0601	Vana perforovaná; 300×140×100 mm	Bottom perforated; 300×140×100 mm	142
136 91 0602	Vana neperforovaná; 300×140×40 mm	Bottom non-perforated; 300×140×40 mm	142
136 91 0603	Vana neperforovaná; 300×140×70 mm	Bottom non-perforated; 300×140×70 mm	142
136 91 0604	Vana neperforovaná; 300×140×100 mm	Bottom non-perforated; 300×140×100 mm	142
136 91 0619	Rouška textilní zelená; 60×40 cm	Cloth green; 60×40 cm	144
136 91 0620	Rouška textilní zelená; 85×85 cm	Cloth green; 85×85 cm	144
136 91 0621	Rouška textilní zelená; 100×140 cm	Cloth green; 100×140 cm	144
136 91 0622	Rouška textilní zelená; 275×125 cm	Cloth green; 275×125 cm	144
136 91 0623	Rouška textilní zelená; 245×245 cm	Cloth green; 245×245 cm	144
136 91 0624	Podložka silikonová; 275×125 mm	Silicon mat; 275×125 mm	144
136 91 0625	Podložka silikonová; 225×225 mm	Silicon mat; 225×225 mm	144
136 91 0626	Podložka silikonová; 300×300 mm	Silicon mat; 300×300 mm	144
136 91 0630	Podložka silikonová; 440×230 mm	Silicon mat; 440×230 mm	144
136 91 0635	Filtr teflonový standardní; 1 ks	Teflon filter standard; 1 piece	141
136 91 0645	Víko perforované; 310×190 mm; stříbrné	Lid perforated; 310×190 mm; silver	141
136 91 0646	Víko perforované; 310×190 mm; modré	Lid perforated; 310×190 mm; blue	141
136 91 0647	Víko perforované; 310×190 mm; červené	Lid perforated; 310×190 mm; red	141
136 91 0648	Víko perforované; 310×190 mm; zelené	Lid perforated; 310×190 mm; green	141
136 91 0649	Víko perforované; 310×190 mm; zlaté	Lid perforated; 310×190 mm; gold	141
136 91 0650	Víko perforované; 310×190 mm; černé	Lid perforated; 310×190 mm; black	141
136 91 0652	Víko perforované; 300×140 mm; černé	Lid perforated; 300×140 mm; black	142
136 91 0653	Víko neperforované; 310×190 mm; stříbrné	Lid non perforated; 310×190 mm; silver	141
136 91 0654	Víko neperforované; 310×190 mm; modré	Lid non perforated; 310×190 mm; blue	141
136 91 0655	Víko neperforované; 310×190 mm; červené	Lid non perforated; 310×190 mm; red	141
136 91 0656	Víko neperforované; 310×190 mm; zelené	Lid non perforated; 310×190 mm; green	141
136 91 0657	Víko neperforované; 310×190 mm; zlaté	Lid non perforated; 310×190 mm; gold	141
136 91 0658	Víko neperforované; 310×190 mm; černé	Lid non perforated; 310×190 mm; black	141
136 91 0659	Víko neperforované; 300×140 mm; černé	Lid non perforated; 300×140 mm; black	142
136 91 0660	Vložka síťová; 270×125 mm	Wire base; 270×125 mm	142
136 91 0661	Koš síťový; 267×125×50 mm	Wire basket; 267×125×50 mm	142
136 91 0662	Koš síťový; 274×172×43 mm	Wire basket; 274×172×43 mm	141
136 91 0667	Rám napínací jednoduchý 255×255 mm	Drape retainer single 255×255 mm	140
136 91 0668	Rám napínací 255×255 mm	Drape retainer double 255×255 mm	140
136 91 0669	Rám napínací dentální; 270×170 mm	Drape retainer dental; 270×170 mm	141
136 91 0670	Rám napínací malý; 270×125 mm	Drape retainer small; 270×125 mm	142
136 91 0675	Síto oddělovací; 255×245×130 mm	Divider; 255×245×130 mm	140
136 91 0676	Filtr dentální papírový; 100 ks	Filter; paper; 100 pieces; dental	143
136 91 0677	Filtr dentální textilní; 1 ks	Filter; textile; 1 piece; dental	143

číslo – number	název	item	strana – page
136 91 0684	Kontejner mini; 300×140×40mm; černý	Small set container; 300×140×40mm; black	142
136 91 0685	Kontejner mini; 300×140×70mm; černý	Small set container; 300×140×70mm; black	142
136 91 0686	Kontejner mini; 300×140×100mm; černý	Small set container; 300×140×100mm; black	142
136 91 0687	Kontejner mini; 300×140×40mm; černý	Small set container; 300×140×40mm; black	142
136 91 0688	Kontejner mini; 300×140×70mm; černý	Small set container; 300×140×70mm; black	142
136 91 0689	Kontejner mini; 300×140×100mm; černý	Small set container; 300×140×100mm; black	142
136 91 0690	Vana perforovaná; 310×190×40 mm	Bottom perforated; 310×190×40 mm	141
136 91 0691	Vana perforovaná; 310×190×65 mm	Bottom perforated; 310×190×65 mm	141
136 91 0692	Vana perforovaná; 310×190×130 mm	Bottom perforated; 310×190×130 mm	141
136 91 0693	Vana neperforovaná; 310×190×40 mm	Bottom non perforated; 310×190×40 mm	141
136 91 0694	Vana neperforovaná; 310×190×65 mm	Bottom non perforated; 310×190×65 mm	141
136 91 0695	Vana neperforovaná; 310×190×130 mm	Bottom non perforated; 310×190×130 mm	141
136 91 0696	Kontejner dentální; 310×190×40 mm; stříbrný	Dental container; 310×190×40 mm; silver	141
136 91 0697	Kontejner dentální; 310×190×40 mm; modrý	Dental container; 310×190×40 mm; blue	141
136 91 0698	Kontejner dentální; 310×190×40 mm; červený	Dental container; 310×190×40 mm; red	141
136 91 0699	Kontejner dentální; 310×190×40 mm; zelený	Dental container; 310×190×40 mm; green	141
136 91 0700	Kontejner dentální; 310×190×40 mm; zlatý	Dental container; 310×190×40 mm; gold	141
136 91 0701	Kontejner dentální; 310×190×40 mm; černý	Dental container; 310×190×40 mm; black	141
136 91 0702	Kontejner dentální; 310×190×65 mm; stříbrný	Dental container; 310×190×65 mm; silver	141
136 91 0703	Kontejner dentální; 310×190×65 mm; modrý	Dental container; 310×190×65 mm; blue	141
136 91 0704	Kontejner dentální; 310×190×65 mm; červený	Dental container; 310×190×65 mm; red	141
136 91 0705	Kontejner dentální; 310×190×65 mm; zelený	Dental container; 310×190×65 mm; green	141
136 91 0706	Kontejner dentální; 310×190×65 mm; zlatý	Dental container; 310×190×65 mm; gold	141
136 91 0707	Kontejner dentální; 310×190×65 mm; černý	Dental container; 310×190×65 mm; black	141
136 91 0708	Kontejner dentální; 310×190×130 mm; stříbrný	Dental container; 310×190×130 mm; silver	141
136 91 0709	Kontejner dentální; 310×190×130 mm; modrý	Dental container; 310×190×130 mm; blue	141
136 91 0710	Kontejner dentální; 310×190×130 mm; červený	Dental container; 310×190×130 mm; red	141
136 91 0711	Kontejner dentální; 310×190×130 mm; zelený	Dental container; 310×190×130 mm; green	141
136 91 0712	Kontejner dentální; 310×190×130 mm; zlatý	Dental container; 310×190×130 mm; gold	141
136 91 0713	Kontejner dentální; 310×190×130 mm; černý	Dental container; 310×190×130 mm; black	141
136 91 0714	Kontejner dentální; 310×190×40 mm; stříbrný	Dental container; 310×190×40 mm; silver	141
136 91 0715	Kontejner dentální; 310×190×40 mm; modrý	Dental container; 310×190×40 mm; blue	141
136 91 0716	Kontejner dentální; 310×190×40 mm; červený	Dental container; 310×190×40 mm; red	141
136 91 0717	Kontejner dentální; 310×190×40 mm; zelený	Dental container; 310×190×40 mm; green	141
136 91 0718	Kontejner dentální; 310×190×40 mm; zlatý	Dental container; 310×190×40 mm; gold	141
136 91 0719	Kontejner dentální; 310×190×40 mm; černý	Dental container; 310×190×40 mm; black	141
136 91 0720	Kontejner dentální; 310×190×65 mm; stříbrný	Dental container; 310×190×65 mm; silver	141
136 91 0721	Kontejner dentální; 310×190×65 mm; modrý	Dental container; 310×190×65 mm; blue	141
136 91 0722	Kontejner dentální; 310×190×65 mm; červený	Dental container; 310×190×65 mm; red	141
136 91 0723	Kontejner dentální; 310×190×65 mm; zelený	Dental container; 310×190×65 mm; green	141
136 91 0724	Kontejner dentální; 310×190×65 mm; zlatý	Dental container; 310×190×65 mm; gold	141
136 91 0725	Kontejner dentální; 310×190×65 mm; černý	Dental container; 310×190×65 mm; black	141
136 91 0726	Kontejner dentální; 310×190×130 mm; stříbrný	Dental container; 310×190×130 mm; silver	141
136 91 0727	Kontejner dentální; 310×190×130 mm; modrý	Dental container; 310×190×130 mm; blue	141
136 91 0728	Kontejner dentální; 310×190×130 mm; červený	Dental container; 310×190×130 mm; red	141
136 91 0729	Kontejner dentální; 310×190×130 mm; zelený	Dental container; 310×190×130 mm; green	141
136 91 0730	Kontejner dentální; 310×190×130 mm; zlatý	Dental container; 310×190×130 mm; gold	141
136 91 0731	Kontejner dentální; 310×190×130 mm; černý	Dental container; 310×190×130 mm; black	141
136 91 0743	Filtr mini teflonový	Filter small teflon	141
136 91 1275	Buben sterilizační; 125×80 mm	Sterilization drum; 125×80 mm	139
136 91 1276	Buben sterilizační; 125×100 mm	Sterilization drum; 125×100 mm	139
136 91 1277	Buben sterilizační; 125×125 mm	Sterilization drum; 125×125 mm	139
136 91 1278	Buben sterilizační; 150×100 mm	Sterilization drum; 150×100 mm	139
136 91 1279	Buben sterilizační; 150×130 mm	Sterilization drum; 150×130 mm	139
136 91 1280	Buben sterilizační; 150×150 mm	Sterilization drum; 150×150 mm	139
136 91 1281	Buben sterilizační; 150×190 mm	Sterilization drum; 150×190 mm	139
136 91 1282	Buben sterilizační; 150×240 mm	Sterilization drum; 150×240 mm	139
136 91 1283	Buben sterilizační; 190×95 mm	Sterilization drum; 190×95 mm	139
136 91 1284	Buben sterilizační; 190×125 mm	Sterilization drum; 190×125 mm	139
136 91 1285	Buben sterilizační; 190×145 mm	Sterilization drum; 190×145 mm	139
136 91 1286	Buben sterilizační; 190×165 mm	Sterilization drum; 190×165 mm	139
136 91 1287	Buben sterilizační; 190×190 mm	Sterilization drum; 190×190 mm	139
136 91 1288	Buben sterilizační; 190×240 mm	Sterilization drum; 190×240 mm	139
136 91 1289	Buben sterilizační; 190×290 mm	Sterilization drum; 190×290 mm	139
136 91 1290	Buben sterilizační; 240×120 mm	Sterilization drum; 240×120 mm	139
136 91 1291	Buben sterilizační; 240×165 mm	Sterilization drum; 240×165 mm	139
136 91 1292	Buben sterilizační; 240×190 mm	Sterilization drum; 240×190 mm	139
136 91 1293	Buben sterilizační; 240×240 mm	Sterilization drum; 240×240 mm	139
136 91 1294	Buben sterilizační; 240×290 mm	Sterilization drum; 240×290 mm	139

číslo – number	název	item	strana – page
136 91 1295	Buben sterilizační; 290×120 mm	Sterilization drum; 290×120 mm	139
136 91 1296	Buben sterilizační; 290×145 mm	Sterilization drum; 290×145 mm	139
136 91 1297	Buben sterilizační; 290×165 mm	Sterilization drum; 290×165 mm	139
136 91 1298	Buben sterilizační; 290×190 mm	Sterilization drum; 290×190 mm	139
136 91 1299	Buben sterilizační; 290×240 mm	Sterilization drum; 290×240 mm	139
136 91 1300	Buben sterilizační; 290×290 mm	Sterilization drum; 290×290 mm	139
136 91 1301	Buben sterilizační; 340×120 mm	Sterilization drum; 340×120 mm	139
136 91 1302	Buben sterilizační; 340×145 mm	Sterilization drum; 340×145 mm	139
136 91 1303	Buben sterilizační; 340×165 mm	Sterilization drum; 340×165 mm	139
136 91 1304	Buben sterilizační; 340×190 mm	Sterilization drum; 340×190 mm	139
136 91 1305	Buben sterilizační; 340×240 mm	Sterilization drum; 340×240 mm	139
136 91 1306	Buben sterilizační; 340×290 mm	Sterilization drum; 340×290 mm	139
136 91 1307	Buben sterilizační; 390×140 mm	Sterilization drum; 390×140 mm	139
136 91 1308	Buben sterilizační; 390×165 mm	Sterilization drum; 390×165 mm	139
136 91 1309	Buben sterilizační; 390×190 mm	Sterilization drum; 390×190 mm	139
136 91 1310	Buben sterilizační; 390×240 mm	Sterilization drum; 390×240 mm	139
136 91 1311	Buben sterilizační; 390×290 mm	Sterilization drum; 390×290 mm	139
136 91 1312	Buben sterilizační; 390×340 mm	Sterilization drum; 390×340 mm	139
136 91 1313	Buben sterilizační; 390×390 mm	Sterilization drum; 390×390 mm	139
136 91 1314	Buben sterilizační; 125×80 mm	Sterilization drum; 125×80 mm	138
136 91 1315	Buben sterilizační; 125×100 mm	Sterilization drum; 125×100 mm	138
136 91 1316	Buben sterilizační; 125×125 mm	Sterilization drum; 125×125 mm	138
136 91 1317	Buben sterilizační; 150×80 mm	Sterilization drum; 150×80 mm	138
136 91 1318	Buben sterilizační; 150×100 mm	Sterilization drum; 150×100 mm	138
136 91 1319	Buben sterilizační; 150×130 mm	Sterilization drum; 150×130 mm	138
136 91 1320	Buben sterilizační; 150×150 mm	Sterilization drum; 150×150 mm	138
136 91 1321	Buben sterilizační; 150×190 mm	Sterilization drum; 150×190 mm	138
136 91 1322	Buben sterilizační; 150×240 mm	Sterilization drum; 150×240 mm	138
136 91 1323	Buben sterilizační; 190×95 mm	Sterilization drum; 190×95 mm	138
136 91 1324	Buben sterilizační; 190×125 mm	Sterilization drum; 190×125 mm	138
136 91 1325	Buben sterilizační; 190×145 mm	Sterilization drum; 190×145 mm	138
136 91 1326	Buben sterilizační; 190×165 mm	Sterilization drum; 190×165 mm	138
136 91 1327	Buben sterilizační; 190×190 mm	Sterilization drum; 190×190 mm	138
136 91 1328	Buben sterilizační; 190×240 mm	Sterilization drum; 190×240 mm	138
136 91 1329	Buben sterilizační; 190×290 mm	Sterilization drum; 190×290 mm	138
136 91 1330	Buben sterilizační; 240×95 mm	Sterilization drum; 240×95 mm	138
136 91 1331	Buben sterilizační; 240×120 mm	Sterilization drum; 240×120 mm	138
136 91 1332	Buben sterilizační; 240×145 mm	Sterilization drum; 240×145 mm	138
136 91 1333	Buben sterilizační; 240×165 mm	Sterilization drum; 240×165 mm	138
136 91 1334	Buben sterilizační; 240×190 mm	Sterilization drum; 240×190 mm	138
136 91 1335	Buben sterilizační; 240×240 mm	Sterilization drum; 240×240 mm	138
136 91 1336	Buben sterilizační; 240×290 mm	Sterilization drum; 240×290 mm	138
136 91 1337	Buben sterilizační; 240×340 mm	Sterilization drum; 240×340 mm	138
136 91 1338	Buben sterilizační; 240×390 mm	Sterilization drum; 240×390 mm	138
136 91 1339	Buben sterilizační; 290×120 mm	Sterilization drum; 290×120 mm	138
136 91 1340	Buben sterilizační; 290×145 mm	Sterilization drum; 290×145 mm	138
136 91 1341	Buben sterilizační; 290×165 mm	Sterilization drum; 290×165 mm	138
136 91 1342	Buben sterilizační; 290×190 mm	Sterilization drum; 290×190 mm	138
136 91 1343	Buben sterilizační; 290×240 mm	Sterilization drum; 290×240 mm	138
136 91 1344	Buben sterilizační; 290×290 mm	Sterilization drum; 290×290 mm	138
136 91 1345	Buben sterilizační; 290×340 mm	Sterilization drum; 290×340 mm	138
136 91 1346	Buben sterilizační; 290×390 mm	Sterilization drum; 290×390 mm	138
136 91 1347	Buben sterilizační; 340×120 mm	Sterilization drum; 340×120 mm	138
136 91 1348	Buben sterilizační; 340×145 mm	Sterilization drum; 340×145 mm	138
136 91 1349	Buben sterilizační; 340×165 mm	Sterilization drum; 340×165 mm	138
136 91 1350	Buben sterilizační; 340×190 mm	Sterilization drum; 340×190 mm	138
136 91 1351	Buben sterilizační; 340×240 mm	Sterilization drum; 340×240 mm	138
136 91 1352	Buben sterilizační; 340×290 mm	Sterilization drum; 340×290 mm	138
136 91 1353	Buben sterilizační; 340×340 mm	Sterilization drum; 340×340 mm	138
136 91 1354	Buben sterilizační; 340×390 mm	Sterilization drum; 340×390 mm	138
136 91 1355	Buben sterilizační; 390×140 mm	Sterilization drum; 390×140 mm	138
136 91 1356	Buben sterilizační; 390×165 mm	Sterilization drum; 390×165 mm	138
136 91 1357	Buben sterilizační; 390×190 mm	Sterilization drum; 390×190 mm	138
136 91 1358	Buben sterilizační; 390×240 mm	Sterilization drum; 390×240 mm	138
136 91 1359	Buben sterilizační; 390×290 mm	Sterilization drum; 390×290 mm	138
136 91 1360	Buben sterilizační; 390×340 mm	Sterilization drum; 390×340 mm	138
136 91 1361	Buben sterilizační; 390×390 mm	Sterilization drum; 390×390 mm	138
136 91 1362	Buben sterilizační; 390×490 mm	Sterilization drum; 390×490 mm	138
136 91 1363	Buben sterilizační; 390×590 mm	Sterilization drum; 390×590 mm	138

číslo – number	název	item	strana – page
136 91 1364	Buben sterilizační; 480×165 mm	Sterilization drum; 480×165 mm	138
136 91 1365	Buben sterilizační; 480×190 mm	Sterilization drum; 480×190 mm	138
136 91 1366	Buben sterilizační; 480×240 mm	Sterilization drum; 480×240 mm	138
136 91 1367	Buben sterilizační; 480×290 mm	Sterilization drum; 480×290 mm	138
136 91 1368	Buben sterilizační; 480×340 mm	Sterilization drum; 480×340 mm	138
136 91 1369	Buben sterilizační; 480×390 mm	Sterilization drum; 480×390 mm	138
136 91 1389	Podložka silikonová; 500×210 mm	Silicon mat; 500×210 mm	144
136 91 1390	Filtr látkový ke sterilizačnímu bubnu 125, 150; Ø 85 mm	Textile filter for sterilization drum 125, 150; Ø 85 mm	139
136 91 1391	Filtr látkový ke sterilizačnímu bubnu 190; Ø 100 mm	Textile filter for sterilization drum 190; Ø 100 mm	139
136 91 1392	Filtr látkový ke sterilizačnímu bubnu 240; Ø 140 mm	Textile filter for sterilization drum 240; Ø 140 mm	139
136 91 1393	Filtr látkový ke sterilizačnímu bubnu 290; Ø 180 mm	Textile filter for sterilization drum 290; Ø 180 mm	139
136 91 1394	Filtr látkový ke sterilizačnímu bubnu 340; Ø 225 mm	Textile filter for sterilization drum 340; Ø 225 mm	139
136 91 1395	Filtr látkový ke sterilizačnímu bubnu 390×140; Ø 270 mm	Textile filter for sterilization drum 390×140; Ø 270 mm	139
136 91 1396	Filtr látkový ke sterilizačnímu bubnu >390×165; Ø 310 mm	Textile filter for sterilization drum >390×165; Ø 310 mm	139
139	Stomatologické soubory	Stomatological Sets	
139 50 0120	Soubor základních stomatologických nástrojů malý	Set of basic stomatological instruments small	76
139 50 0150	Držák	Holder	76, 135
139 50 0160	Kazeta s držákem	Cassette with holder	135
139 50 0170	Kazeta pro stomatologické nástroje	Cassette	76, 135
139 50 0360	Soubor pro zubní techniky	Set for dental technicians	122
139 50 0770	Soubor parodontologických nástrojů, set 1	Set of periodontal instruments, set 1	104
139 50 0780	Soubor parodontologických nástrojů, set 2	Set of periodontal instruments, set 2	104
139 50 0810	Soubor parodontologických nástrojů Mini, set 1	Set of mini periodontal instruments, set 1	104
147	Nástroje na zubní kámen	Scalers	
147 51 0010	Nástroj na zubní kámen; 15,5 cm	Scaler; 15,5 cm	106
147 51 0016	Nástroj na zubní kámen; 15,5 cm	Scaler; 15,5 cm	106
147 51 0018	Nástroj na zubní kámen; 15,5 cm TiN	Scaler TiN; 15,5 cm	106
147 51 0020	Drápek na zubní kámen; 15,5 cm	Scaler; 15,5 cm	106
147 51 0026	Drápek na zubní kámen; 15,5 cm	Scaler; 15,5 cm	106
147 51 0028	Drápek na zubní kámen; 15,5 cm TiN	Scaler TiN; 15,5 cm	106
147 51 0030	Srpek na zubní kámen; 0,6 mm; 15,5 cm	Scaler; 0,6 mm; 15,5 cm	106
147 51 0036	Srpek na zubní kámen; 0,6 mm; 15,5 cm	Scaler; 0,6 mm; 15,5 cm	106
147 51 0038	Srpek na zubní kámen; 0,6 mm; 15,5 cm TiN	Scaler TiN; 0,6 mm; 15,5 cm	106
147 51 0040	Srpek na zubní kámen; 0,9 mm; 15,5 cm	Scaler; 0,9 mm; 15,5 cm	76, 106
147 51 0046	Srpek na zubní kámen; 0,9 mm; 15,5 cm	Scaler; 0,9 mm; 15,5 cm	106
147 51 0048	Srpek na zubní kámen; 0,9 mm; 15,5 cm TiN	Scaler TiN; 0,9 mm; 15,5 cm	106
147 51 0060	Srpek na zubní kámen 2xzlomený; 15,5, cm	Scaler double angled; 15,5, cm	107
147 51 0066	Srpek na zubní kámen 2xzlomený; 15,5, cm	Scaler double angled; 15,5, cm	107
147 51 0068	Srpek na zubní kámen 2xzlomený; 15,5, cm TiN	Scaler double angled TiN; 15,5, cm	107
147 51 0070	Škrabka na zubní kámen pravá; 2 mm; 15,5 cm	Scaler right; 2 mm; 15,5 cm	107
147 51 0076	Škrabka na zubní kámen pravá; 2 mm; 15,5 cm	Scaler right; 2 mm; 15,5 cm	108
147 51 0078	Škrabka na zubní kámen pravá; 2 mm; 15,5 cm TiN	Scaler right TiN; 2 mm; 15,5 cm	107
147 51 0080	Škrabka na zubní kámen pravá; 3 mm; 15,5 cm	Scaler right; 3 mm; 15,5 cm	107
147 51 0086	Škrabka na zubní kámen pravá; 3 mm; 15,5 cm	Scaler right; 3 mm; 15,5 cm	108
147 51 0088	Škrabka na zubní kámen pravá; 3 mm; 15,5 cm TiN	Scaler right TiN; 3 mm; 15,5 cm	107
147 51 0100	Škrabka na zubní kámen levá; 2 mm; 15,5 cm	Scaler left; 2 mm; 15,5 cm	107
147 51 0106	Škrabka na zubní kámen levá; 2 mm; 15,5 cm	Scaler left; 2 mm; 15,5 cm	108
147 51 0108	Škrabka na zubní kámen levá; 2 mm; 15,5 cm TiN	Scaler left TiN; 2 mm; 15,5 cm	107
147 51 0110	Škrabka na zubní kámen levá; 3 mm; 15,5 cm	Scaler left; 3 mm; 15,5 cm	107
147 51 0116	Škrabka na zubní kámen levá; 3 mm; 15,5 cm	Scaler left; 3 mm; 15,5 cm	108
147 51 0118	Škrabka na zubní kámen levá; 3 mm; 15,5 cm TiN	Scaler left TiN; 3 mm; 15,5 cm	107
147 51 0130	Black dlátko na sklovinu pravé; 9×2 mm; 15,5 cm	Black scaler right; 9×2 mm; 15,5 cm	111
147 51 0136	Black dlátko na sklovinu pravé; 9×2 mm; 15,5 cm	Black scaler right; 9×2 mm; 15,5 cm	111
147 51 0138	Black dlátko na sklovinu pravé; 9×2 mm; 15,5 cm TiN	Black scaler right TiN; 9×2 mm; 15,5 cm	111
147 51 0150	Black dlátko na sklovinu levé; 9×2 mm; 15,5 cm	Black scaler left; 9×2 mm; 15,5 cm	111
147 51 0156	Black dlátko na sklovinu levé; 9×2 mm; 15,5 cm	Black scaler left; 9×2 mm; 15,5 cm	111
147 51 0158	Black dlátko na sklovinu levé; 9×2 mm; 15,5 cm TiN	Black scaler left TiN; 9×2 mm; 15,5 cm	111
147 51 0170	Black dlátko na sklovinu pravé; 8×1,5 mm; 15,5 cm	Black scaler right; 8×1,5 mm; 15,5 cm	111
147 51 0176	Black dlátko na sklovinu pravé; 8×1,5 mm; 15,5 cm	Black scaler right; 8×1,5 mm; 15,5 cm	111
147 51 0178	Black dlátko na sklovinu pravé; 8×1,5 mm; 15,5 cm TiN	Black scaler right TiN; 8×1,5 mm; 15,5 cm	111
147 51 0180	Black dlátko na sklovinu levé; 8×1,5 mm; 15,5 cm	Black scaler left; 8×1,5 mm; 15,5 cm	111
147 51 0186	Black dlátko na sklovinu levé; 8×1,5 mm; 15,5 cm	Black scaler left; 8×1,5 mm; 15,5 cm	111
147 51 0188	Black dlátko na sklovinu levé; 8×1,5 mm; 15,5 cm TiN	Black scaler left TiN; 8×1,5 mm; 15,5 cm	111
147 51 0200	Nástroj na zubní kámen pravý; 1,5 mm; 15,5 cm	Cutting instrument right; 1,5 mm; 15,5 cm	109
147 51 0206	Nástroj na zubní kámen pravý; 1,5 mm; 15,5 cm	Cutting instrument right; 1,5 mm; 15,5 cm	109
147 51 0208	Nástroj na zubní kámen pravý; 1,5 mm; 15,5 cm TiN	Cutting instrument right TiN; 1,5 mm; 15,5 cm	109
147 51 0210	Nástroj na zubní kámen pravý; 2,0 mm; 15,5 cm	Cutting instrument right; 2,0 mm; 15,5 cm	109
147 51 0216	Nástroj na zubní kámen pravý; 2,0 mm; 15,5 cm	Cutting instrument right; 2,0 mm; 15,5 cm	109
147 51 0218	Nástroj na zubní kámen pravý; 2,0 mm; 15,5 cm TiN	Cutting instrument right TiN; 2,0 mm; 15,5 cm	109

číslo – number	název	item	strana – page
147 51 0220	Nástroj na zubní kámen pravý; 2,5 mm; 15,5 cm	Cutting instrument right; 2,5 mm; 15,5 cm	109
147 51 0226	Nástroj na zubní kámen pravý; 2,5 mm; 15,5 cm	Cutting instrument right; 2,5 mm; 15,5 cm	109
147 51 0228	Nástroj na zubní kámen pravý; 2,5 mm; 15,5 cm TiN	Cutting instrument right TiN; 2,5 mm; 15,5 cm	109
147 51 0250	Nástroj na zubní kámen levý; 1,5 mm; 15,5 cm	Cutting instrument left; 1,5 mm; 15,5 cm	109
147 51 0256	Nástroj na zubní kámen levý; 1,5 mm; 15,5 cm	Cutting instrument left; 1,5 mm; 15,5 cm	109
147 51 0258	Nástroj na zubní kámen levý; 1,5 mm; 15,5 cm TiN	Cutting instrument left TiN; 1,5 mm; 15,5 cm	109
147 51 0260	Nástroj na zubní kámen levý; 2,0 mm; 15,5 cm	Cutting instrument left; 2,0 mm; 15,5 cm	109
147 51 0266	Nástroj na zubní kámen levý; 2,0 mm; 15,5 cm	Cutting instrument left; 2,0 mm; 15,5 cm	109
147 51 0268	Nástroj na zubní kámen levý; 2,0 mm; 15,5 cm TiN	Cutting instrument left TiN; 2,0 mm; 15,5 cm	109
147 51 0270	Nástroj na zubní kámen levý; 2,5 mm; 15,5 cm	Cutting instrument left; 2,5 mm; 15,5 cm	109
147 51 0276	Nástroj na zubní kámen levý; 2,5 mm; 15,5 cm	Cutting instrument left; 2,5 mm; 15,5 cm	109
147 51 0278	Nástroj na zubní kámen levý; 2,5 mm; 15,5 cm TiN	Cutting instrument left TiN; 2,5 mm; 15,5 cm	109
147 51 0300	Black dlátko na sklovinu; 9x1,5 mm; 15,5 cm	Black enamel chisel; 9x1,5 mm; 15,5 cm	110
147 51 0306	Black dlátko na sklovinu; 9x1,5 mm; 15,5 cm	Black enamel chisel; 9x1,5 mm; 15,5 cm	110
147 51 0308	Black dlátko na sklovinu; 9x1,5 mm; 15,5 cm TiN	Black enamel chisel TiN; 9x1,5 mm; 15,5 cm	110
147 51 0310	Black dlátko na sklovinu; 9x2,0 mm; 15,5 cm	Black enamel chisel; 9x2,0 mm; 15,5 cm	110
147 51 0316	Black dlátko na sklovinu; 9x2,0 mm; 15,5 cm	Black enamel chisel; 9x2,0 mm; 15,5 cm	110
147 51 0318	Black dlátko na sklovinu; 9x2,0 mm; 15,5 cm TiN	Black enamel chisel TiN; 9x2,0 mm; 15,5 cm	110
147 51 0320	Black dlátko na sklovinu; 9x3,0 mm; 15,5 cm	Black enamel chisel; 9x3,0 mm; 15,5 cm	110
147 51 0326	Black dlátko na sklovinu; 9x3,0 mm; 15,5 cm	Black enamel chisel; 9x3,0 mm; 15,5 cm	110
147 51 0328	Black dlátko na sklovinu; 9x3,0 mm; 15,5 cm TiN	Black enamel chisel TiN; 9x3,0 mm; 15,5 cm	110
147 51 0336	Black škrabka na zubní kámen levá; 1,0 mm; 15,5 cm	Black scaler left; 1,0 mm; 15,5 cm	108
147 51 0346	Black škrabka na zubní kámen pravá; 1,0 mm; 15,5 cm	Black scaler right; 1,0 mm; 15,5 cm	108
147 51 0350	Black dlátko na sklovinu zahnuté; 8x1,5 mm; 15,5 cm	Black enamel chisel curved; 8x1,5 mm; 15,5 cm	110
147 51 0356	Black dlátko na sklovinu zahnuté; 8x1,5 mm; 15,5 cm	Black enamel chisel curved; 8x1,5 mm; 15,5 cm	110
147 51 0358	Black dlátko na sklovinu zahnuté; 8x1,5 mm; 15,5 cm TiN	Black enamel chisel curved TiN; 8x1,5 mm; 15,5 cm	110
147 51 0360	Black dlátko na sklovinu zahnuté; 9x2 mm; 15,5 cm	Black enamel chisel curved; 9x2 mm; 15,5 cm	110
147 51 0366	Black dlátko na sklovinu zahnuté; 9x2 mm; 15,5 cm	Black enamel chisel curved; 9x2 mm; 15,5 cm	110
147 51 0368	Black dlátko na sklovinu zahnuté; 9x2 mm; 15,5 cm TiN	Black enamel chisel curved TiN; 9x2 mm; 15,5 cm	110
147 51 0376	Black dlátko na sklovinu levé; 8x1 mm; 15,5 cm	Black enamel chisel left; 8x1 mm; 15,5 cm	111
147 51 0386	Black dlátko na sklovinu pravé; 8x1 mm; 15,5 cm	Black enamel chisel right; 8x1 mm; 15,5 cm	111
147 51 0806	Zešikmovač gingiválních okrajů distální; 16,6 cm	Gingival margin trimmer distal; 16,6 cm	108
147 51 0816	Zešikmovač gingiválních okrajů mezíální; 16,6 cm	Gingival margin trimmer mesial; 16,6 cm	108
148	Exkavátory	Excavators	
148 51 0010	Exkavátor jednostranný rovný; 2,0 mm; 15,5 cm	Excavator straight; 2,0 mm; 15,5 cm	79
148 51 0016	Exkavátor jednostranný rovný; 2,0 mm; 15,5 cm	Excavator straight; 2,0 mm; 15,5 cm	79
148 51 0026	Exkavátor jednostranný rovný; 2,5 mm; 15,5 cm	Excavator straight; 2,5 mm; 15,5 cm	79
148 51 0056	Exkavátor jednostr.zahnutý pravý; 1,5 mm; 15,5 cm	Excavator curved right; 1,5 mm; 15,5 cm	79
148 51 0076	Exkavátor jednostr.zahnutý levý; 1,5 mm; 15,5 cm	Excavator curved left; 1,5 mm; 15,5 cm	79
148 51 0096	Exkavátor oboustranný; 0,8/1,0 mm; 16,8 cm	Excavator double-faced; 0,8/1,0 mm; 16,8 cm	80
148 51 0100	Exkavátor oboustranný; 1,5 mm; 17,0 cm	Excavator double-faced; 1,5 mm; 17,0 cm	80
148 51 0106	Exkavátor oboustranný; 1,5 mm; 16,8 cm	Excavator double-faced; 1,5 mm; 16,8 cm	80
148 51 0110	Exkavátor oboustranný; 2,0 mm; 17,0 cm	Excavator double-faced; 2,0 mm; 17,0 cm	76, 80
148 51 0116	Exkavátor oboustranný; 2,0 mm; 16,8 cm	Excavator double-faced; 2,0 mm; 16,8 cm	80
148 51 0120	Exkavátor oboustranný; 2,5 mm; 17,0 cm	Excavator double-faced; 2,5 mm; 17,0 cm	80
148 51 0126	Exkavátor oboustranný; 2,5 mm; 16,8 cm	Excavator double-faced; 2,5 mm; 16,8 cm	80
148 51 0136	Exkavátor oboustranný; 1,0 mm; 16,8 cm	Excavator double-faced; 1,0 mm; 16,8 cm	80
151	Nástroje pro výplně	Filling Instruments	
151 51 0010	Nosič amalgamu lopatkový; 3,0 mm; 15,5 cm	Plastic filling instrument – carrier; 3,0 mm; 15,5 cm	81
151 51 0016	Nosič amalgamu lopatkový; 3,0 mm; 15,5 cm	Plastic filling instrument – carrier; 3,0 mm; 15,5 cm	81
151 51 0056	Nosič amalgamu lžičkový; 1,2/3 mm; 16,7 cm	Plastic filling instrument – carrier; 1,2/3 mm; 16,7 cm	81
151 51 0060	Nosič amalgamu s kříž. řezem; 1,2/3 mm; 17,0 cm	Plastic filling instrument – carrier; 1,2/3 mm; 17,0 cm	81
151 51 0066	Nosič amalgamu s kříž. řezem; 1,2/3 mm; 16,7 cm	Plastic filling instrument – carrier; 1,2/3 mm; 16,7 cm	81
151 51 0080	Cpátko amalgamu oboustranné; 2/3 mm; 17,0 cm	Plastic filling instrument – plugger; 2/3 mm; 17,0 cm	82
151 51 0086	Cpátko amalgamu oboustranné; 2/3 mm; 16,5 cm	Plastic filling instrument – plugger; 2/3 mm; 16,5 cm	82
151 51 0096	Cpátko amalgamu oboustranné; 2/3 mm; 16,5 cm	Plastic filling instrument – plugger; 2/3 mm; 16,5 cm	82
151 51 0097	Cpátko kompoz.mater.oboustr.; 2/3 mm; 17,0 cm TiN	Plastic filling instrument – plugger TiN; 2/3 mm; 17,0 cm	82
151 51 0126	Hladítko se cpátkem fig. 1; 16,6 cm	Plastic filling instrument – spatula-plugger fig. 1; 16,6 cm	86
151 51 0127	Hladítko se cpátkem fig. 1; 16,6 cm TiN	Plastic filling instrument – spatula-plugger fig. 1 TiN; 16,6 cm	86
151 51 0130	Hladítko se cpátkem fig. 1; 17,0 cm	Plastic filling instrument – spatula-plugger fig. 1; 17,0 cm	86
151 51 0136	Hladítko se cpátkem fig. 1; 16,6 cm	Plastic filling instrument – spatula-plugger fig. 1; 16,6 cm	86
151 51 0140	Hladítko se cpátkem fig. 2; 17,0 cm	Plastic filling instrument – spatula-plugger fig. 2; 17,0 cm	86
151 51 0146	Hladítko se cpátkem fig. 2; 16,6 cm	Plastic filling instrument – spatula-plugger fig. 2; 16,6 cm	86
151 51 0160	Cpátko jednostr.kořenové lomené; 0,8 mm; 16,0 cm	Plastic filling instrument – plugger; 0,8 mm; 16,0 cm	84
151 51 0166	Cpátko jednostr.kořenové lomené; 0,8 mm; 15,8 cm	Plastic filling instrument – plugger; 0,8 mm; 15,8 cm	84
151 51 0170	Cpátko jednostr.kořenové lomené; 1,2 mm; 16,0 cm	Plastic filling instrument – plugger; 1,2 mm; 16,0 cm	84
151 51 0176	Cpátko jednostr.kořenové lomené; 1,2 mm; 15,8 cm	Plastic filling instrument – plugger; 1,2 mm; 15,8 cm	84
151 51 0177	Cpátko jednostr.kořenové lomené; 1,2 mm; 17,0 cm TiN	Plastic filling instrument – plugger TiN; 1,2 mm; 17,0 cm	84
151 51 0186	Cpátko oboustranné; 0,6/0,8 mm; 16,7 cm	Plastic filling instrument – plugger; 0,6/0,8 mm; 16,7 cm	84

číslo – number	název	item	strana – page
151 51 0187	Cpátka oboustranné; 0,6/0,8 mm; 17,0 cm TiN	Plastic filling instrument – plugger TiN; 0,6/0,8 mm; 17,0 cm	84
151 51 0190	Cpátka oboustranné; 1,2/1,6 mm; 17,0 cm	Plastic filling instrument – plugger; 1,2/1,6 mm; 17,0 cm	84
151 51 0196	Cpátka oboustranné; 1,2/1,6 mm; 16,8 cm	Plastic filling instrument – plugger; 1,2/1,6 mm; 16,8 cm	84
151 51 0197	Cpátka oboustranné; 1,2/1,6 mm; 17,0 cm TiN	Plastic filling instrument – plugger TiN; 1,2/1,6 mm; 17,0 cm	84
151 51 0200	Cpátka oboustranné; 2,0/2,5 mm; 17,0 cm	Plastic filling instrument – plugger; 2,0/2,5 mm; 17,0 cm	84
151 51 0206	Cpátka oboustranné; 2,0/2,5 mm; 16,8 cm	Plastic filling instrument – plugger; 2,0/2,5 mm; 16,8 cm	84
151 51 0207	Cpátka oboustranné; 2,0/2,5 mm; 17,0 cm TiN	Plastic filling instrument – plugger TiN; 2,0/2,5 mm; 17,0 cm	84
151 51 0246	Hladítko se cpátkem fig. 2; 16,6 cm	Plastic filling instrument – spatula-plugger fig. 2; 16,6 cm	86
151 51 0247	Hladítko se cpátkem fig. 2; 16,6 cm TiN	Plastic filling instrument – spatula-plugger TiN; 16,6 cm	86
151 51 0280	Cpátka oboustranné; 1,0/1,8 mm; 17,0 cm	Plastic filling instrument – plugger; 1,0/1,8 mm; 17,0 cm	83
151 51 0286	Cpátka oboustranné; 1,0/1,8 mm; 16,6 cm	Plastic filling instrument – plugger; 1,0/1,8 mm; 16,6 cm	83
151 51 0287	Cpátka oboustranné; 1,0/1,8 mm; 17,0 cm TiN	Plastic filling instrument – plugger TiN; 1,0/1,8 mm; 17,0 cm	83
151 51 0290	Cpátka oboustranné; 1,4/2,0 mm; 17,0 cm	Plastic filling instrument – plugger; 1,4/2,0 mm; 17,0 cm	83
151 51 0296	Cpátka oboustranné; 1,4/2,0 mm; 16,6 cm	Plastic filling instrument – plugger; 1,4/2,0 mm; 16,6 cm	83
151 51 0297	Cpátka oboustranné; 1,4/2,0 mm; 17,0 cm TiN	Plastic filling instrument – plugger TiN; 1,4/2,0 mm; 17,0 cm	83
151 51 0306	Cpátka oboustranné; 0,6/0,8 mm; 16,6 cm	Plastic filling instrument – plugger; 0,6/0,8 mm; 16,6 cm	83
151 51 0310	Cpátka kopýtkové oboustranné; 17,0 cm	Plastic filling instrument – plugger; 17,0 cm	83
151 51 0316	Cpátka kopýtkové oboustranné; 16,6 cm	Plastic filling instrument – plugger; 16,6 cm	83
151 51 0317	Cpátka kopýtkové oboustranné; 17,0 cm TiN	Plastic filling instrument – plugger TiN; 17,0 cm	83
151 51 0320	Cpátka oboustranné; 17,0 cm	Plastic filling instrument – plugger; 17,0 cm	82
151 51 0326	Cpátka oboustranné; 16,6 cm	Plastic filling instrument – plugger; 16,6 cm	82
151 51 0340	Hladítko se cpátkem fig. 3; 17,0 cm	Plastic filling instrument – spatula-plugger fig. 3; 17,0 cm	86
151 51 0346	Hladítko se cpátkem fig. 3; 16,6 cm	Plastic filling instrument – spatula-plugger fig. 3; 16,6 cm	86
151 51 0347	Hladítko se cpátkem fig. 3; 16,6 cm TiN	Plastic filling instrument – spatula-plugger fig. 3 TiN; 16,6 cm	86
151 51 0356	Hladítko se cpátkem; 1,0/1,5 mm; 16,4 cm	Plastic filling instrument – spatula-plugger; 1,0/1,5 mm; 16,4 cm	86
151 51 0416	Nosič amalgamu; 1,4/2,0 mm; 16,6 cm	Plastic filling instrument – carrier; 1,4/2,0 mm; 16,6 cm	81
151 51 0426	Nosič amalgamu; 2,5/3,0 mm; 17,0 cm	Plastic filling instrument – carrier; 2,5/3,0 mm; 17,0 cm	81
151 51 0466	Cpátka vlákna do sulku; 2 mm; 16,6 cm	Fibre filling instrument; 2 mm; 16,6 cm	85
151 51 0506	Cpátka vlákna do sulku; 15,4 cm	Fibre filling instrument; 15,4 cm	85
151 51 0516	Zavaděč retrakčních vláken; 16,8 cm	Retentive fibre instrument; 16,8 cm	85
151 51 0526	Zavaděč retrakčních vláken; 16,8 cm	Retentive fibre instrument; 16,8 cm	85
151 51 0570	Hladítko pružné; 2,5 mm; 15,5 cm	Plastic filling instrument; 2,5 mm; 15,5 cm	88
151 51 0576	Hladítko pružné; 2,5 mm; 15,3 cm	Plastic filling instrument; 2,5 mm; 15,3 cm	88
151 51 0577	Hladítko pružné; 2,5 mm; 15,5 cm TiN	Plastic filling instrument TiN; 2,5 mm; 15,5 cm	88
151 51 0590	Nástroj na plast.výplně kapkovitý fig. 1; 15,5 cm	Plastic filling instrument fig. 1; 15,5 cm	92
151 51 0596	Nástroj na plast.výplně kapkovitý fig. 1; 15,3 cm	Plastic filling instrument fig. 1; 15,3 cm	92
151 51 0597	Nástroj na plast.výplně kapk. fig. 1; 15,5 cm TiN	Plastic filling instrument fig. 1 TiN; 15,5 cm	92
151 51 0600	Nástroj na plast.výplně kapkovitý fig. 2; 15,5 cm	Plastic filling instrument – spatula fig. 2; 15,5 cm	92
151 51 0606	Nástroj na plast.výplně kapkovitý fig. 2; 15,3 cm	Plastic filling instrument – spatula fig. 2; 15,3 cm	92
151 51 0607	Nástroj na plast.výplně kapk. fig. 2; 15,5 cm TiN	Plastic filling instrument – spatula fig. 2 TiN; 15,5 cm	92
151 51 0616	Nástroj na plast. výplně; 16,6 cm	Plastic filling instrument; 16,6 cm	92
151 51 0620	Hladítko oboustranné fig. 1; 17,0 cm	Plastic filling instrument – spatula fig. 1; 17,0 cm	89
151 51 0626	Hladítko oboustranné fig. 1; 16,6 cm	Plastic filling instrument – spatula fig. 1; 16,6 cm	89
151 51 0627	Hladítko oboustranné fig. 1; 16,6 cm TiN	Plastic filling instrument – spatula fig. 1 TiN; 16,6 cm	89
151 51 0630	Hladítko oboustranné fig. 2; 17,0 cm	Plastic filling instrument – spatula fig. 2; 17,0 cm	89
151 51 0636	Hladítko oboustranné fig. 2; 16,6 cm	Plastic filling instrument – spatula fig. 2; 16,6 cm	89
151 51 0637	Hladítko oboustranné fig. 2; 16,6 cm TiN	Plastic filling instrument – spatula fig. 2 TiN; 16,6 cm	89
151 51 0650	Hladítko oboustranné 3x lomené; 17,0 cm	Plastic filling instrument – spatula; 17,0 cm	88
151 51 0656	Hladítko oboustranné 3x lomené; 16,6 cm	Plastic filling instrument – spatula; 16,6 cm	88
151 51 0657	Hladítko oboustranné 3x lomené; 17,0 cm TiN	Plastic filling instrument – spatula TiN; 17,0 cm	88
151 51 0690	Hladítko oboustranné; 1,5 mm; 17,0 cm	Spatula – filling instrument; 1,5 mm; 17,0 cm	89
151 51 0696	Hladítko oboustranné; 1,5 mm; 16,6 cm	Spatula – filling instrument; 1,5 mm; 16,6 cm	89
151 51 0706	Heidemann hladítko oboustranné fig. 1; 16,6 cm	Heidemann spatula fig. 1; 16,6 cm	89
151 51 0716	Heidemann hladítko oboustranné fig. 2; 16,9 cm	Heidemann spatula fig. 2; 16,9 cm	89
151 51 0726	Heidemann hladítko oboustranné fig. 2; 17,3 cm	Heidemann spatula fig. 2; 17,3 cm	89
151 51 0760	Pistole na amalgam s kovovým pístem	Amalgam gun – metal piston	94
151 51 0770	Pistole na amalgam s kovovým pístem	Amalgam gun – metal piston	94
151 51 0780	Pistole na amalgam plastová	Amalgam gun plastic	94
151 51 0806	Nástroj na modelování výplně; 1,6 mm; 16,4 cm	Modelling instrument; 1,6 mm; 16,4 cm	90
151 51 0836	Nástroj na modelování výplně; 2,5 mm; 16,4 cm	Modelling instrument; 2,5 mm; 16,4 cm	90
151 51 0846	Nástroj na modelování výplně; 2,5 mm; 16,4 cm	Modelling instrument; 2,5 mm; 16,4 cm	90
151 51 0856	Sapin nástroj na modelování výplně; 1,6 mm; 16,0 cm	Sapin modelling instrument; 1,6 mm; 16,0 cm	90
151 51 0866	Frahm nástroj na modelování výplně; 5,0 mm; 16,6 cm	Frahm modelling instrument; 5,0 mm; 16,6 cm	90
151 51 0876	Nástroj na modelování výplně; 1,4 mm; 16,6 cm	Modelling instrument; 1,4 mm; 16,6 cm	90
151 51 0886	Nástroj na modelování výplně; 1,6/2,5 mm; 16,4 cm	Modelling instrument; 1,6/2,5 mm; 16,4 cm	91
151 51 0887	Nástroj na modelov.výplně; 1,6/2,5 mm; 17,0 cm TiN	Modelling instrument TiN; 1,6/2,5 mm; 17,0 cm	91
151 51 0896	Nástroj na modelování výplně; 2,2 mm; 16,8 cm	Modelling instrument; 2,2 mm; 16,8 cm	92
151 51 0916	Nástroj na výplně ostrý; 16,6 cm	Modelling instrument; 16,6 cm	90
151 51 0930	Discoïd-Cleoid nástroj na výplně; 2,0/2,2 mm; 16,8 cm	Discoïd-Cleoid filling instrument; 2,0/2,2 mm; 16,8 cm	92

číslo – number	název	item	strana – page
151 51 0936	Discoïd-Cleoid nástroj na výplně; 2,0/2,2 mm; 16,8 cm	Discoïd-Cleoid filling instrument; 2,0/2,2 mm; 16,8 cm	92
151 51 0940	Nástroj na výplně; 2,5/3,0 mm; 16,6 cm	Plastic filling instrument – plugger; 2,5/3,0 mm; 16,6 cm	91
151 51 0946	Nástroj na výplně; 2,5/3,0 mm; 16,6 cm	Plastic filling instrument – plugger; 2,5/3,0 mm; 16,6 cm	91
151 51 0970	Svorka na separační pásky 40° zahnutá; 3,3 cm	Strip clamp; 3,3 cm	93
151 51 0980	Svorka na separační pásky 90° zahnutá; 2,5 cm	Strip clamp; 2,5 cm	93
151 51 1010	Pásek separační hladký; 120×6 mm	Separative strip smooth; 120×6 mm	93
151 51 1020	Pásek separační hladký; 120×8 mm	Separative strip smooth; 120×8 mm	93
151 51 1496	Wiland nástroj na výplně oboustranný; 16,6 cm	Wiland amalgam carver double-faced; 16,6 cm	90
151 51 2020	Pásek separační diamant. 120×3 mm; D40	Separative strip diamond 120×3 mm; D40	93
151 51 2021	Pásek separační diamant. 120×3 mm; D64	Separative strip diamond 120×3 mm; D64	93
151 51 2022	Pásek separační diamant. 120×3 mm; D107	Separative strip diamond 120×3 mm; D107	93
151 51 2030	Pásek separační diamant. 120×4 mm; D40	Separative strip diamond 120×4 mm; D40	93
151 51 2031	Pásek separační diamant. 120×4 mm; D64	Separative strip diamond 120×4 mm; D64	93
151 51 2032	Pásek separační diamant. 120×4 mm; D107	Separative strip diamond 120×4 mm; D107	93
151 51 2040	Pásek separační diamant. 120×6 mm; D40	Separative strip diamond 120×6 mm; D40	93
151 51 2041	Pásek separační diamant. 120×6 mm; D64	Separative strip diamond 120×6 mm; D64	93
151 51 2042	Pásek separační diamant. 120×6 mm; D107	Separative strip diamond 120×6 mm; D107	93
151 51 2051	Pásek separační diamant. 120×8 mm; D64	Separative strip diamond 120×8 mm; D64	93
151 51 2052	Pásek separační diamant. 120×8 mm; D107	Separative strip diamond 120×8 mm; D107	93
151 51 3006	Cpátko oboustran.kombinované; 0,8/1,0 mm; 16,6 cm	Plastic filling instrument – plugger; 0,8/1,0 mm; 16,6 cm	83
151 51 3016	Cpátko oboustran.kombinované; 1,2/1,4 mm; 16,6 cm	Plastic filling instrument – plugger; 1,2/1,4 mm; 16,6 cm	83
151 51 3026	Cpátko oboustran.kombinované; 1,6/2,0 mm; 16,6 cm	Plastic filling instrument – plugger; 1,6/2,0 mm; 16,6 cm	83
151 51 3056	Cpátko kuličkové s hladítkem; 1,2/1,5 mm; 16,6 cm	Plastic filling instrument – spatula-plugger; 1,2/1,5 mm; 16,6 cm	87
151 51 3076	Cpátko kuličkové s hladítkem; 2,0/2,5 mm; 16,8 cm	Plastic filling instrument – spatula-plugger; 2,0/2,5 mm; 16,8 cm	87
151 51 3086	Cpátko kuličkové s hladítkem; 2,5/3,0 mm; 17,0 cm	Plastic filling instrument – spatula-plugger; 2,5/3,0 mm; 17,0 cm	87
151 51 3146	Cpátko oboustranné oválné; 2,0×1,0 mm; 16,4 cm	Plastic filling instrument – plugger; 2,0×1,0 mm; 16,4 cm	82
151 51 3186	Planátor; 1,4/1,7 mm; 16,1 cm	Amalgam condenser; 1,4/1,7 mm; 16,1 cm	91
151 51 3196	Planátor; 1,9/2,3 mm; 16,6 cm	Amalgam condenser; 1,9/2,3 mm; 16,6 cm	91
151 51 3210	Nástroj pro výplně; 1,4 mm; 16,6 cm	Filling instrument; 1,4 mm; 16,6 cm	90
151 51 3220	Nástroj pro výplně; 2,0 mm; 16,6 cm	Filling instrument; 2,0 mm; 16,6 cm	90
151 51 3256	Cpátko kuličkové s hladítkem; 1,2/1,5 mm; 16,4 cm	Plastic filling instrument – spatula-plugger; 1,2/1,5 mm; 16,4 cm	87
151 51 3570	Hladítko pružné jemné; 15,5 cm	Plastic filling instrument – spatula flexible; 15,5 cm	88
151 51 3576	Hladítko pružné jemné; 15,3 cm	Plastic filling instrument – spatula flexible; 15,3 cm	88
151 51 3577	Hladítko pružné jemné; 15,5 cm TiN	Plastic filling instrument TiN – spatula flexible; 15,5 cm	88
151 51 3620	Hladítko oboustranné jemné fig. 1; 17,0 cm	Plastic filling instrument – spatula fig. 1; 17,0 cm	89
151 51 3626	Hladítko oboustranné jemné fig. 1; 16,6 cm	Plastic filling instrument – spatula fig. 1; 16,6 cm	89
151 51 3627	Hladítko oboustranné jemné fig. 1; 16,6 cm TiN	Plastic filling instrument TiN – spatula fig. 1; 16,6 cm	89
151 51 3630	Hladítko oboustranné jemné fig. 2; 17,0 cm	Plastic filling instrument – spatula fig. 2; 17,0 cm	89
151 51 3636	Hladítko oboustranné jemné fig. 2; 16,6 cm	Plastic filling instrument – spatula fig. 2; 16,6 cm	89
151 51 3637	Hladítko oboustranné jemné fig. 2; 16,6 cm TiN	Plastic filling instrument TiN – spatula fig. 2; 16,6 cm	89
151 51 3650	Hladítko oboustranné jemné 3× lomené; 17,0 cm	Plastic filling instrument – spatula; 17,0 cm	88
151 51 3656	Hladítko oboustranné jemné 3× lomené; 16,6 cm	Plastic filling instrument – spatula; 16,6 cm	88
151 51 3657	Hladítko oboustranné jemné 3× lomené; 16,6 cm TiN	Plastic filling instrument TiN – spatula; 16,6 cm	88
151 56 0056	Nosič amalgamu lžičkový; 1,2/3 mm; 16,7 cm	Carrier hollow handle; 1,2/3 mm; 16,7 cm	81
151 56 0066	Nosič amalgamu s kříž. řezem; 1,2/3 mm; 16,7 cm	Carrier hollow handle; 1,2/3 mm; 16,7 cm	81
151 56 0086	Cpátko amalgamu oboustranné; 2/3 mm; 16,5 cm	Filling instrument – angled hollow handle; 2/3 mm; 16,5 cm	82
151 56 0096	Cpátko amalgamu oboustranné; 2/3 mm; 16,5 cm	Filling instrument – angled hollow handle; 2/3 mm; 16,5 cm	82
151 56 0097	Cpátko komp.mat.oboustr.; 2-3 mm; 16,6 cm TiN	Filling instrument – angled hollow handle TiN; 2/3 mm; 16,6 cm	82
151 56 0126	Hladítko se cpátkem fig. 1; 16,6 cm	Spatula – filling instrument hollow handle; 16,6 cm	86
151 56 0127	Hladítko se cpátkem fig. 1; 16,6 cm TiN	Spatula – filling instrument – hollow handle TiN; 16,6 cm	86
151 56 0136	Hladítko se cpátkem fig. 1; 16,6 cm	Spatula – filling instrument hollow handle; 16,6 cm	86
151 56 0146	Hladítko se cpátkem fig. 2; 17,0 cm	Spatula – filling instrument hollow handle; 17,0 cm	86
151 56 0186	Cpátko oboustranné; 0,6/0,8 mm; 16,7 cm	Filling instrument – angled hollow handle; 0,6/0,8 mm; 16,7 cm	84
151 56 0187	Cpátko oboustranné; 0,6/0,8 mm; 16,7 cm TiN	Filling instrument – angled hollow handle TiN; 0,6/0,8 mm; 16,7 cm	84
151 56 0196	Cpátko oboustranné; 1,2/1,6 mm; 16,8 cm	Filling instrument – angled hollow handle; 1,2/1,6 mm; 16,8 cm	84
151 56 0197	Cpátko oboustranné; 1,2/1,6 mm; 16,8 cm TiN	Filling instrument – angled hollow handle TiN; 1,2/1,6 mm; 16,8 cm	84
151 56 0206	Cpátko oboustranné; 2,0/2,5 mm; 16,8 cm	Filling instrument – angled hollow handle; 2,0/2,5 mm; 16,8 cm	84
151 56 0207	Cpátko oboustranné; 2,0/2,5 mm; 16,8 cm TiN	Filling instrument – angled hollow handle TiN; 2,0/2,5 mm; 16,8 cm	84
151 56 0246	Hladítko se cpátkem fig. 2; 16,6 cm	Spatula – filling instrument hollow handle; 16,6 cm	86
151 56 0247	Hladítko se cpátkem fig. 2; 16,6 cm TiN	Spatula – filling instrument hollow handle TiN; 16,6 cm	86
151 56 0286	Cpátko oboustranné; 1,0/1,8 mm; 16,6 cm	Filling instrument – angled hollow handle; 1,0/1,8 mm; 16,6 cm	83
151 56 0296	Cpátko oboustranné; 1,4/2,0 mm; 16,6 cm	Filling instrument – angled hollow handle; 1,4/2,0 mm; 16,6 cm	83
151 56 0306	Cpátko oboustranné; 0,6/0,8 mm; 16,6 cm	Filling instrument – angled hollow handle; 0,6/0,8 mm; 16,6 cm	83
151 56 0316	Cpátko kopýtkové oboustranné; 16,6 cm	Filling instrument – angled hollow handle; 16,6 cm	83
151 56 0317	Cpátko kopýtkové oboustranné; 16,6 cm TiN	Filling instrument – angled hollow handle TiN; 16,6 cm	83
151 56 0326	Cpátko oboustranné; 16,6 cm	Filling instrument – angled hollow handle; 16,6 cm	82
151 56 0346	Hladítko se cpátkem fig. 3; 16,6 cm	Spatula – filling instrument hollow handle; 16,6 cm	86
151 56 0347	Hladítko se cpátkem fig. 3; 16,6 cm TiN	Spatula – filling instrument hollow handle TiN; 16,6 cm	86
151 56 0356	Hladítko se cpátkem; 1,0/1,5 mm; 16,4 cm	Spatula – filling instrument hollow handle; 1,0/1,5 mm; 16,4 cm	86

číslo – number	název	item	strana – page
151 56 0416	Nosič amalgamu; 1,4/2,0 mm; 16,6 cm	Carrier hollow handle; 1,4/2,0 mm; 16,6 cm	81
151 56 0426	Nosič amalgamu; 2,5/3,0 mm; 16,6 cm	Carrier hollow handle; 2,5/3,0 mm; 16,6 cm	81
151 56 0466	Cpátka vlákna do sulku; 2 mm; 16,6 cm	Fibre filling instrument hollow handle; 2 mm; 16,6 cm	85
151 56 0516	Zavaděč retrakčních vláken (přední zuby), 2,5 mm; 16,8 cm	Retentive fibre instrument; 16,8 cm	85
151 56 0526	Zavaděč retrakčních vláken (zadní zuby), 2,5 mm; 16,8 cm	Retentive fibre instrument; 16,8 cm	85
151 56 0616	Nástroj na plast. výplně; 16,6 cm	Plastic filling instrument; 16,6 cm	92
151 56 0626	Hladítko oboustranné fig. 1; 16,6 cm	Spatula hollow handle; 16,6 cm	89
151 56 0627	Hladítko oboustranné fig. 1; 16,6 cm TiN	Spatula hollow handle tin; 16,6 cm TiN	89
151 56 0636	Hladítko oboustranné fig. 2; 16,6 cm	Spatula hollow handle; 16,6 cm	89
151 56 0637	Hladítko oboustranné fig. 2; 16,6 cm TiN	Spatula hollow handle TiN; 16,6 cm TiN	89
151 56 0656	Hladítko oboustranné 3x lomené; 16,6 cm	Spatula 3x angled hollow handle; 16,6 cm	88
151 56 0696	Hladítko oboustranné; 1,5 mm; 16,6 cm	Spatula – filling instrument hollow handle; 1,5 mm; 16,6 cm	89
151 56 0706	Heidemann hladítko oboustranné fig. 1; 16,6 cm	Heidemann spatula hollow handle; 16,6 cm	89
151 56 0716	Heidemann hladítko oboustranné fig. 2; 16,9 cm	Heidemann spatula hollow handle; 16,9 cm	89
151 56 0726	Heidemann hladítko oboustranné fig. 2; 17,3 cm	Heidemann spatula hollow handle; 17,3 cm	89
151 56 0806	Nástroj na modelování výplně; 1,6 mm; 16,4 cm	Filling instrument hollow handle; 1,6 mm; 16,4 cm	90
151 56 0836	Nástroj na modelování výplně; 2,5 mm; 16,4 cm	Filling instrument hollow handle; 2,5 mm; 16,4 cm	90
151 56 0846	Nástroj na modelování výplně; 2,5 mm; 16,4 cm	Filling instrument hollow handle; 2,5 mm; 16,4 cm	90
151 56 0856	Sapin nástroj na modelování výplně; 1,6 mm; 16,0 cm	Sapin filling instrument hollow handle; 1,6 mm; 16,0 cm	90
151 56 0866	Frahm nástroj na modelování výplně; 5,0 mm; 16,6 cm	Frahm filling instrument hollow handle; 5,0 mm; 16,6 cm	90
151 56 0876	Nástroj na modelování výplně; 1,4 mm; 16,6 cm	Filling instrument hollow handle; 1,4 mm; 16,6 cm	90
151 56 0886	Nástroj na modelování výplně; 1,6/2,5 mm; 16,4 cm	Filling instrument hollow handle; 1,6/2,5 mm; 16,4 cm	91
151 56 0896	Nástroj na modelování výplně; 2,2 mm; 16,8 cm	Modelling instrument hollow handle; 2,2 mm; 16,8 cm	92
151 56 0916	Nástroj na výplně ostrý; 16,6 cm	Modelling instrument hollow handle; 16,6 cm	90
151 56 0936	Discoid-Cleoid nástroj na výplně; 2,0/2,2 mm; 16,8 cm	Discoid-Cleoid filling instrument hollow handle TiN; 2,0/2,2 mm; 16,8 cm	92
151 56 0946	Nástroj na výplně; 2,5/3,0 mm; 16,6 cm	Plastic filling instrument – plugger hollow handle; 2,5/3,0 mm; 16,6 cm	91
151 56 1496	Wiland nástroj na výplně oboustranný; 16,6 cm	Wiland amalgam carver double-faced; 16,6 cm	90
151 56 3006	Cpátka oboustran.kombinované; 0,8/1,0 mm; 16,6 cm	Filling instrument – angled hollow handle; 0,8/1,0 mm; 16,6 cm	83
151 56 3016	Cpátka oboustran.kombinované; 1,2/1,4 mm; 16,6 cm	Filling instrument – angled hollow handle; 1,2/1,4 mm; 16,6 cm	83
151 56 3026	Cpátka oboustran.kombinované; 1,6/2,0 mm; 16,6 cm	Filling instrument – angled hollow handle; 1,6/2,0 mm; 16,6 cm	83
151 56 3186	Planátor; 1,4/1,7 mm; 16,1 cm	Amalgam condenser hollow handle; 1,4/1,7 mm; 16,1 cm	91
151 56 3196	Planátor; 1,9/2,3 mm; 16,6 cm	Amalgam condenser hollow handle; 1,9/2,3 mm; 16,6 cm	91
151 56 3626	Hladítko oboustranné jemné fig. 1; 16,6 cm	Spatula hollow handle; 16,6 cm	89
151 56 3627	Hladítko oboustranné jemné fig. 1; 16,6 cm TiN	Spatula hollow handle TiN; 16,6 cm TiN	89
151 56 3636	Hladítko oboustranné jemné fig. 2; 16,6 cm	Spatula hollow handle; 16,6 cm	89
151 56 3637	Hladítko oboustranné jemné fig. 2; 16,6 cm TiN	Spatula hollow handle TiN; 16,6 cm TiN	89
151 56 3656	Hladítko oboustranné jemné 3x lomené; 16,6 cm	Spatula 3x angled hollow handle; 16,6 cm	88
152	Ortodoncie, Zubní náhrady	Orthodontic, Tooth Replacement	
152 52 1900	Zesilovací mřížka zlacená; 60x54x12 mm	Mesh strengthener; 60x54x12 mm	128
152 52 1910	Zesilovací mřížka nerezová; 60x54x12 mm	Mesh strengthener; 60x54x12 mm	128
154	Otiskovací lžice	Impression Trays	
154 52 0110	Lžice otiskovací; BOX1	Impression tray; BOX1	129
154 52 0120	Lžice otiskovací; BOX2	Impression tray; BOX2	129
154 52 0130	Lžice otiskovací; BOX3	Impression tray; BOX3	129
154 52 0140	Lžice otiskovací; BOX4	Impression tray; BOX4	129
154 52 0260	Lžice otiskovací; FX1	Impression tray; FX1	129
154 52 0270	Lžice otiskovací; FX2	Impression tray; FX2	129
154 52 0280	Lžice otiskovací; FX3	Impression tray; FX3	129
154 52 0290	Lžice otiskovací; FX4	Impression tray; FX4	129
154 52 0360	Lžice otiskovací; DHX1	Impression tray; DHX1	130
154 52 0370	Lžice otiskovací; DHX2	Impression tray; DHX2	130
154 52 0380	Lžice otiskovací; DHX3	Impression tray; DHX3	130
154 52 0460	Lžice otiskovací; DDX1	Impression tray; DDX1	130
154 52 0470	Lžice otiskovací; DDX2	Impression tray; DDX2	130
154 52 0480	Lžice otiskovací; DDX3	Impression tray; DDX3	130
154 52 0550	Lžice otiskovací; PPX	Impression tray; PPX	129
154 52 0560	Lžice otiskovací; PLX	Impression tray; PLX	129
154 52 0600	Lžice otiskovací korunková	Crown impression tray	129
154 52 0610	Lžice otiskovací; FOX1	Impression tray; FOX1	130
154 52 0620	Lžice otiskovací; FOX2	Impression tray; FOX2	130
154 52 0630	Lžice otiskovací; FOX3	Impression tray; FOX3	130
154 52 0640	Lžice otiskovací; FOX4	Impression tray; FOX4	130
154 52 0660	Lžice otiskovací; UUX1	Impression tray; UUX1	130
154 52 0670	Lžice otiskovací; UUX2	Impression tray; UUX2	130
154 52 0680	Lžice otiskovací; UUX3	Impression tray; UUX3	130
154 52 0690	Lžice otiskovací; UUX4	Impression tray; UUX4	130
154 52 0790	Lžice otiskovací; BOXC3	Impression tray; BOXC3	130
154 52 0820	Lžice otiskovací; FXC2	Impression tray; FXC2	130
154 52 0830	Lžice otiskovací; FXC3	Impression tray; FXC3	130

číslo – number	název	item	strana – page
154 52 1550	Soubor otiskovacích lžic perforovaných; 9 ks	Set of impression perforated trays; 9 pcs	129
154 52 1650	Soubor otiskovacích lžic dětských perforovaných; 6 ks	Set of impression perforated trays for children	130
154 52 9010	Lžice otiskovací-nerez; H1	Impression tray-stainless steel; H1	129
154 52 9011	Lžice otiskovací-nerez; H2	Impression tray-stainless steel; H2	129
154 52 9012	Lžice otiskovací-nerez; H3	Impression tray-stainless steel; H3	129
154 52 9013	Lžice otiskovací-nerez; H4	Impression tray-stainless steel; H4	129
154 52 9014	Lžice otiskovací-nerez; D1	Impression tray-stainless steel; D1	129
154 52 9015	Lžice otiskovací-nerez; D2	Impression tray-stainless steel; D2	129
154 52 9016	Lžice otiskovací-nerez; D3	Impression tray-stainless steel; D3	129
154 52 9017	Lžice otiskovací-nerez; D4	Impression tray-stainless steel; D4	129
154 52 9018	Lžice otiskovací-nerez; HX1	Impression tray-stainless steel; HX1	129
154 52 9019	Lžice otiskovací-nerez; HX2	Impression tray-stainless steel; HX2	129
154 52 9020	Lžice otiskovací-nerez; HX3	Impression tray-stainless steel; HX3	129
154 52 9021	Lžice otiskovací-nerez; HX4	Impression tray-stainless steel; HX4	129
154 52 9022	Lžice otiskovací-nerez; DX1	Impression tray-stainless steel; DX1	129
154 52 9023	Lžice otiskovací-nerez; DX2	Impression tray-stainless steel; DX2	129
154 52 9024	Lžice otiskovací-nerez; DX3	Impression tray-stainless steel; DX3	129
154 52 9025	Lžice otiskovací-nerez; DX4	Impression tray-stainless steel; DX4	129
155	Nástroje modelovací	Modelling Instruments	
155 52 0180	Le Cron nástroj modelovací; 17,5 cm	Le Cron modelling instrument; 17,5 cm	122, 123
155 52 0212	Nůž modelovací; 13,0 cm	Modelling knife; 13,0 cm	122, 123
155 52 0222	Nůž modelovací; 17,4 cm	Modelling knife; 17,4 cm	122, 123
155 52 1442	Nástroj modelovací fig. 5; 16,2 cm	Modelling instrument fig. 5; 16,2 cm	124, 125
155 52 1462	Nástroj modelovací fig. 7; 15,6 cm	Modelling instrument fig. 7; 15,6 cm	124, 125
155 52 1472	Nástroj modelovací fig. 8; 15,9 cm	Modelling instrument fig. 8; 15,9 cm	124, 125
156	Matrice	Matrix Bands	
156 52 0010	Ivory matrice na tvarování výplní malá; 2,5 cm	Ivory matrix band small; 2,5 cm	96
156 52 0020	Ivory matrice na tvarování výplní střední; 3,6 cm	Ivory matrix band medium; 3,6 cm	96
156 52 0030	Ivory matrice na tvarování výplní velká; 3,5 cm	Ivory matrix band large; 3,5 cm	96
156 52 0050	Ivory napínač matric; 7,0 cm	Ivory matrix retainer; 7,0 cm	96
156 52 0070	Ivory separátor; 6,7 cm	Ivory separator; 6,7 cm	96
156 52 0300	Napínač matric; 6,4 cm	Universal retainer; 6,4 cm	97
156 91 0001	Matrice pásková; 5 mm; 1 m	Matrix band; 5 mm; 1 m	97
156 91 0002	Matrice pásková; 6 mm; 1 m	Matrix band; 6 mm; 1 m	97
156 91 0003	Matrice pásková; 7 mm; 1 m	Matrix band; 7 mm; 1 m	97
157	Kyvety, třmeny, lisy	Flasks, Claps, Presses	
157 52 0030	Třmen pro jednu kyvetu; 17,0 cm	Clap for one flask; 17,0 cm	126
157 52 0040	Třmen pro dvě kyvety; 22,5 cm	Clap for two flasks; 22,5 cm	126
157 52 0050	Třmen pro tři kyvety; 28,0 cm	Clap for three flasks; 28,0 cm	126
158	Pomůcky pro lití	Casting Devices	
158 52 0020	Kroužek kovový licí; 28×40 mm	Casting ring; 28×40 mm	128
158 52 0060	Kroužek kovový licí; 60×55 mm	Casting ring; 60×55 mm	128
158 52 0070	Kroužek kovový licí; 70×55 mm	Casting ring; 70×55 mm	128
158 52 0080	Kroužek kovový licí; 80×55 mm	Casting ring; 80×55 mm	128
158 91 0001	Podložka pod licí kroužky; 9,0 cm	Washer for casting rings; 9,0 cm	127
158 99 0022	Kroužek kovový licí; 38×55 mm	Casting ring; 38×55 mm	127
158 99 0024	Kroužek kovový licí; 65×55 mm	Casting ring; 65×55 mm	127
158 99 0025	Kroužek kovový licí; 30×55 mm	Casting ring; 30×55 mm	127
159	Pomocné vybavení	Auxiliary Devices	
159 53 0050	Nádobka na vatou s pružinou	Cotton wool box with spring	133
159 53 0060	Nádobka na vatové odpadky	Cotton wool container	133
159 53 0100	Držátko ubrousku řetízkové, UH svorky; 50 cm	Napkin holder with metal chain; 50 cm	133
159 53 0110	Držátko ubrousku UH, kovové svorky; 50 cm	Napkin holder; 50 cm	133
159 53 0120	Držátko ubrousku řetízkové, kovové svorky 32 cm	Napkin holder with metal chain; 32 cm	133
285 499 54 7000	Plomba pro sterilizační kontejnery	Seal for sterilizing containers	143

Jmenný rejstřík – český

Alphabetical index – Czech



A			
Adson pinzeta anatomická	68		
Adson pinzeta chirurgická	68		
B			
Babcock svorka chirurgická	46		
Backhaus svorka na prádlo	48		
Backhaus-Clip svorka na prádlo	48		
Barry páka extrakční	25		
Bein páka extrakční	21, 22		
Black dlátko na sklovinu	110, 111		
Black škrabka na zubní kámen	108		
Blumenthal kleště štípací na kosti	16		
Bowmann pátradlo oční	73		
Boynton jehelec oční	50		
Boynton jehelec oční tvrdokov	52		
Brünnings lopatka na jazyk	74		
Buben sterilizační	139, 139		
Buchwald lopatka na jazyk	74		
C			
Castroviejo jehelec	53		
Castroviejo jehelec mikro	53		
Castroviejo nůžky na duhovku	62		
Castroviejo nůžky oční	62		
Cleveland kleště štípací na kosti	16		
Collin kleště na jazyk okénkované	19		
Collin kleště tamponové	19		
Cpátko amalgamu oboustranné	82		
Cpátko kombinované oboustranné	83		
Cpátko kompozitních materiálů	82		
Cpátko kopýtkové	83		
Cpátko kořenové jednostranné	84		
Cpátko kuličkové s hladítkem	87		
Cpátko oboustranné	82–84		
Cpátko oboustranné oválné	82		
Cpátko vlákna do sulku	85		
Crile jehelec jemný	50, 52		
Cushing háček jemný	32		
Č			
Čepelka skalpelová	43		
D			
De Bakey pinzeta atraumatická	69		
De Bakey-Mosquito svorka atraumatická	47		
De Bakey-Pean svorka atraumatická	47		
De Bakey-Rankin svorka atraumatická	47		
Desmarres háček jemný	32		
Dieffenbach skalpel oční	41		
Discoid-Cleoid nástroj na výplně	92		
Dlaha dentální prefabrikovaná	54		
Dláto ploché jemné	28		
Dláto poloklínové jemné	29		
Dláto žlábkové	28		
Dláto žlábkové jemné	29		
Drápek na zubní kámen	106		
Držák	76, 135		
Držátko skalpelových čepelek	42		
Držátko ubrousku řetízkové	133		
Držátko ubrousku UH	133		
Držátko zubního zrcátka	75, 76		
E			
Exkavátor jednostranný	79		
Exkavátor oboustranný	76, 80		
Explorer	101		
F			
Filtr dentální papírový	143		
Filtr dentální textilní	143		
Filtr látkový ke sterilizačnímu bubnu	139		
Filtr mini papírový	143		
Filtr mini textilní	143		
Filtr standardní papírový	143		
Filtr standardní textilní	143		
Filtr teflonový standardní	143		
Filtr teflonový mini	143		
Flohr páka extrakční	22		
Frahm nástroj na modelování výplně	90		
Freer páčidlo na nosní přepážku	20		
Freer páčidlo nosní	20		
Friedman kleště štípací na kosti	16		
Furkační kyreta	105		
G			
Gillies pinzeta chirurgická	68		
Goldman-Fox nůžky na dásně	56		
Gomel nůžky mikro	63		
Gracey kyreta	102, 104		
Graefe pinzeta fixační	70		
Graefe pinzeta oční	70		
H			
Háček na rány	31		
Háček oční	33		
Háček pro plastiku	33		
Hák intraorální	36		
Hák resekční	35		
Halsted-Mosquito svorka na cévy	45		
Hartmann svorka	45		
Heidemann hladítko	89		
Heister rozvěrač úst	37		
Heywood-Smith kleště tamponové	19		
Hladítko oboustranné	88, 89		
Hladítko pružné	88		
Hladítko se cpátkem	86		
I			
Ivory matrice na tvarování	96		
Ivory napínač matric	96		
J			
Jacobson jehelec mikro	53		
Jansen kleště štípací	17		
Jehelec hloubkový	50, 51		
Jehelec s vnitřním uzávěrem	50		
Jennings rozvěrač úst	37		
Jeweler pinzeta	68		
Joseph háček na rány	31		
Joseph pilník	27		
K			
Kazeta pro stomatologické nástroje	76, 135		
Kazeta s držákem	135		

Kelly svorka na cévy	46
Kladívko chirurgické kovové	30
Kladívko laboratorní ocelové	125
Kleště extrakční	11–15
Kleště k odstranění kořenových nástrojů	15
Kleště laboratorní	118, 122
Kleště laboratorní čočkové	118
Kleště laboratorní kuželové	118
Kleště laboratorní oblé	118
Kleště laboratorní ohýbací	119, 120
Kleště laboratorní ploché	118, 119
Kleště laboratorní utahovací	120
Kleště na kelímky	117
Kleště štípací	18
Kleště štípací na drát	117
Kontejner	140
Kontejner dentální	141
Kontejner mini	142
Koš sítový	140–142
Krabička kulatá	135
Krabička na katetry	136
Krabička na umělý chrup	137
Krabička s bočními prohlubněmi	137
Krabička s poklopem	136
Krabička s přihrádkami	136
Krabička s rovným víkem	136
Krabička s vypouklým víčkem	136
Krabička sterilizační	136
Kroužek kovový licí	127, 128

L

Langenbeck hák na rány	35
Langenbeck chránič prstu	36
Langenbeck páčidlo	20
Langenbeck škrabka	26
Le Cron nástroj modelovací	122, 123
Lecluse páka extrakční	25
List k pilce upínací stomatologické	116
Lister kleště tamponové	19
Lister nůžky na obvazy	55
Liston kleště štípací	18
Littauer nůžky pro ligaturu	57
Löbker kleště na jazyk	19
Lopatka na cement	95, 121
Lopatka na míchání otiskovacích hmot	95, 121
Lopatka na sádro	121
Lorna svorka na prádlo	49
Luer kleště štípací na kosti	16, 17
Luniatschek zavadeč dřenů	54
Lžice otiskovací	129, 130
Lžice otiskovací korunková	129
Lžička exkochleační bajonetová	40
Lžička laboratorní	121
Lžička oboustranná	38
Lžička ostrá	39
Lžička ostrá oboustranná	38

M

Mathieu jehelec	50
Mathieu jehelec	52
Mathieu jehelec jemný	52
Matrice pásková	97
Micro-Mosquito svorka na cévy	45
Middeldorpf hák na rány okénkovej	34
Mini Gracey kyreta	103, 104
Mini-Friedman kleště štípací na kosti	16
Mini-Langenbeck háček jemný	32
Mod. Bonn nůžky extra jemné	60
Mosquito-Halsted svorka na cévy	44, 122

N

Nabers furkační sonda	101
Nádobka kovová	135

Nádobka medicínská kovová	135
Nádobka na vatové odpadky	133
Nádobka na vatu s pružinou	133
Nádobka oválná – emitní miska	135
Napínač matric	97
Nástroj modelovací	124
Nástroj na modelování výplně	90, 91, 92
Nástroj na plastické výplně	92
Nástroj na snímání korunek	98
Nástroj na výplně	90, 91
Nástroj na zubní kámen	109
Nástroj na zubní kámen	106
Nástroj pro výplně	90
Nosič amalgamu	81
Noyes nůžky na duhovku	62
Nůž modelovací	122, 123
Nůž na dásen oboustranný	40
Nůž na gingivektomii	40
Nůž na sádro s otvíračem kyvet	121, 122
Nůžky	61
Nůžky chirurgické	59
Nůžky lomené	61
Nůžky mikro	63
Nůžky na dásen	56
Nůžky na korunky	116
Nůžky rovné	61
Nůžky zahnuté	61

O

Obtahovací kamínek na ostření kyret	105
Oehler pinzeta chirurgická	68
Olsen-Hegar jehelec/nůžky	51

P

Páčidlo na nosní přepážku	20
Páka extrakční	23, 25
Pásek separační diamantovaný	93
Pásek separační hladký	93
Pátradlo zubní háčkové	73
Pátradlo zubní obloukové	73
Pátradlo zubní vyhnuté	73, 76
Peers svorka na prádlo	49
Pilník	27
Pilník diamantovaný	112
Pinzeta anatomická	65
Pinzeta cévní atraumatická	69
Pinzeta chirurgická	67
Pinzeta laboratorní	115
Pinzeta na kořenové čípky	64
Pinzeta šicí	67
Pinzeta zkřížená	115
Pinzeta zkřížená se šroubovákem	115
Pinzeta zubní	64, 76, 122
Pinzeta zubní chirurgická	64
Pistole na amalgam plastová	94
Pistole na amalgam s kovovým pístem	94
Planátor	91
Plomba pro sterilizační kontejnery	143
Podložka pod licí kroužky	127
Podložka silikonová	144
Přecechtěl škrabka nosní	26

Q

Quinby nůžky na dásen	56
-----------------------	----

R

Rám napínací	140–142
Rám upínací pilky stomatologické	116
Reynolds nůžky preparační	57
Roeder svorka na prádlo	49
Rochester-Pean svorka na cévy	46
Roser-König roztvárač úst	37

Rouška textilní zelená	144
Roux hák	35
Ryder jehelec	51

Zrcátka zubní zvětšovací

75, 76

S

Sanvenero nůžky preparační	57
Sapin nástroj na modelování výplní	90
Scaler oboustranný	104, 105
Semken pinzeta anatomická	68
Schlemmer páka extrakční	23
Síto oddělovací	140
Sonda parodontologická	101
Sonda parodontologická s pátradlem	101
Soubor otiskovacích lžic dětských	130
Soubor otiskovacích lžic perforovaných	129
Soubor parodontologických nástrojů	104
Soubor pro zubní techniky	122
Soubor základních stomatologických nástrojů	76
Spencer nůžky pro ligaturu	57
Srpek na zubní kámen	76, 106, 107
Standard nůžky chirurgické	58, 59
Standard pinzeta anatomická	66
Standard pinzeta chirurgická	66
Standard pinzeta chirurgická jemná	67
Stellbrink kleště štípací na kosti	16
Svorka na separační pásky	93

Š

Škrabka na operaci slzného vaku	26
Škrabka na zubní kámen	107, 108
Špinar páka extrakční	24
Štítek identifikační	143

T

Tácek	137
Tácek dentální	137
Tácek hluboký	137
Tácek s drážkami	137
Testovací tyčinka PMMA	105
Tohoku-Japan svorka na prádlo	49
Toulec na kleště	134
Toulec na pinzety	134
Toulec na podávkové kleště	134
Třmen pro kyvety	126

V

Vana neperforovaná	140–142
Vana perforovaná	140–142
Víko neperforované	140–142
Víko ochranné	140
Víko perforované	140–142
Vložka síťová	142

W

Wagner nůžky jemné	60
Walton nůžky jemné	60
West dláto žlábkové	28
White páka extrakční	24, 25
Whitehead rozvěrač úst	37
Wiland nástroj na výplně	90
Williger páčidlo	20
Williger škrabka	26

Z

Zámek bezpečnostní plastový	143
Zavaděč retrakčních vláken	85
Zesilovací mřížka	128
Zešikmovač gingiválních okrajů	108
Zrcátko intraorální	74
Zrcátko zubní ploché	75

A

Adson forceps	68
Amalgam condenser	91
Amalgam gun	94

B

Babcock tissue seizing forceps	46
Backhaus towel forceps	48
Backhaus-Clip towel forceps	48
Barry root elevator	25
Bein root elevator	21, 22
Black enamel chisel	110, 111
Black scaler	108, 111
Blade of stomatological saw	116
Blumenthal bone ronguers	16
Bone curette	40
Bone curette double-faced	38
Bone rongeurs	18
Bottom non perforated	140–142
Bottom perforated	140–142
Bowl	135
Bowmann eye probe	73
Box	136, 137
Box for denture	137
Box round	135
Boynton eye needle holder	50
Brünnings tongue spatula	74
Buchwald tongue spatula	74

C

Carrier hollow handle	81
Cassette	76, 135
Cassette with holder	135
Casting ring	127, 128
Castroviejo eye scissors	62
Castroviejo iris scissors	62
Castroviejo micro-needle holder	53
Castroviejo needle holder	53
Cement spatula	95, 121
Chisel	28, 29
Clap for flasks	126
Cleveland bone ronguers	16
Cloth green	146
Collin dressing forceps	19
Collin tongue holding forceps	19
Container	142
Cotton wool box with spring	133
Cotton wool container	133
Crile needle holder	50, 52
Cross-action forceps	115
Cross-action forceps with screwdriver	115
Crown impression tray	129
Crown remover	98
Crown scissors	116
Crucible forceps	117
Cushing delicate hook	32
Cutting instrument	109

D

De Bakey atrauma forceps	69
De Bakey-Mosquito atrauma forceps	47
De Bakey-Pean atrauma forceps	47
De Bakey-Rankin atrauma forceps	47
Delicate hook	31
Dental container	141

Dental forceps	64, 76, 122
Dental mirror	75
Dental probe	73, 76
Dental tray	137
Desmarres delicate hook	32
Diamond file	112
Dieffenbach knife	41
Discoïd-Cleoid filling instrument	92
Dissection micro scissors	63
Divider	142
Drape retainer dental	140–142

E

Excavator curved	79
Excavator double-faced	76, 80
Excavator straight	79
Explorer	101
Extraction forceps	11–15
Eye hook	33

F

Fibre filling instrument	85
Filling instrument	82–84, 90, 91
Filter; paper	143
Filter; textile	143
Flohr root elevator	22
Forceps for extraction of root instruments	15
Forceps quiver with stand	134
Frahm filling instrument	90
Frahm modelling instrument	90
Frame of stomatological saw	116
Freer nasal elevator	20
Freer septum elevator	20
Friedman bone ronguers	16
Furcation curette	105

G

Gillies tissue forceps	68
Gingival margin trimmer	108
Gingivectomy knife	40
Goldman-Fox scissors	56
Gomel dissection micro scissors	63
Gouge	28, 29
Gouge grooved	28
Gracey curette	102, 104
Graefe eye forceps	70
Graefe fixation forceps	70
Gum knife mutual	40
Gum scissors	56

H

Halsted-Mosquito artery forceps	45
Hartmann forceps	45
Heidemann spatula	89
Heister mouth retractor	37
Heywood-Smith sponge holding forceps	19
Holder	76, 135

I

Identification label	143
Impression tray	129, 130
Intraolar hook	36
Intraoral mirror	74
Ivory matrix band	96

Ivory matrix retainer 96
Ivory separator 96

J

Jacobson micro-needle holder 53
Jansen mastoid forceps 17
Jennings mouth retractor 37
Jeweler forceps 68
Joseph delicate hook 31
Joseph rasp 27

K

Kelly artery forceps 46

L

Laboratory bending forceps 120
Laboratory forceps 115, 118, 119, 122
Laboratory mallet 125
Laboratory spoon 121
Laboratory tighten forceps 120
Lachrymal sac raspatory 26
Langenbeck elevator 20
Langenbeck finger protector 36
Langenbeck raspatory 26
Langenbeck retractor 35
Le Cron modelling instrument 122, 123
Lecluse root elevator 25
Lid non perforated 140–142
Lid perforated 140–142
Lister bandage scissors 55
Lister sinus forceps 19
Liston bone rongeurs 18
Littauer ligature scissors 57
Löbker tongue holding forceps 19
Lorna towel forceps 49
Luer bone rongeurs 16, 17
Luniatschek drain introducer 54

M

Mathieu needle holder 50, 52
Matrix band 97
Mesh strengthener 128
Micro-Mosquito artery forceps 45
Middeldorpf retractor 34
Mini Gracey curette 103, 104
Mini-Friedman bone ronguers 16
Mini-Langenbeck delicate hook 32
Mirror handle 75, 76
Mixing spatula 95, 121
Mod. Bonn extra delicate scissors 60
Modelling instrument 90–92, 124
Modelling knife 122, 123
Mosquito-Halsted artery forceps 44, 122
Mouth mirror 75, 76

N

Nabers furcation probe 101
Napkin holder 133
Needle holder 50, 51
Non-traumatic forceps 69
Noyes iris scissors 62

O

Oehler tissue forceps 68
Olsen-Hegar needle holder/scissors 51
Operating scissors 59

P

Paper filter 143
Paper label 143
Peers towel forceps 49
Periodontal and dental probe 101
Periodontal probe 101
Plaster knife 121, 122
Plaster spatula 121
Plastic filling instrument 92
Plastic filling instrument 88, 89, 92
Plastic filling instrument – carrier 81
Plastic filling instrument – plugger 82–84, 91
Plastic filling instrument – spatula 88, 89, 92
Plastic filling instrument – spatula-plugger 86, 87
Plastic hook 33
Plastic security seal 143
Plastic test stick 105
Prefabricated plate 54
Přecechtěl nasal raspatory 26

Q

Quinby gum scissors 56
Quiver for forceps 134

R

Rasp 27
Resection hook 35
Retentive fibre instrument 85
Reynolds dissecting scissors 57
Roeder towel forceps 49
Rochester-Pean artery forceps 46
Root elevator 23–25
Root suppository forceps 64
Roser-König mouth retractor 37
Roux retractor 35
Ryder needle holder 51

S

Safety lid 140
Sanvenero dissecting scissors 57
Sapin filling instrument hollow handle 90
Sapin modelling instrument 90
Scaler 76, 106–108
Scaler double-faced 104–108
Scalpel blade 43
Scalpel handle 42
Scissors 61
Seal for sterilizing containers 143
Semken dissecting forceps 68
Separative strip diamond 93
Separative strip smooth 93
Septum nasal elevator 20
Set for dental technicians 122
Set of basic stomatological instruments small 76
Set of impression perforated trays 129
Set of impression perforated trays for children 130
Set of mini periodontal instruments 104
Set of periodontal instruments 104
Sharp spoon 39
Sharpening stone for curretes 105
Schlemmer root elevator 23
Silicon mat 144
Small set container 142
Spatula – filling instrument 86, 88, 89
Spencer ligature scissors 57
Standard operating scissors 58, 59
Stellbrink bone ronguers 16
Sterilization box 136
Sterilization drum 138, 139
Strip clamp 93
Surgical mallet 30
Suture tying forceps 67
Špinar root elevator 24

T























Teflon filter standard	143
Textile filter for sterilization drum	139
Textile filter mini	143
Textile filter standard	143
Tissue forceps	66, 67
Tissue forceps	65–67
Tohoku-Japan towel forceps	49
Tray	137
Tweezer quiver with stand	134

U

Universal retainer	97
--------------------	----

W

Wagner fine scissors	60
Walton fine scissors	60
Washer for casting rings	127
West gouge grooved	28
Whitehead mouth retractor	37
Wiland amalgam carver	90
Williger elevator	20
Williger raspatory	26
Wire base	142
Wire basket	140–142
Wire cutting forceps	117

	použit do	use by
	datum výroby	date of manufacture
	výrobce	manufacturer
	nepoužívat opětovně	do not re-use
	neprovádět opětovnou sterilizaci	do not re-sterilize
	nepoužívat, jestliže je balení poškozeno	do not use if package is damaged
	otevřené balení nebude nahrazeno	opened packages are not replaced
	set, souprava	assortment
	seznamte se s návodem k použití kvůli důležitým varovným informacím	caution, consult accompanying documents
	nesterilní	non sterile
	doporučené otáčky za minutu, doporučená frekvence otáčení XXX-XXX min ⁻¹	recommended rotation speed
	kód dávky	batch code
	katalogové číslo	catalogue number
	množství	quantity
	označuje kontrolní materiál	control (indicates a control material)
	sterilní	sterile
	sterilizováno ozářením	sterilised using irradiation
	sterilizováno ethylenoxidem	sterilised using ethylene oxide
	sterilizováno aseptickou technologií	sterilised using aseptic processing techniques
	diagnostický zdravotnický prostředek in vitro	in vitro diagnostic medical device
	globální nomenklatura zdravotnických prostředků	global medical device nomenclature code
	seznamte se s návodem k použití	consult instructions for use

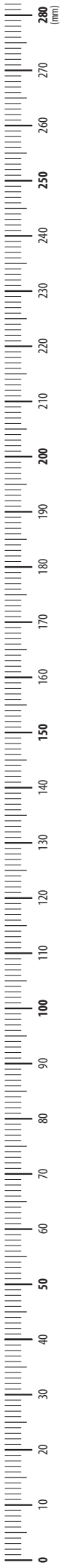

A series of horizontal lines extending across the page, providing a template for writing or drawing. The lines are evenly spaced and correspond to the millimeter markings on the ruler.



MEDIN, a.s.
Vlachovická 619
Nové Město na Moravě
CZ 592 31
Czech Republic
IČ 43378030
DIČ CZ43378030

www.medin.cz
www.medin.eu

PRODEJ ČESKÁ REPUBLIKA
tel.: 566 684 327
fax: 566 684 384
e-mail: prodej@medin.cz

EXPORT
phone: +420 566 684 336
fax: +420 566 684 385
e-mail: export@medin.cz

